

aerospace  
climate control  
electromechanical  
filtration  
fluid & gas handling  
hydraulics  
**pneumatics**  
process control  
sealing & shielding

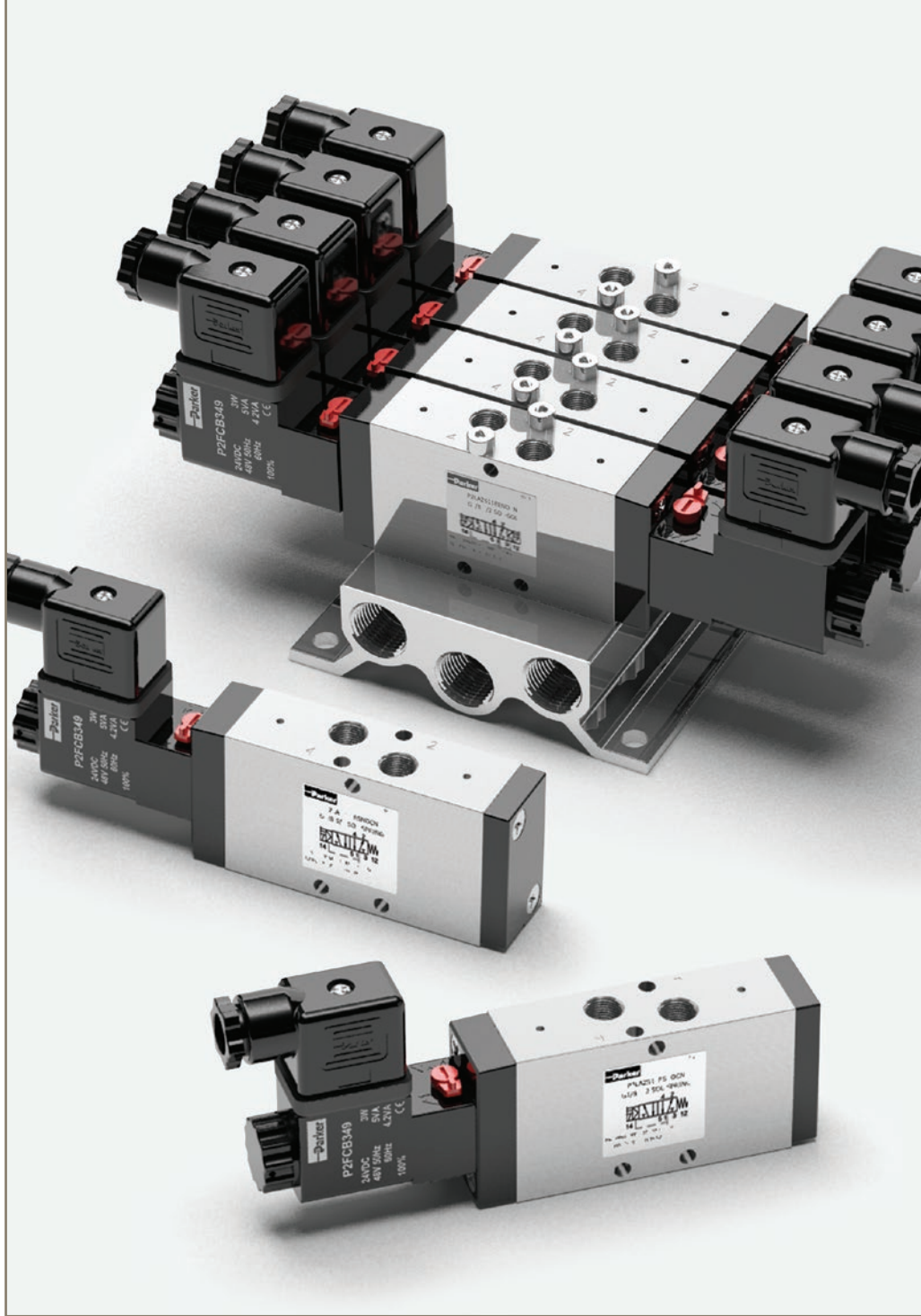

# Pneumatic Valves Viking Lite Series

G1/8 - G3/8 body ported

Catalogue PDE2658TCUK 11/2021



ENGINEERING YOUR SUCCESS.

**Directional control valves**

Material Specification.....	3 - 6
Flow Characteristics.....	7
Viking Lite Part Number System.....	8
Main Data Electrically Actuated Directional Control Valves.....	9
Dimensions - P2LAZ / P2LBZ / P2LCZ.....	10 - 15
P2LA, Accessory Order Codes .....	17
P2LB, Accessory Order Codes .....	16 - 18
Manifold Dimensions.....	16 - 18
Solenoid Valves - 22mm.....	19
Solenoid Valves Technical Data - 22mm.....	20
Solenoid Connectors + Cable Plugs.....	20



**Important !**  
 Before carrying out any service work, ensure that the valve and manifold have been vented. Remove the primary supply air hose to ensure total disconnection of the air supply before dismantling valves or blank connection blocks.



**NB !**  
 All technical data in this catalogue is typical only.  
 The air quality is decisive for the valve life: see ISO 8573.



**WARNING**

FAILURE OR IMPROPER SELECTION OR IMPROPER USE OF THE PRODUCTS AND/OR SYSTEMS DESCRIBED HEREIN OR RELATED ITEMS CAN CAUSE DEATH, PERSONAL INJURY AND PROPERTY DAMAGE.  
 This document and other information from Parker Hannifin Corporation, its subsidiaries and authorized distributors provide product and/or system options for further investigation by users having technical expertise. It is important that you analyze all aspects of your application and review the information concerning the product or system in the current product catalog. Due to the variety of operating conditions and applications for these products or systems, the user, through its own analysis and testing, is solely responsible for making the final selection of the products and systems and assuring that all performance, safety and warning requirements of the application are met. The products described herein, including without limitation, product features, specifications, designs, availability and pricing, are subject to change by Parker Hannifin Corporation and its subsidiaries at any time without notice.

**SALE CONDITIONS**

The items described in this document are available for sale by Parker Hannifin Corporation, its subsidiaries or its authorized distributors. Any sale contract entered into by Parker will be governed by the provisions stated in Parker's standard terms and conditions of sale (copy available upon request).

# Viking Lite ...

robust, versatile high performance  
with long service life

The Viking Lite valve range is robust, versatile and combines high performance with compact installation dimensions. The choice of G1/8, G1/4 or G3/8 port sizes provide large flow capacity, short change-over times for maximum productivity and the low change-over pressure is an important characteristic of this valve range.

Designed to operate with pressures up to 10 bar in temperatures -10°C to +50°C.

## Viking Lite range

**P2LAZ, G1/8 - Cv = 0.6**

**P2LBZ, G1/4 - Cv = 1.5**

**P2LCZ, G3/8 - Cv = 2.5**

### Wear compensating system

Viking Lite valves are fitted with dynamic bi-directional spool seals suitable for pressures up to 10 bar, in ambient temperatures -10°C to +50°C. Under pressure radial expansion of the seal occurs to maintain sealing contact with the valve bore.

This sealing method reduces friction gives lower pilot pressures, providing fast response and less wear. Valves do not require lubrication in operation but they can also be installed in systems that are lubricated.



Wear Compensating System

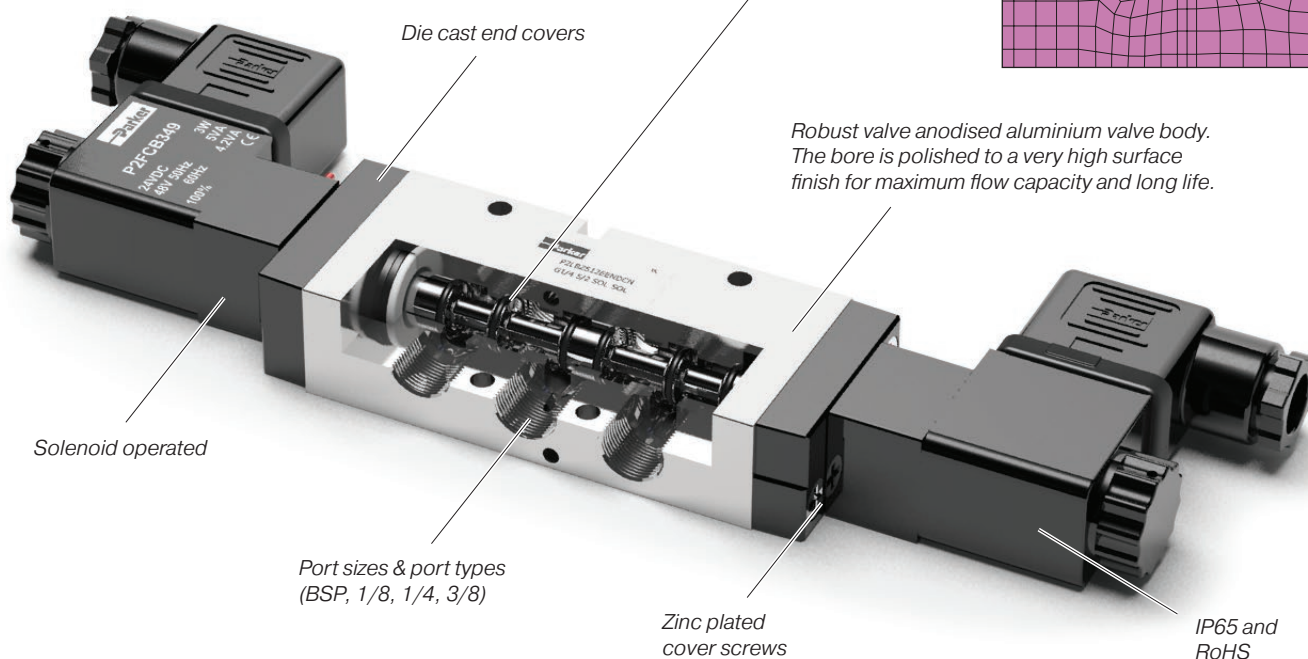
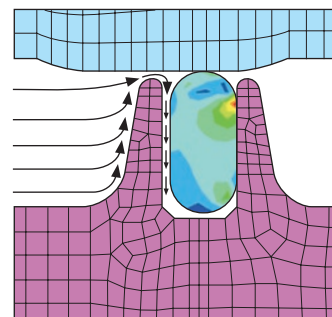

# Viking Lite ...

rust and corrosion resistant,  
high reliability with flexible installation

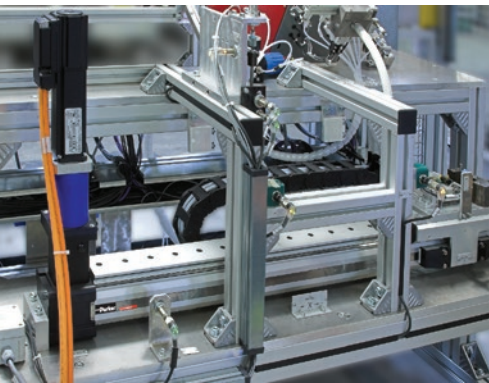

### Rust and corrosion resistant designs.

Viking Lite valves are made of anodized aluminium, for good corrosion resistance.

The smooth design, with no dirt-collecting pockets, makes the valve suitable for most environments.

### High reliability

Viking Lite valves easily comply with the requirements for the component reliability in accordance with EU Machinery Directive standards EN292-2 and EN983. The valves are designed for use with or without supplementary lubrication.

### Compact dimensions for flexibility in installations

Compact dimensions, direct body porting and integral mounting holes are all features of the Viking Lite range.

In addition to single valve installation, the Viking Lite valves may be installed on manifolds so that the valves have a common supply and manifolded exhausts.

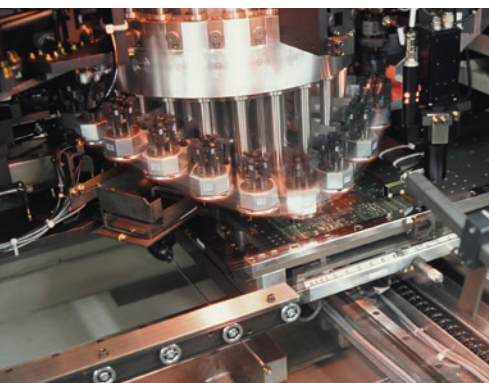

### Manifold bar installation

A manifold bar, with common ducts for ports 1, 3 and 5 gives simple, time saving and easily serviced installation. Manifold bars are available in several different sizes, with space for between 2 and 14 valves.

### Pressure bar installation

A pressure bar for common primary air supply gives a simple, robust, time saving and easily serviced installation. When pressure bars are used, restrictor-silencers can be installed in the exhaust ports of each valve, for individual adjustment of cylinder/air motor speed. Pressure bars are available in a number of different sizes, with space ranging from 2 to 10 valves.

### Extreme applications

For extreme applications, -40 degrees and up to 16 bar pressure use

### VikingXtreme valves :

see catalogue PDE2569TCUK

## Directional control valves

### Working medium, air quality

Working medium: Dry, filtered compressed air to ISO 8573-1 class 3.4.3.

#### Recommended air quality for valves

For best possible service life and trouble free operation, ISO 8573-1 quality class 3.4.3 should be used. This means 5µm filter (standard filter) dew point +3°C for indoor operation (a lower dew point should be selected for outdoor operation) and oil concentration 1.0 mg oil/m<sup>3</sup>, which is what a standard compressor with a standard filter gives.

#### ISO 8573-1 quality classes

Quality class	Pollution		Water max. press. dew point (°C)	Oil max. concentration (mg/m <sup>3</sup> )
	particle size (µm)	max. concentration (mg/m <sup>3</sup> )		
1	0,1	0,1	-70	0,01
2	1	1	-40	0,1
3	5	5	-20	1,0
4	15	8	+3	5,0
5	40	10	+7	25
6	-	-	+10	-

#### Typical cylinder speeds which can be achieved with Viking valves and different tube sizes.

In the chart below you can find the suitable valves, tubes etc. for each cylinder size. If you have a tube length over 2m, choose one tube size larger than in the chart.

Following data is valid:

- Supply pressure : min 7.0 bar
- Regulator pressure setting : 6.0 bar
- Pipe length between air treatment unit and valve : max 1m
- Pipe length between valve and cylinder : max 2m

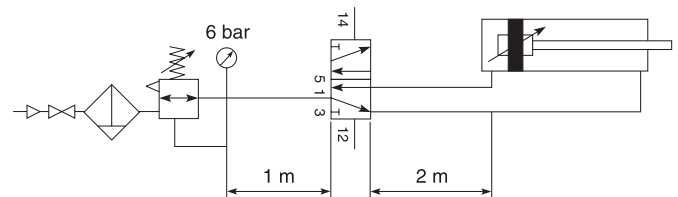

Cylinder bore	<20	20-32	40-50	63	80	100	125
Cylinder port	M5	G1/8	G1/4	G3/8	G3/8	G1/2	G1/2
Tubing Ext/Int	4/2.7	6/4	8/6	10/8	10/8	12/9	14/11
			6/4	8/6	12/9	14/11	
P2LAZ	G1/8	G1/8	G1/8	G1/8	G1/8		
P2LBZ	G1/4	G1/4	G1/4	G1/4	G1/4	G1/4	
P2LCZ			G3/8	G3/8	G3/8	G3/8	G3/8

- Cylinder speed < 0,5 m/s
- Cylinder speed < 1 m/s
- Oversized
- Cylinder speed > 1 m/s

**Directional control valves****Material specification****P2LAZ****Valve**

Valve body	Anodised aluminium
End covers	Anodised aluminium
Spool	Aluminium
Piston	Acetal plastic/ Anodised aluminium
End cover sealings	Nitrile rubber
End cover screws	Zinc plated steel
Springs	Stainless steel
Mounting screws for solenoid	Stainless steel
Spool seals	Nitrile
Pilot adaptor	Acetal plastic

**Accessories**

Manifold bar	Anodised aluminium
Pressure bar	Anodised aluminium

**P2LCZ****Valve**

Valve body	Anodised aluminium
End covers	Anodised aluminium
Spool	Aluminium
Piston	Acetal plastic/ Anodised aluminium
End cover sealings	Nitrile rubber
End cover screws	Zinc plated steel
Springs	Stainless steel
Mounting screws for solenoid	Stainless steel
Spool seals	Nitrile
Pilot adaptor	Acetal plastic

**P2LBZ****Valve**

Valve body	Anodised aluminium
End covers	Anodised aluminium
Spool	Aluminium
Piston	Acetal plastic/ Anodised aluminium
End cover sealings	Nitrile rubber
End cover screws	Zinc plated steel
Springs	Stainless steel
Mounting screws for solenoid	Stainless steel
Spool seals	Nitrile
Pilot adaptor	Acetal plastic

**Accessories**

Manifold bar	Anodised aluminium
Pressure bar	Anodised aluminium

## Directional control valves

### Flow characteristics

Flow capacities in accordance with ISO6358

All pressures = effective pressure

The curves in the diagram below are typical only

#### Technical Data P2LAZ

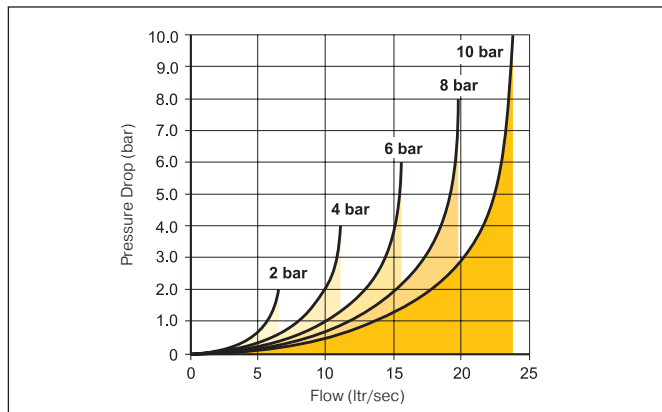

Port size	G1/8
Maximum Operating pressure	10 bar
Working temperature.	-10°C to +50°C
Flow (acc. to ISO 6358)	$c = 2.2 \text{ NI/s} \times \text{bar}$ $b = 0.3$ $Q_n = 10.1 \text{ l/s}$ $Q_{max} = 15.6 \text{ l/s}$ $C_v = 0.6$

#### Technical Data P2LBZ

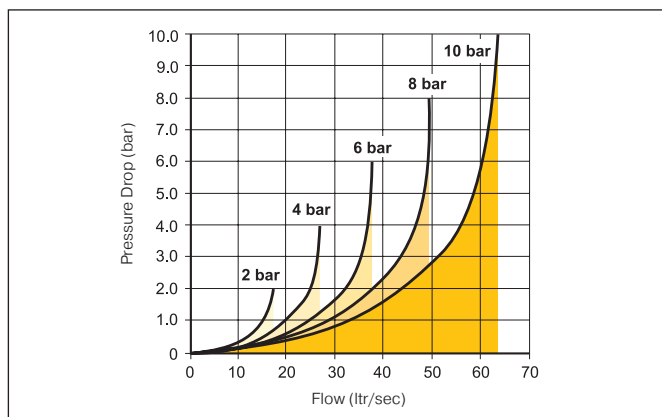

Port size	G1/4
Maximum Operating pressure	10 bar
Working temperature.	-10°C to +50°C
Flow (acc. to ISO 6358)	$c = 5.4 \text{ NI/s} \times \text{bar}$ $b = 0.3$ $Q_n = 24.6 \text{ l/s}$ $Q_{max} = 37.8 \text{ l/s}$ $C_v = 1.5$

#### Technical Data P2LCZ

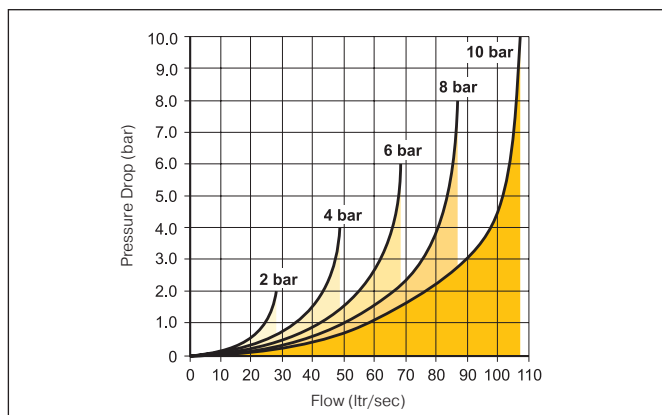

Port size	G3/8
Maximum Operating pressure	10 bar
Working temperature.	-10°C to +50°C
Flow (acc. to ISO 6358)	$c = 9.7 \text{ NI/s} \times \text{bar}$ $b = 0.3$ $Q_n = 41.5 \text{ l/s}$ $Q_{max} = 68.3 \text{ l/s}$ $C_v = 2.5$

**Directional control valves**

**Viking Lite Part Number System**

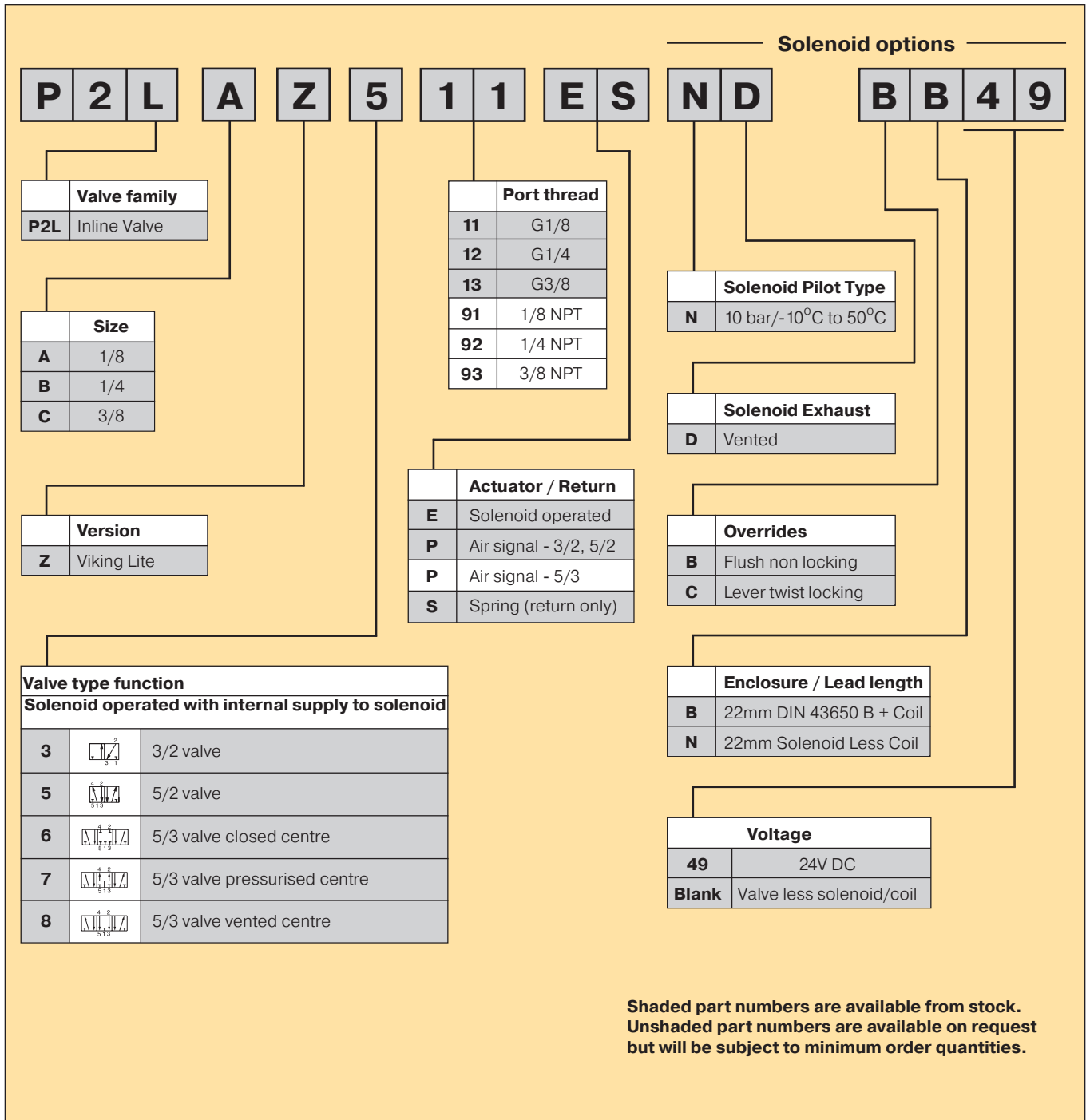



## Directional control valves

### Solenoid operated directional control valves

Internal supply to solenoid valve(s) via port 1.

Max operating pressure 10 bar, temperature range -10°C to +50°C

#### 3/2 valves, internal air, standard temperature

Symbol	Size	Actuation	Return	Min Operating Pressure (bar)	Changeover time (ms) at 6 bar @20°C actua./return	Weight Kg	Order code Without coil	Order code With 24V DC (22mm coil)
	G1/8	Air signal	Air signal	1.5	5/5	0.18	<b>P2LAZ311PP</b>	
	G1/4			1.5	6/6	0.18	<b>P2LBZ312PP</b>	
	G3/8			1.5	8/8	0.36	<b>P2LCZ313PP</b>	
	G1/8	Air signal	Spring	3.0	8/15	0.16	<b>P2LAZ311PS</b>	
	G1/4			3.0	10/20	0.16	<b>P2LBZ312PS</b>	
	G3/8			3.0	10/30	0.35	<b>P2LCZ313PS</b>	
	G1/8	Electric signal	Electric signal	1.5	10/10	0.18	<b>P2LAZ311EENDCN</b>	<b>P2LAZ311EENDCB49</b>
	G1/4			1.5	12/12	0.18	<b>P2LBZ312EENDCN</b>	<b>P2LBZ312EENDCB49</b>
	G3/8			1.5	17/17	0.36	<b>P2LCZ313EENDCN</b>	<b>P2LCZ313EENDCB49</b>
	G1/8	Electric signal	Spring	3.0	15/35	0.16	<b>P2LAZ311ESNDCN</b>	<b>P2LAZ311ESNDCB49</b>
	G1/4			3.0	18/45	0.16	<b>P2LBZ312ESNDCN</b>	<b>P2LBZ312ESNDCB49</b>
	G3/8			3.0	27/75	0.35	<b>P2LCZ313ESNDCN</b>	<b>P2LCZ313ESNDCB49</b>

#### 5/2 valves, internal air, standard temperature

Symbol	Size	Actuation	Return	Min Operating Pressure (bar)	Changeover time (ms) at 6 bar @20°C actua./return	Weight Kg	Order code Without coil	Order code With 24V DC (22mm coil)
	G1/8	Air signal	Air signal	1.5	5/5	0.18	<b>P2LAZ511PP</b>	
	G1/4			1.5	6/6	0.18	<b>P2LBZ512PP</b>	
	G3/8			1.5	8/8	0.36	<b>P2LCZ513PP</b>	
	G1/8	Air signal	Spring	3.0	8/15	0.16	<b>P2LAZ511PS</b>	
	G1/4			3.0	10/20	0.16	<b>P2LBZ512PS</b>	
	G3/8			3.0	10/30	0.35	<b>P2LCZ513PS</b>	
	G1/8	Electric signal	Electric signal	1.5	10/10	0.19	<b>P2LAZ511EENDCN</b>	<b>P2LAZ511EENDCB49</b>
	G1/4			1.5	12/12	0.21	<b>P2LBZ512EENDCN</b>	<b>P2LBZ512EENDCB49</b>
	G3/8			1.5	17/17	0.44	<b>P2LCZ513EENDCN</b>	<b>P2LCZ513EENDCB49</b>
	G1/8	Electric signal	Spring	3.0	15/35	0.17	<b>P2LAZ511ESNDCN</b>	<b>P2LAZ511ESNDCB49</b>
	G1/4			3.0	18/45	0.20	<b>P2LBZ512ESNDCN</b>	<b>P2LBZ512ESNDCB49</b>
	G3/8			3.0	27/75	0.43	<b>P2LCZ513ESNDCN</b>	<b>P2LCZ513ESNDCB49</b>

#### 5/3 valves, internal air, standard temperature

Symbol	Size	Actuation	Return	Min Operating Pressure (bar)	Changeover time (ms) at 6 bar @20°C actua./return	Weight Kg	Order code Without coil	Order code With 24V DC (22mm coil)
	G1/8	Electric/Electric	Self centring	3.0	18/40	0.26	<b>P2LAZ611EENDCN</b>	<b>P2LAZ611EENDCB49</b>
	G1/4		Closed	3.0	22/55	0.28	<b>P2LBZ612EENDCN</b>	<b>P2LBZ612EENDCB49</b>
	G3/8		Centre	3.0	30/90	0.60	<b>P2LCZ613EENDCN</b>	<b>P2LCZ613EENDCB49</b>
	G1/8	Electric/Electric	Self centring	3.0	18/40	0.26	<b>P2LAZ711EENDCN</b>	<b>P2LAZ711EENDCB49</b>
	G1/4		Presurised	3.0	22/45	0.28	<b>P2LBZ712EENDCN</b>	<b>P2LBZ712EENDCB49</b>
	G3/8		Centre	3.0	30/90	0.60	<b>P2LCZ713EENDCN</b>	<b>P2LCZ713EENDCB49</b>
	G1/8	Electric/Electric	Self centring	3.0	18/40	0.26	<b>P2LAZ811EENDCN</b>	<b>P2LAZ811EENDCB49</b>
	G1/4		Vented	3.0	22/45	0.28	<b>P2LBZ812EENDCN</b>	<b>P2LBZ812EENDCB49</b>
	G3/8		Centre	3.0	30/90	0.60	<b>P2LCZ813EENDCN</b>	<b>P2LCZ813EENDCB49</b>

**Dimensions**

**P2LAZ 3/2**  
Air / Air

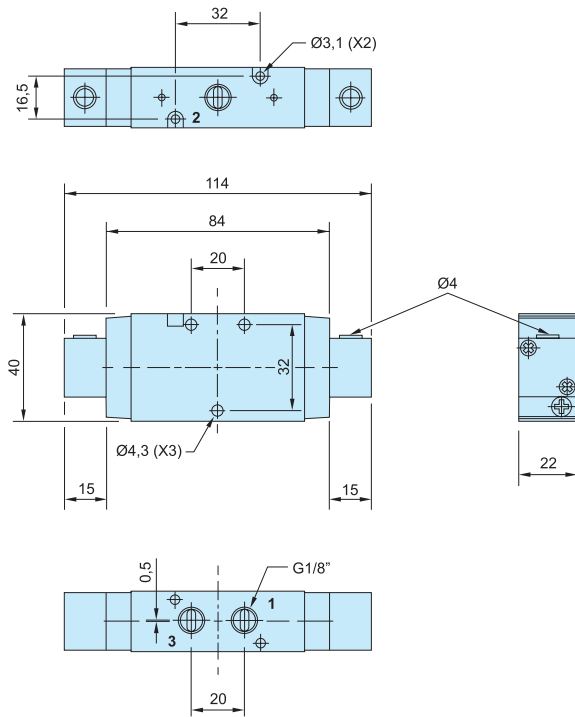

**P2LAZ 3/2**  
Air / Spring

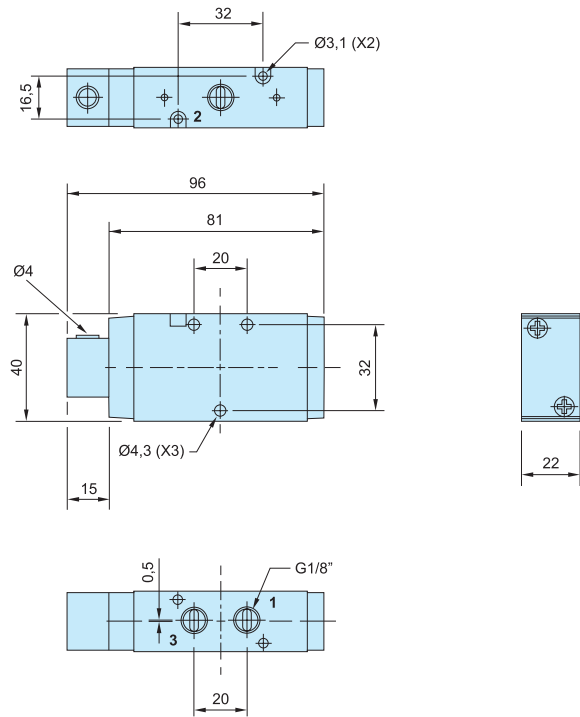

**P2LAZ 3/2**  
Solenoid / Solenoid

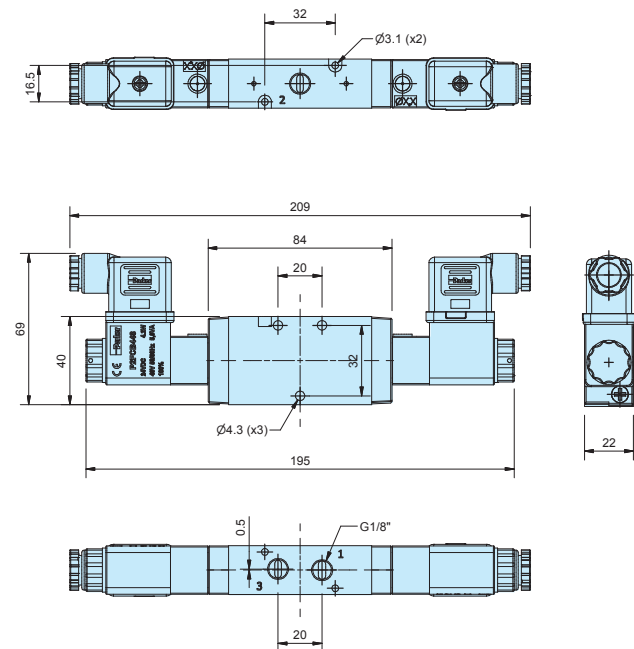

**P2LAZ 3/2**  
Solenoid / Spring

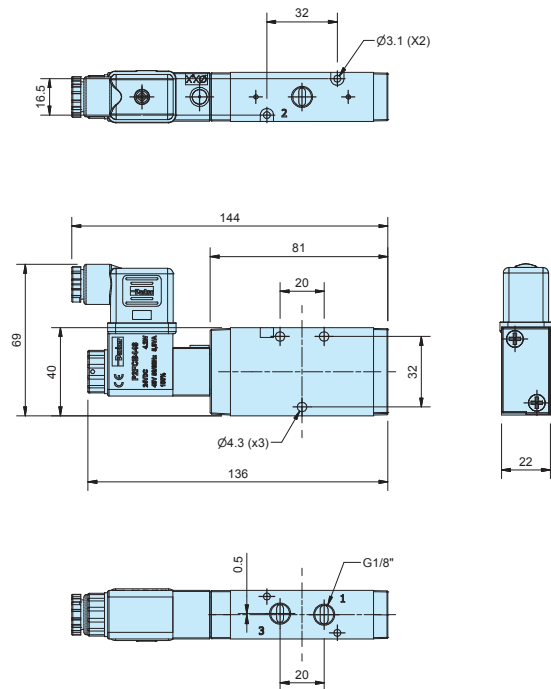

**Solenoid valves**

Solenoid valves and cable plugs must be ordered separately.

One pilot valve is required for each E (NDCN only) in the valve order code.

**Directional control valves**

**Dimensions**

**P2LAZ 5/2**  
Solenoid / Solenoid

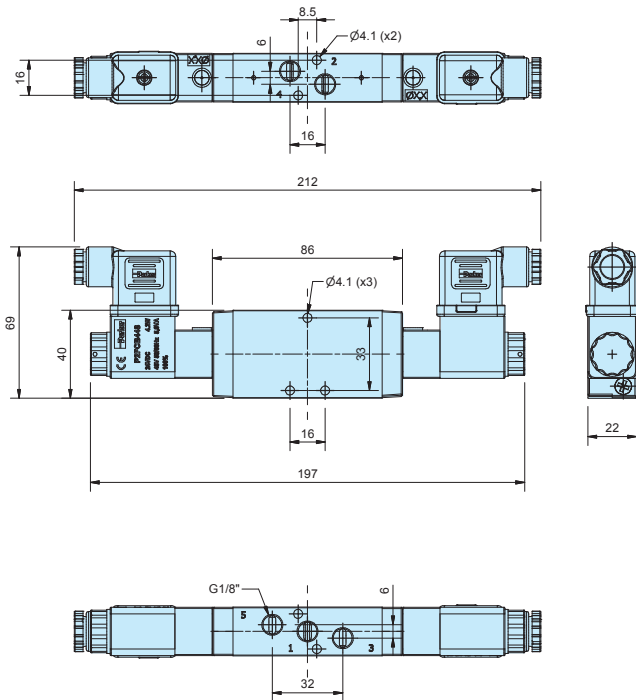

**P2LAZ 5/2**  
Solenoid / Spring

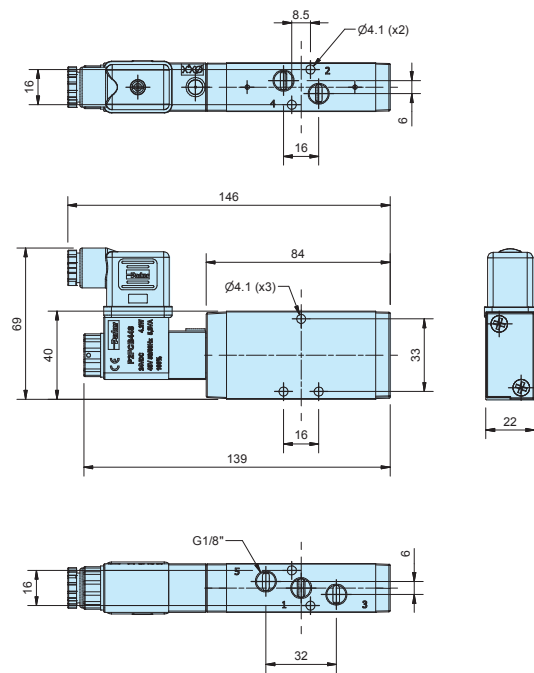

**P2LAZ 5/3**  
Solenoid / Solenoid

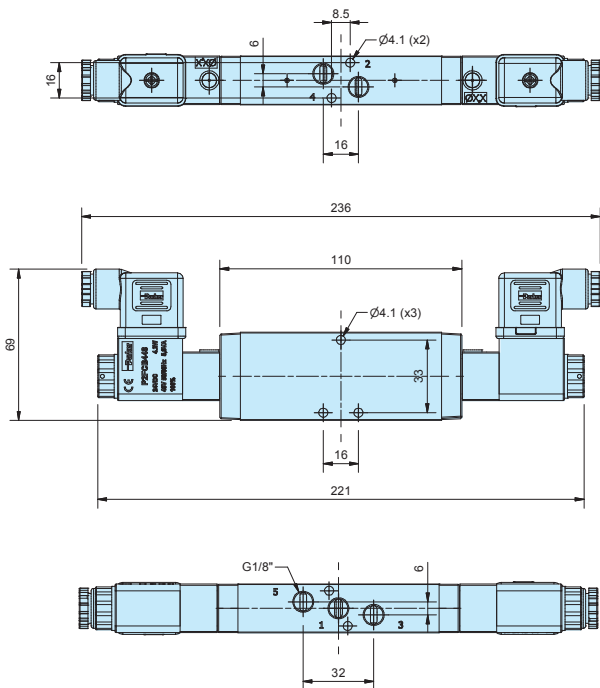

**Solenoid valves**  
Solenoid valves and cable plugs must be ordered separately.  
One pilot valve is required for each E (NDCN only) in the valve order code.

**Directional control valves**

**Dimensions**

**P2LBZ 3/2**  
Air / Air

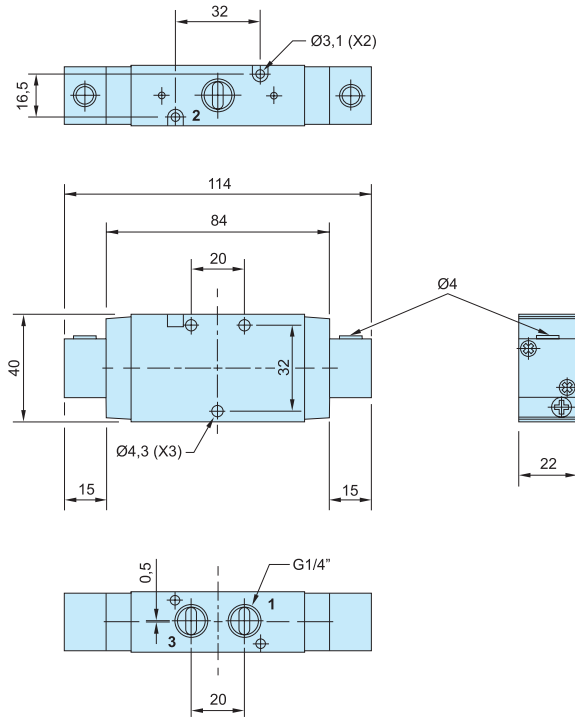

**P2LBZ 3/2**  
Air / Spring

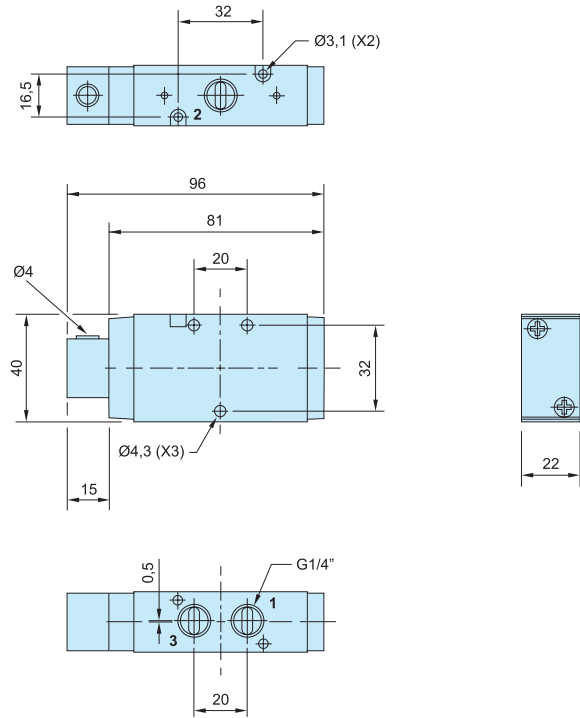

**P2LBZ 3/2**  
Solenoid / Solenoid

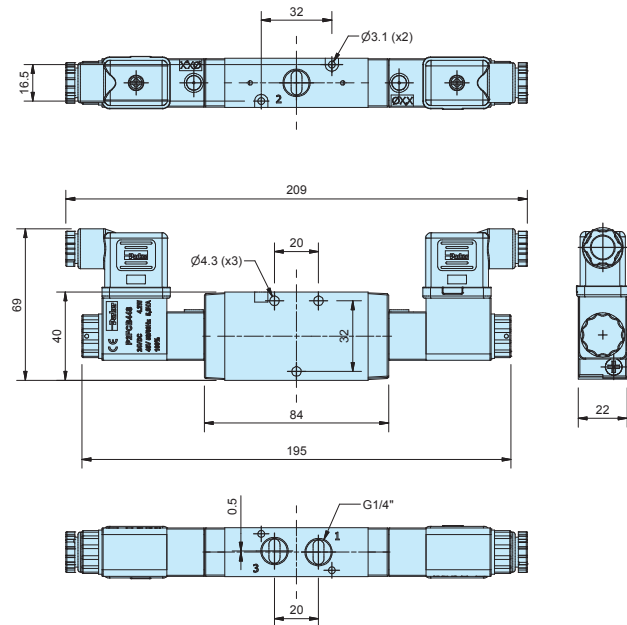

**P2LBZ 3/2**  
Solenoid / Spring

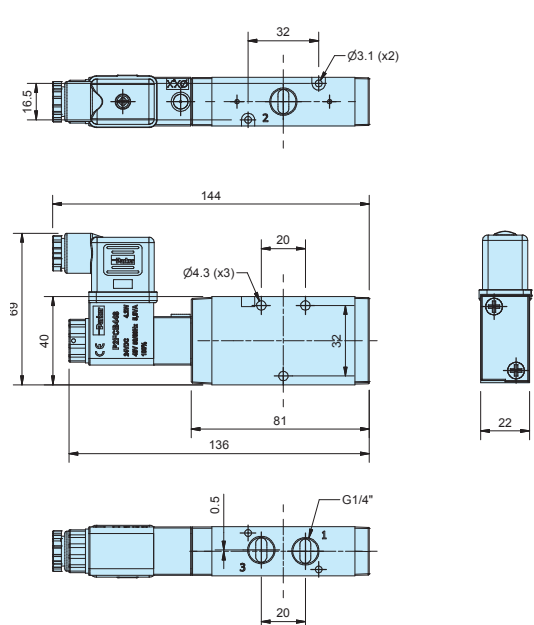

**Solenoid valves**

Solenoid valves and cable plugs must be ordered separately.  
One pilot valve is required for each E (NDCN only) in the valve order code.

**Directional control valves**

**Dimensions**

**P2LBZ 5/2**  
Solenoid / Solenoid

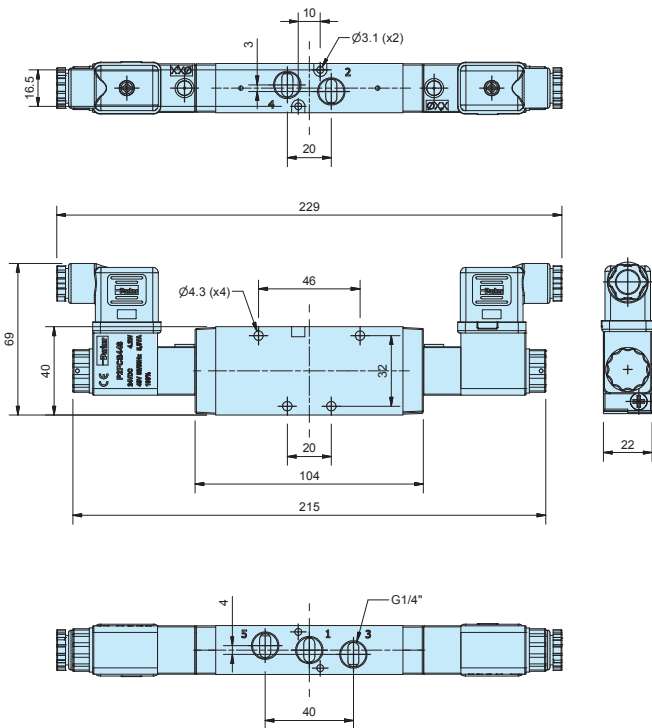

**P2LBZ 5/2**  
Solenoid / Spring

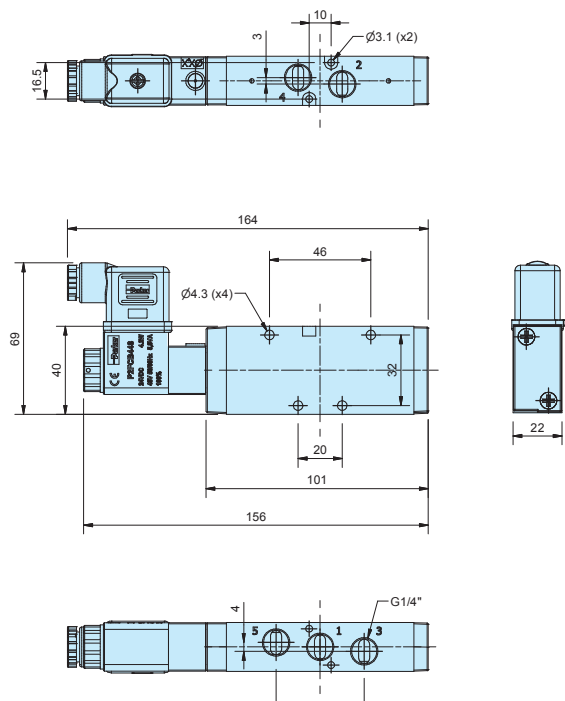

**P2LBZ 5/3**  
Solenoid / Solenoid

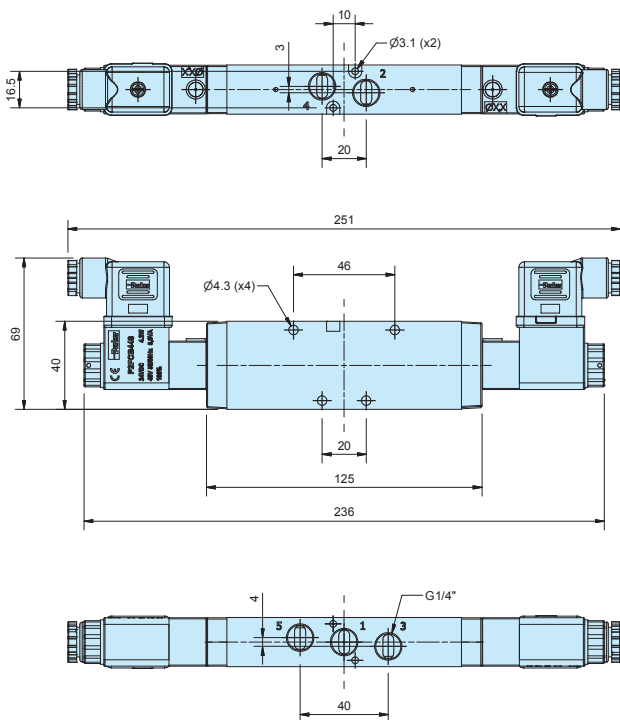

**Solenoid valves**  
Solenoid valves and cable plugs must be ordered separately.  
One pilot valve is required for each E (NDCN only) in the valve order code.

**Directional control valves**

**Dimensions**

**P2LCZ 3/2**  
Air / Air

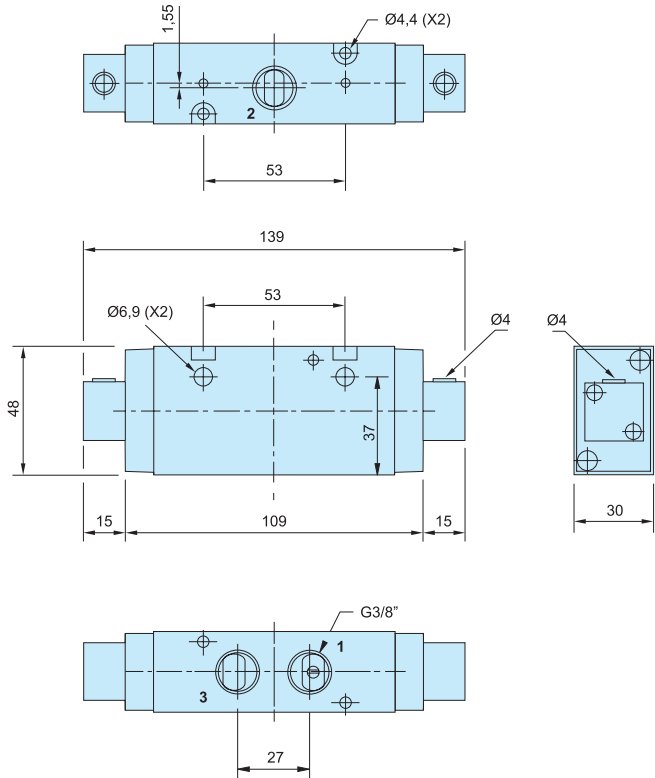

**P2LCZ 3/2**  
Air / Spring

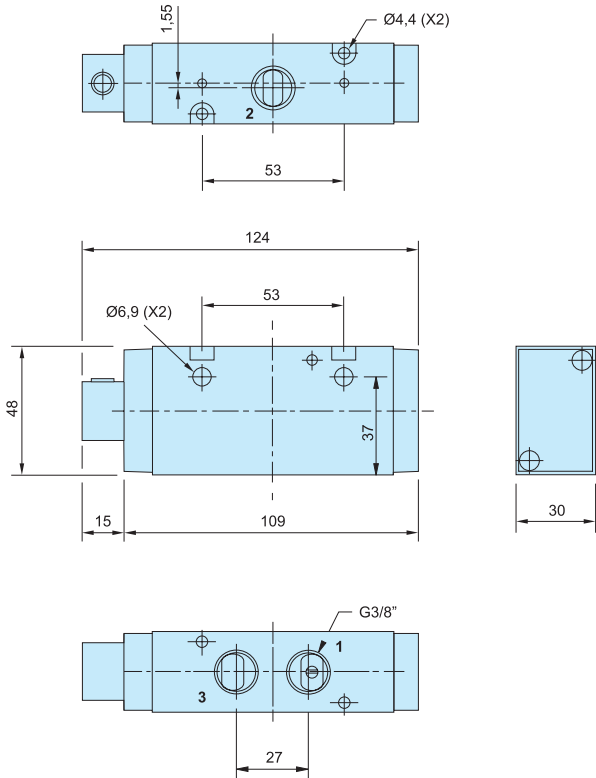

**P2LCZ 3/2**  
Solenoid / Solenoid

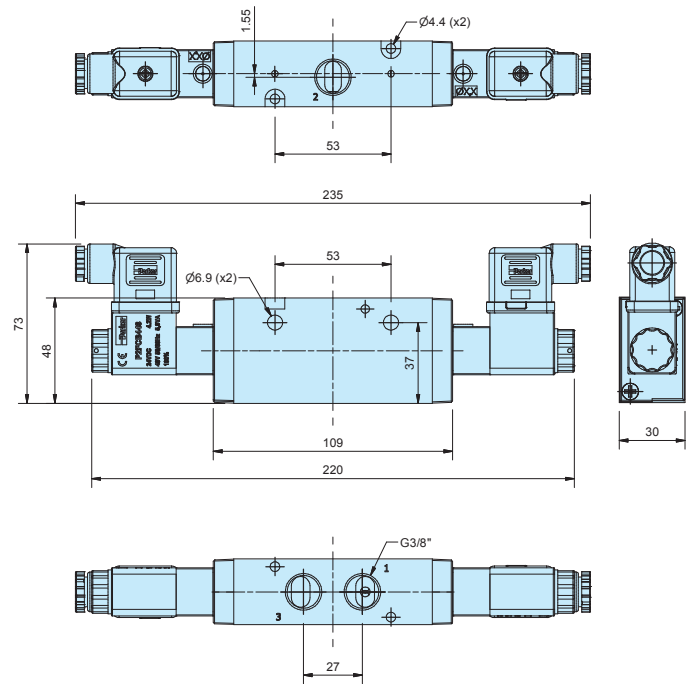

**P2LCZ 3/2**  
Solenoid / Spring

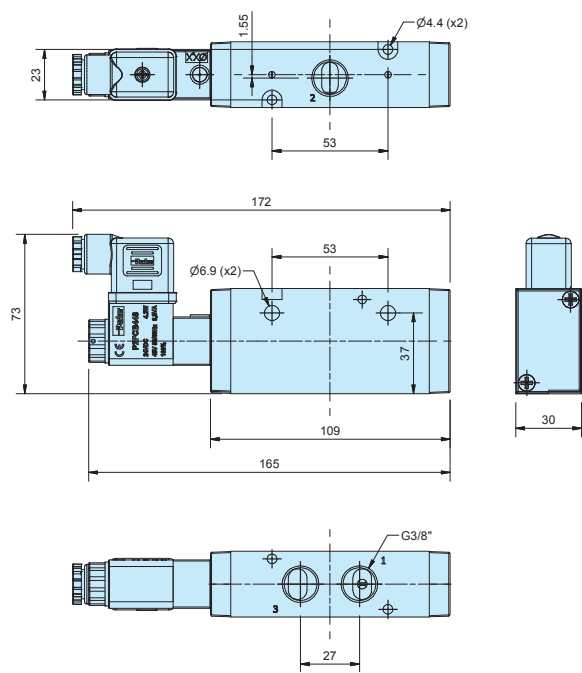

**Directional control valves**

**Dimensions**

**P2LCZ 5/2**  
Solenoid / Solenoid

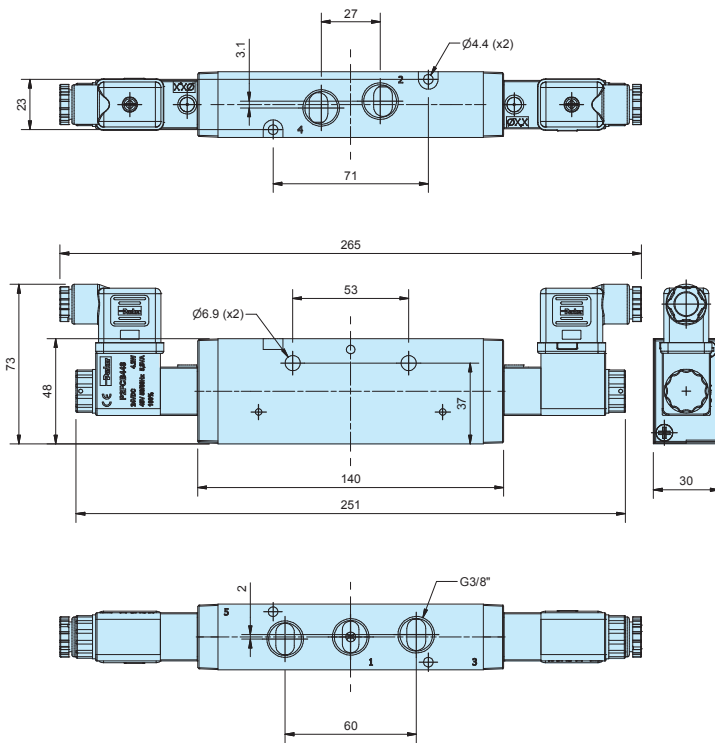

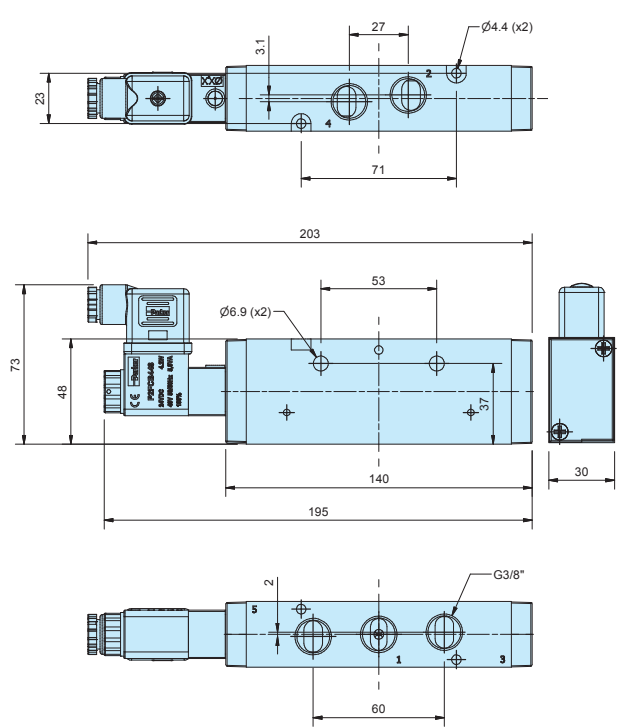

**P2LCZ 5/2**  
Solenoid / Spring

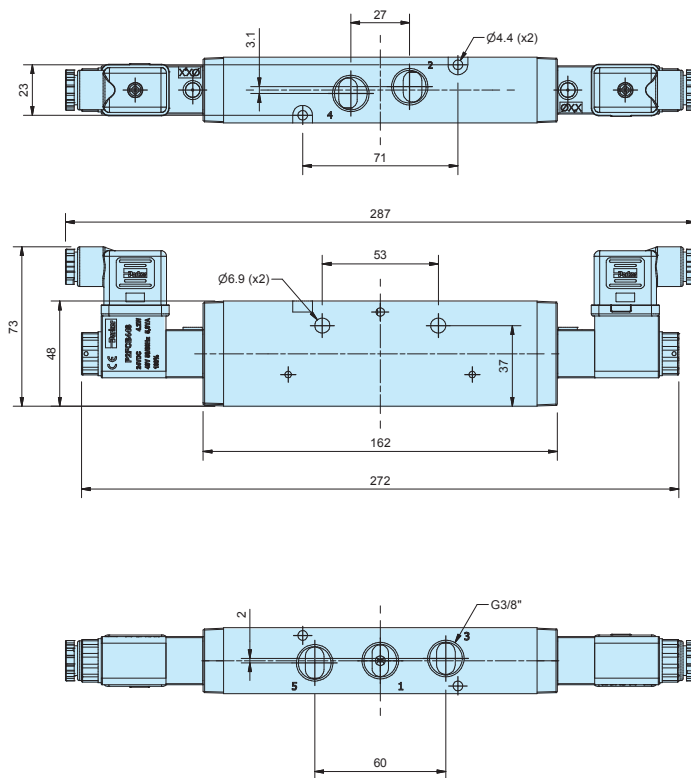

**P2LCZ 5/3**  
Solenoid / Solenoid



Accessories	Type P2LA / P2LB 3/2 valves	Weight kg	Order code
	<b>Manifold bar, P2LB</b> incl. fasteners and O-ring. G3/8 For 2 valves For 4 valves For 6 valves For 8 valves For 10 valves	0.38 0.64 0.89 1.15 1.40	<b>91213202SXZ</b> <b>91213204SXZ</b> <b>91213206SXZ</b> <b>91213208SXZ</b> <b>91213210SXZ</b>
		0.10	<b>912132BPSXZ</b>

**Dimensions**

**Manifold bar**

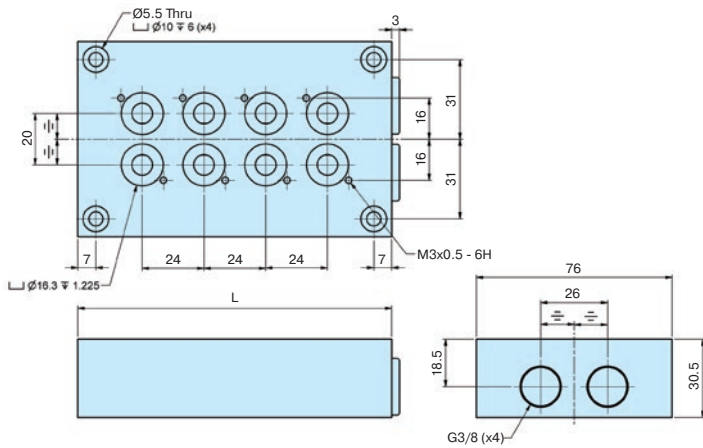





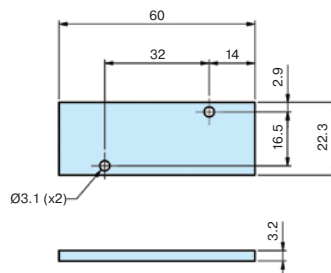

No. of valves	L mm
2	74
4	122
6	170
8	218
10	266

**Blanking plate for manifold bar, P2LB**





Accessories	Type P2LA 5/2 valves	Weight kg	Order code
	<b>Manifold bar, P2LA</b> including seals, mounting screws. G3/8 For 4 valves For 6 valves For 8 valves For 10 valves For 12 valves For 14 valves	0.48 0.63 0.80 0.98 1.10 1.23	9121658075 9121658076 9121658077 9121658078 9121658079 9121658099
	<b>Blanking plate, P2LA</b> for Manifold bar	0.05	9121658063
	<b>Pressure bar, P2LA</b> for common air supply incl. O-rings and mounting screws. G1/4 For 2 valves For 4 valves For 6 valves For 8 valves	0.13 0.20 0.26 0.33	9121658070 9121658071 9121658072 9121658073
	<b>Blanking plate, P2LA</b> for Pressure bar	0.05	9121658074
	<b>Assembly screws, P2LA</b> in stainless steel for valve	0.02	9121658043
	<b>Assembly screws, P2LA</b> in stainless steel for blanking plate	0.01	9121658044
	<b>O-ring kit, P2LA</b> O-rings between valve and manifold bar/Pressure bar	0.01	9121658046

**Dimensions**

**Manifold bar, P2LA**

No. of valves	L mm
4	126
6	174
8	222
10	270
12	318
14	366

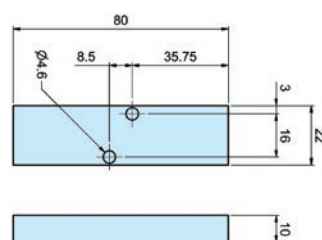
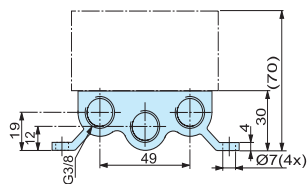
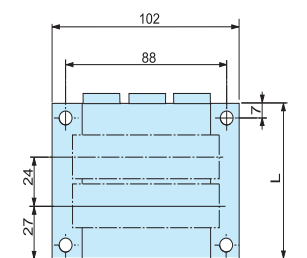

**Blanking plate for manifold bar, P2LA**



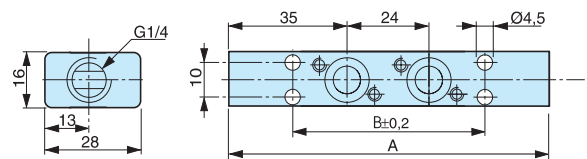

**Pressure bar, P2LA**

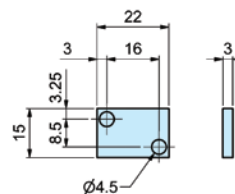

**Blanking plate for pressure bar, P2LA**



No. of valves	A mm	B mm
2	94	56
4	142	104
6	190	152
8	238	200

Accessories	Type P2LB 5/2 valves	Weight kg	Order code
	<b>Manifold bar, P2LB</b> incl. fasteners and O-ring. G3/8 For 2 valves For 4 valves For 6 valves For 8 valves For 10 valves	0.69 1.13 1.56 2.00 2.45	<b>9121594805X</b> <b>9121594806X</b> <b>9121594807X</b> <b>9121594808X</b> <b>9121594812X</b>
	<b>Blanking plate, P2LB</b> for Manifold bar	0.10	<b>9121594809X</b>
	<b>Pressure bar, P2LB</b> for common air supply incl. O-rings and mounting screws. G3/8 For 2 valves For 4 valves For 6 valves For 8 valves For 10 valves	0.38 0.53 0.68 0.83 0.99	<b>9127113301X</b> <b>9127113302X</b> <b>9127113303X</b> <b>9127113304X</b> <b>9127113305X</b>
	<b>Blanking plate P2LB</b> for Pressure bar. G1/4	0.02	<b>9127113306X</b>

**Dimensions**

**Manifold bar, P2LB**

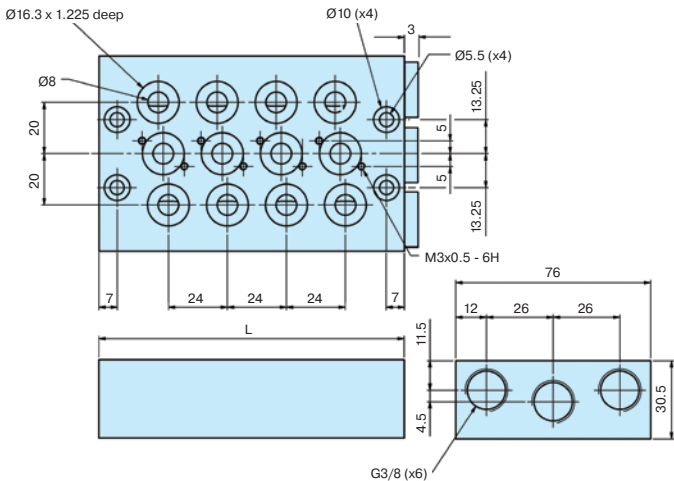

No. of valves	L mm
2	74
4	122
6	170
8	218
10	266

**Blanking plate for manifold bar, P2LB**

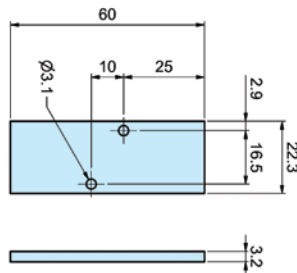

**Pressure bar, P2LB**

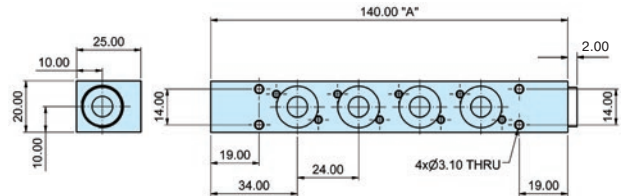

**Blanking plate for pressure bar, P2LB**

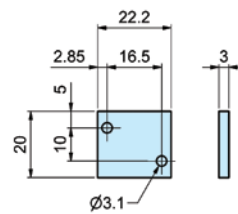

No. of valves	A mm
2	92
4	140
6	188
8	236
10	284

## Directional control valves

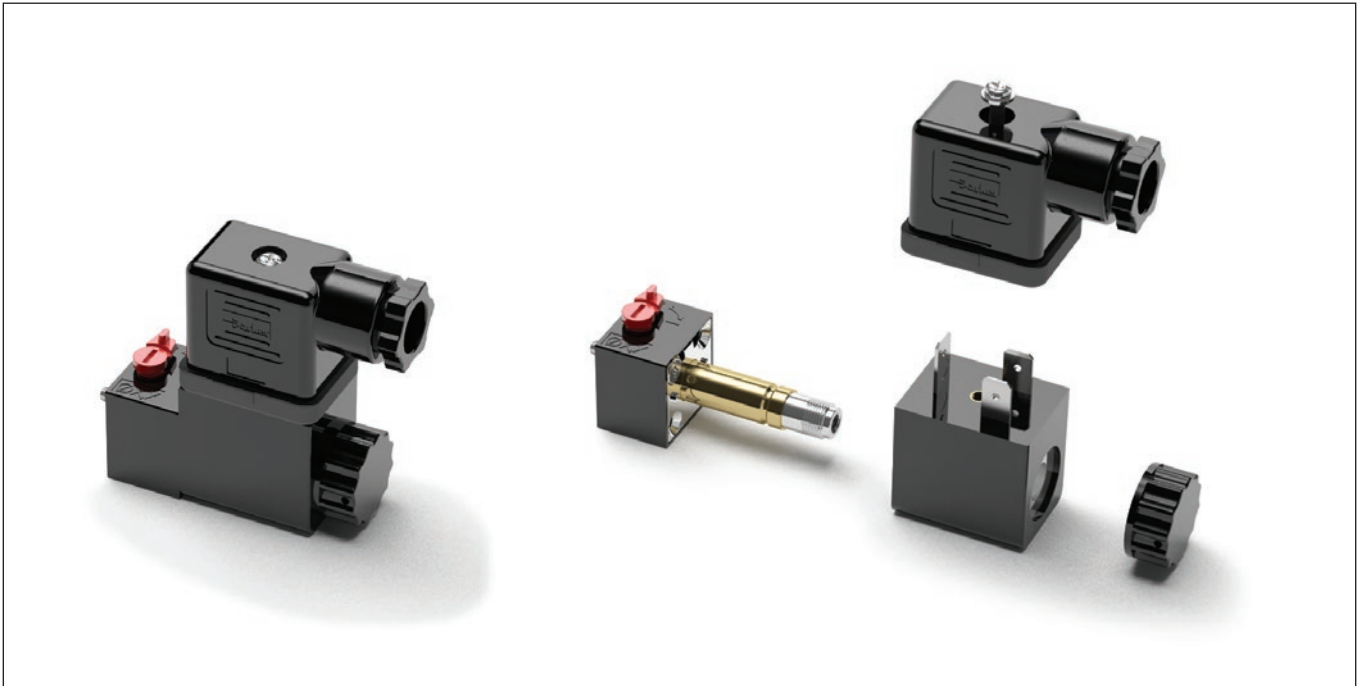

### 22mm Solenoid pilot options

The solenoid pilot operators are designed for piloting pneumatic control valves with compressed air or other inert gases.

The operator is available for normal operating pressures up to 10 bar having an outlet orifice 1.2 mm and exhaust orifice 1.45 mm.

#### Corrosion resistant design

The pilot operator body is manufactured in thermoplastic PA 6 material and the core tube brass is stainless steel. The plunger/core is also made from stainless steel and the valve seats from FKM.

#### Solenoid Pilot Exhaust

These operators all exhaust out of the top of the core tube which is tapped M5. The standard solenoid nut fitted to the core tube is the Diffuser nut which allows the exhaust to escape to atmosphere. This nut also minimises ingress of dirt into the valve through this port. The alternative plastic knurled nut can be specified (refer to part number system) if the exhaust air needs to be captured and piped away using the M5 tapped port.

#### Coils

Coils are wound with enameled copper wire, having temperature index 180°C with class F insulation (155°C) and are encapsulated in Thermoplastic resin. When fitted with suitable connector and correct gasket they give protection to IP65.

#### Manual Override options

The standard manual override is the bi-stable twist lock, extended plastic override. Non locking flush manual override available as option.

**Directional control valves**

**22mm solenoid operator part numbers and spares**

**Solenoid coils for 22mm solenoid operators**

Voltage	Weight (Kg)	Order code Form B
12V 60Hz	0.093	<b>P2FCB340</b>
24V 50/60Hz	0.093	<b>P2FCB342</b>
12V DC	0.093	<b>P2FCB345</b>
24V DC	0.093	<b>P2FCB349</b>
48V DC	0.093	<b>P2FCB351</b>
110V/50Hz, 120V/60Hz	0.093	<b>P2FCB353</b>
230V/50Hz, 230V/60Hz	0.093	<b>P2FCB357</b>

**Spare Solenoid Nuts**

Valves requiring captured exhaust should be fitted with plastic knurled nut

Order code
<b>P2FNP</b>

Valves with vented exhaust are fitted with diffuser plastic nut

Order Code
<b>P2FND</b>

**Solenoid Connectors / Cable Plugs EN175301-803**

	Description	Order code 22mm Industrial Form B
With standard screw	Standard IP65 without flying lead	<b>3EV10V10</b>
	With LED and protection 24V AC/DC	<b>3EV10V20-24</b>
	With LED and protection 110V AC	<b>3EV10V20-110</b>
	With LED and protection 230V AC	<b>3EV10V20-230</b>
With cable	24V AC/DC, 5m cable LED and protection IP65	<b>3EV10V20-24L5</b>
	110V AC/DC, 5m cable LED and protection IP65	<b>3EV10V20-110L5</b>
	230V AC, 5m cable LED and protection IP65	<b>3EV10V20-230L5</b>

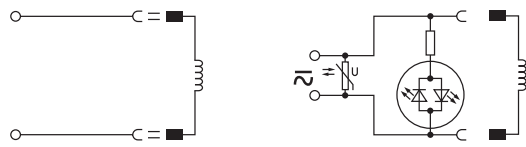

<b>3EV10V10</b>	<b>3EV10V20-24</b>	<b>3EV10V20-24L5</b>
	<b>3EV10V20-110</b>	<b>3EV10V20-110L5</b>
	<b>3EV10V20-230</b>	<b>3EV10V20-230L5</b>

**Cable Plug Dimensions (mm)**

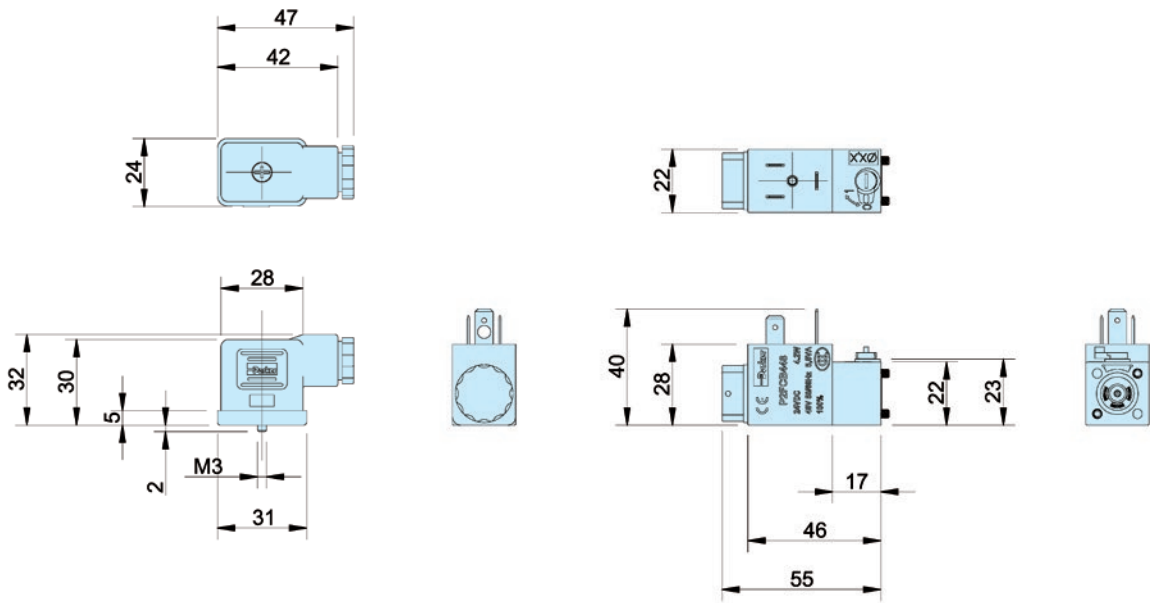

**Directional control valves**

---



**Directional control valves**

---

# Parker Worldwide

## Europe, Middle East, Africa

### AE – United Arab Emirates,

Dubai  
Tel: +971 4 8127100

### AT – Austria, St. Florian

Tel: +43 (0)7224 66201

### BE/NL/LU – Benelux,

Hendrik Ido Ambacht  
Tel: +31 (0)541 585 000

### BY – Belarus, Minsk

Tel: +48 (0)22 573 24 00

### CH – Switzerland, Etoy

Tel: +41 (0)21 821 87 00

### CZ – Czech Republic,

Prague  
Tel: +420 284 083 111

### DE – Germany, Kaarst

Tel: +49 (0)2131 4016 0

### DK – Denmark, Ballerup

Tel: +45 43 56 04 00

### ES – Spain, Madrid

Tel: +34 902 330 001

### FI – Finland, Vantaa

Tel: +358 (0)20 753 2500

### FR – France, Contamine s/Arve

Tel: +33 (0)4 50 25 80 25

### HU – Hungary, Budaörs

Tel: +36 23 885 470

### IE – Ireland, Dublin

Tel: +353 (0)1 466 6370

### IL – Israel

Tel: +39 02 45 19 21

### IT – Italy, Corsico (MI)

Tel: +39 02 45 19 21

### NO – Norway, Asker

Tel: +47 66 75 34 00

### PL – Poland, Warsaw

Tel: +48 (0)22 573 24 00

### PT – Portugal

Tel: +351 22 999 7360

### RO – Romania, Bucharest

Tel: +40 21 252 1382

### RU – Russia, Moscow

Tel: +7 495 645-2156

### SE – Sweden, Borås

Tel: +46 (0)8 59 79 50 00

### SL – Slovenia, Novo Mesto

Tel: +386 7 337 6650

### TR – Turkey, Istanbul

Tel: +90 216 4997081

### UK – United Kingdom, Warwick

Tel: +44 (0)1926 317 878

### ZA – South Africa, Kempton

Park  
Tel: +27 (0)11 961 0700

## North America

### CA – Canada, Milton, Ontario

Tel: +1 905 693 3000

### US – USA, Cleveland

Tel: +1 216 896 3000

## Asia Pacific

### AU – Australia, Castle Hill

Tel: +61 (0)2-9634 7777

### CN – China, Shanghai

Tel: +86 21 2899 5000

### HK – Hong Kong

Tel: +852 2428 8008

### IN – India, Mumbai

Tel: +91 22 6513 7081-85

### JP – Japan, Tokyo

Tel: +81 (0)3 6408 3901

### KR – South Korea, Seoul

Tel: +82 2 559 0400

### MY – Malaysia, Shah Alam

Tel: +60 3 7849 0800

### NZ – New Zealand, Mt

Wellington

Tel: +64 9 574 1744

### SG – Singapore

Tel: +65 6887 6300

### TH – Thailand, Bangkok

Tel: +662 186 7000

### TW – Taiwan, Taipei

Tel: +886 2 2298 8987

## South America

### AR – Argentina, Buenos Aires

Tel: +54 3327 44 4129

### BR – Brazil, Sao Jose dos

Campos

Tel: +55 080 0727 5374

### CL – Chile, Santiago

Tel: +56 22 303 9640

### MX – Mexico, Toluca

Tel: +52 72 2275 4200

### EMEA Product Information Centre

Free phone: 00 800 27 27 5374

(from AT, BE, CH, CZ, DE, DK, EE, ES, FI, FR, IE, IL,  
IS, IT, LU, MT, NL, NO, PL, PT, RU, SE, SK, UK, ZA)

### US Product Information Centre

Toll-free number: 1-800-27 27 537

[www.parker.com](http://www.parker.com)

