



Air Motors

P1VAS Series Stainless Steel
0,12 to 1,6 kW

Catalogue PDE2554TCUK



ENGINEERING YOUR SUCCESS.

P1VAS - Stainless Steel Air Motors

Features	Air motor	Hydraulic motor	Electric motor
Overload safe	***	***	*
Increased torque at higher loads	***	**	*
Easy to limit torque	***	***	*
Easy to vary speed	***	***	*
Easy to limit power	***	***	*
Reliability	***	***	***
Robustness	***	***	*
Installation cost	***	*	**
Ease of service	***	**	*
Safety in damp environments	***	***	*
Safety in explosive atmospheres	***	***	*
Safety risk with electrical installations	***	***	*
Risk of oil leak	***	*	***
Hydraulic system required	***	*	***
Weight	**	***	*
Power density	**	***	*
High torque for size	**	***	*
Noise level during operation	*	***	**
Total energy consumption	*	**	***
Service interval	*	**	***
Compressor capacity required	*	***	***
Purchase price	*	*	***

* = good, ** = average, *** = excellent



Important

Before carrying out service activities, make sure the air motor is vented. Before disassembling the motor, disconnect the primary air hose to ensure that the air supply is interrupted.



Note

All technical data in the catalogue are typical values. The air quality is a major factor in the service life of the motor, see ISO 8573-1.



WARNING

FAILURE OR IMPROPER SELECTION OR IMPROPER USE OF THE PRODUCTS AND/OR SYSTEMS DESCRIBED HEREIN OR RELATED ITEMS CAN CAUSE DEATH, PERSONAL INJURY AND PROPERTY DAMAGE.

This document and other information from Parker Hannifin Corporation, its subsidiaries and authorized distributors provide product and/or system options for further investigation by users having technical expertise. It is important that you analyze all aspects of your application and review the information concerning the product or system in the current product catalog. Due to the variety of operating conditions and applications for these products or systems, the user, through its own analysis and testing, is solely responsible for making the final selection of the products and systems and assuring that all performance, safety and warning requirements of the application are met. The products described herein, including without limitation, product features, specifications, designs, availability and pricing, are subject to change by Parker Hannifin Corporation and its subsidiaries at any time without notice.

SALE CONDITIONS

The items described in this document are available for sale by Parker Hannifin Corporation, its subsidiaries or its authorized distributors. Any sale contract entered into by Parker will be governed by the provisions stated in Parker's standard terms and conditions of sale (copy available upon request).

Contents	Page
General	
The steps to size	4
Principles of Air Motors	5
Introduction	6 - 9
Air quality & lubrication	10 - 11
Air Motor features	12
P1VAS Air Motors series	13
Technical data	14
Material and technical specification	14
Choices of vanes	15
ATEX classes	15
Optimum working speed and torque range	15
Permitted shaft loadings	16
Stainless Steel Air Motors 120 to 1600 watts	
Reversible air motor 120 watts	18
Dimensions	19
Reversible air motor 200 and 300 watts	20
Dimensions	21
Reversible air motor 600, 900 & 1600 watts	22
Dimensions 600 watts	23
Dimensions 900 watts	24
Dimensions 1600 watts	25
Lubrication and service life	26
Service kits	27
Order key code	28

Choosing the correct air motor for your application**① Which drive principle of the air motor is suitable for your application?**

- Air vane motor are suitable for regular operating cycles, speed is very small e.g. 16 rpm
- Tooth gear air motor or turbines are more suitable for continuous operation, 24 hours non-stop, speed is in a upper range, up to 140,000 rpm
- Oil free operation is often an option for these three principles of air motors.

② Which motor materials are suitable for your application?

- Will the air motor work in a normal production area
- Or in a paper industry
- Or in the food processing industry, in contact or not with food
- Or in underwater usage
- Or in the medical, pharmaceutical industries
- Or in potentially explosive areas
- Others, please describe your environment

③ How do you calculate the motor power taking the application conditions into consideration?

1. Which rotational direction? Clockwise, anti-clockwise, reversible?
2. Air pressure working range? Which air class quality is available?
3. Which torque and which speed under load do you expect to obtain?
4. Calculate the basic power with the formula

$$P = M \times n / 9550 \text{ with } P \text{ power output in kW, } M \text{ nominal torque in Nm, } n \text{ nominal speed in rpm}$$

5. Check performance data of air motors in our catalogues. Note that all data is at 6 bar in the inlet of the air motor, max 3 meters for tubes and oil lubricated operations.
6. To adapt the difference of air pressure with your operation conditions, please check graphs in our catalogues and how to do it.
7. or you can adapt the need of air to fit your operation conditions by throttling the outlet flow in the air motor you will reduce speed without loss of torque.
8. Check if you need an oil free or not working operation. 1 to 2 drops of oil per cube meter are needed to optimize performance and life time of air motors. Oil free operation will decrease by 10 to 15% the performance of air motors.

④ How do you integrate your air motor in your system?

- In which position is the air motor used?
- Do you need to use a brake?
- Do you want to use your own gear box and put it somewhere else in the machine?
- Do you need extra components like fittings, tubes, valves and FRLs?

⑤ How do you ensure a long life and high performance of the air motor?

- Ensure you air quality is in accordance with our specifications, oil or oil free lubrication operations.
- Keep the recommended maintenance intervals

⑥ How do you determine the purchasing and running costs after the air motor installation?

- Keep same level of your air quality.

Principles of motor functioning

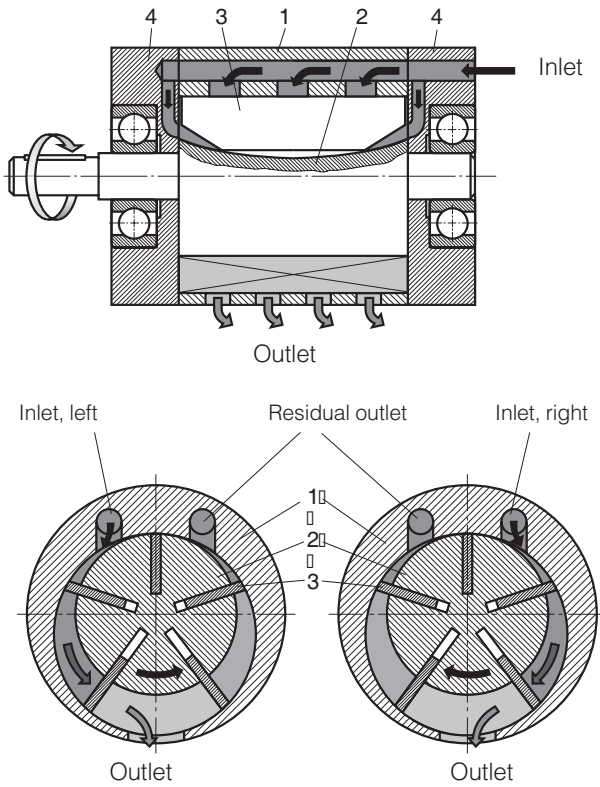

- 1 Rotor cylinder
- 2 Rotor
- 3 Vanes
- 4 End piece with bearing

There are a number of air motor designs, Parker has chosen the vane rotor design due to its simplicity and reliable operation. Plus the small external dimensions of vane motors make them suitable for all applications.

The principle of the vane motor is that a rotor with a number of vanes is enclosed in a rotor cylinder. Compressed air is supplied through one connection and air escapes from the other.

For reliable starting, the springs press the vanes against the rotor cylinder and the air pressure always bears at right angles against a surface. This means that the resulting torque of the motor is due to the vane surfaces and the air pressure.

Torque, power and air consumption Graphs

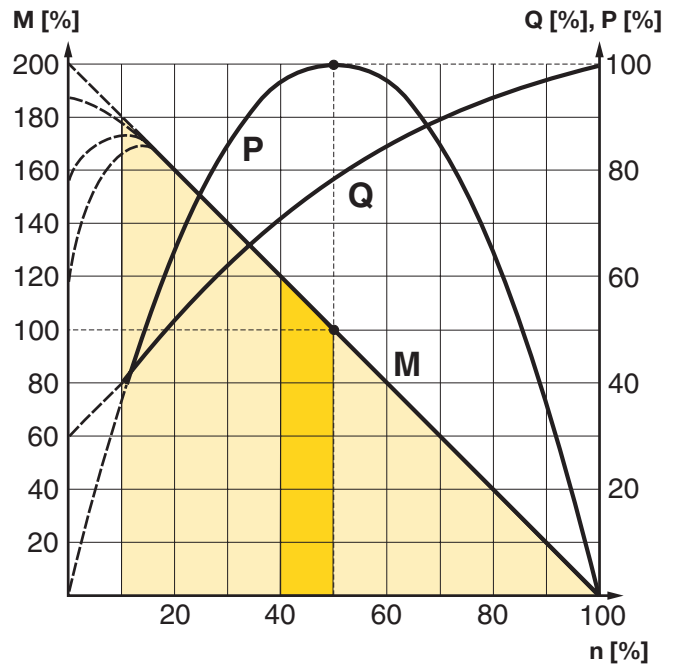

The curve is for 6 bar
P = power **Q = air consumption**
M = torque **n = speed**

- Possible working range of motor.**
- Optimum working range of motor.**
 Higher speeds = more vane wear
 Lower speeds with high torque = more gearbox wear

The performance characteristics of each motor are shown in a family of curves as above, from which torque, power and air consumption can be read off as a function of speed. Power is zero when the motor is stationary and also when running at free speed (100%) with no load. Maximum power (100%) is normally developed when the motor is driving a load at approximately half the free speed (50%).

Torque at free speed is zero, but increases as soon as a load is applied, rising linearly until the motor stalls. As the motor can then stop with the vanes in various positions, it is not possible to specify an exact torque. However, a minimum starting torque is shown in all tables.

Air consumption is greatest at free speed, and decreases with decreasing speed, as shown in the above diagram.

Performance

The performance of an air motor is dependent on the inlet pressure. At a constant inlet pressure, air motors exhibit the characteristic linear output torque / speed relationship. However, by simply regulating the air supply, using the techniques of throttling or pressure regulation, the output of an air motor can easily be modified. The most economical operation of an air motor (least wear, least air consumption, etc.) is reached by running close to nominal speed. By torque of $M = 0$, the maximum speed (idle speed) is reached. Shortly before standstill ($n = 0$), the air motor reaches its maximum torque ($M_{max} = 2 \times M_0$). At nominal speed (n_n), for example in the middle of the speed range, air motor reaches its maximum power output (P_{max}).

Energy Efficiency

A pneumatic motor achieves its maximum power when it is operating as close as possible to its rated speed (50% of the rated idle speed). The energy balance is best in this area, because the compressed air is used efficiently.

Air pressure correction factors

To adapt the difference of air pressure with your operation conditions

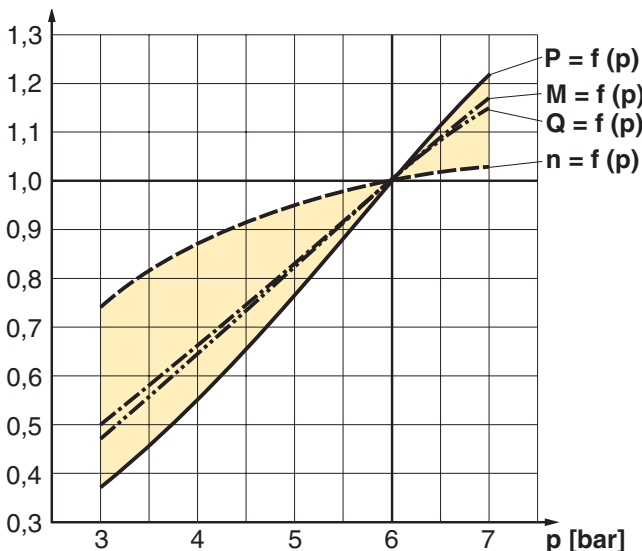

P = Power, M = Torque, Q = Air consumption, N = Speed

Pressure [p] bar / PSI	Power [P] %	Speed [n] %	Troque [M] %	Air Consump. [Q] %
7 / 99	121	103	117	117
6 / 85	100	100	100	100
5 / 71	77	95	83	83
4 / 57	55	87	67	67
3 / 42	37	74	50	50

All catalogue data and curves are specified at a supply pressure of 6 bar to the motor. This diagram shows the effect of pressure on speed, specified torque, power and air consumption.

Start off on the curve at the pressure used and then look up to the lines for power, torque and air consumption. Read off the correction factor on the Y axis for each curve and multiply this by the specified catalogue data in the table, or data read from the torque and power graphs.

Example: at 4 bar supply pressure, the power is only 0.55 x power at 6 bar supply pressure. This example shows how strongly power falls if supply pressure is reduced. You must therefore ensure that the motor is supplied through pipes of sufficient diameter to avoid pressure drop.

The speed and torque can also be regulated by installing a pressure regulator in the inlet pipe. This means that the motor is constantly supplied with air at lower pressure, which means that when the motor is braked, it develops a lower torque on the output shaft.

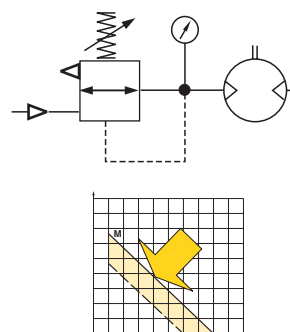

Pressure regulation at motor inlet.

Theoretically torque curve change caused by pressure change

Speed regulation, air flow reduction

Every size reduction or restriction on the air line, whether of the supply hose itself or fittings, before the air motor affects the amount of the supplied air. By throttling you reduce the speed of your motor and simultaneously, the required torque. That means that you reduce the motor performance. The most common way to reduce the speed of a motor is to install a flow control valve in the air outlet, you can set the speed without loss of the torque. When the motor is used in applications where it must reverse and it is necessary to restrict the speed in both directions, flow control valves with by-pass should be used in both directions. If the inlet air is restricted, the air supply is restricted and the free speed of the motor falls, but there is full pressure on the vanes at low speeds. This means that we get full torque from the motor at low speeds despite the low air flow. Since the torque curve becomes "steeper", this also means that we get a lower torque at any given speed than would be developed at full air flow. The benefit of throttling the inlet is that air consumption is reduced, whereas throttling the exhaust air maintains a slightly higher starting torque.

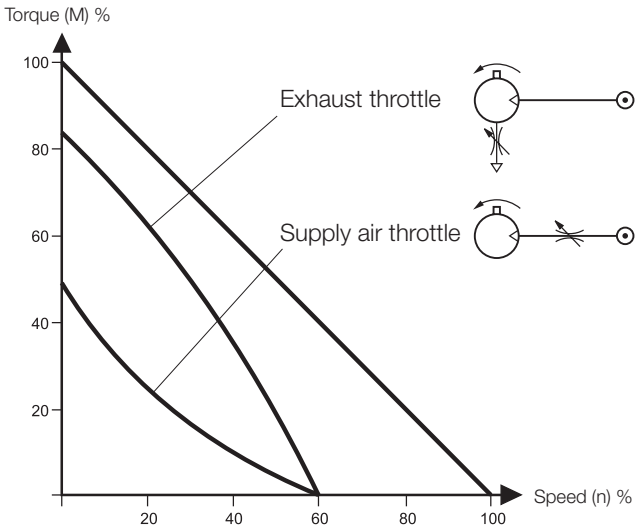

Throttling

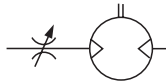

Supply or exhaust throttling, non-reversible motor

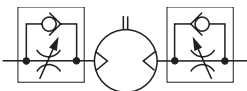

Supply throttling, reversible motor

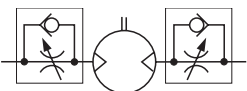

Exhaust throttling, reversible motor

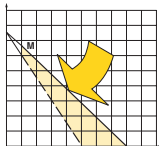

Theoretically torque curve change caused by throttling

Component choice for air supply

Direction of motor rotation

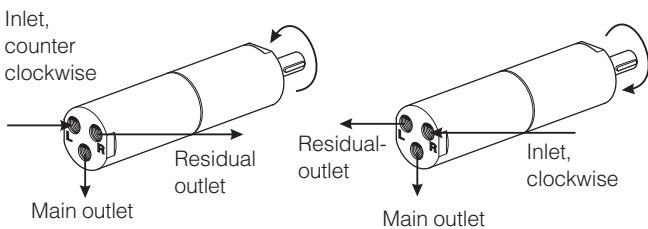

The direction of rotation of reversible motors is controlled by supplying inlet L or inlet R with compressed air. Air motors can be stopped and started continually without damage.

As the motor begins to rotate air is trapped between the vanes and is compressed. This air is exhausted through the exhaust port. As the rotor continues its rotation, trapped air is compressed and exhausted through the residual port. If this air is not exhausted, the motor will be braked and maximum power will not be obtained.

Compressed air quality

Oil and oil mist are avoided whenever possible to ensure a clean work environment. In addition, purchasing, installation and maintenance of oil equipment can be expensive. All users in all industries now try to avoid using components which have to be lubricated. The P1V air motors series are equipped with vanes for intermittent lubrication free operation as standard, which is the most common application of air motors.

Dry unlubricated compressed air



If unlubricated compressed air is used, the compressed air should comply with the purity standards below in order to guarantee the longest possible overall service life. If the unlubricated compressed air has a high water content, condensation forms inside the motor, causing corrosion in all internal components. A ball bearing can be destroyed in a remarkably short time if it comes into contact with a single water droplet. For indoor use, we recommend ISO8573-1 purity class 3.4.1. To achieve this, compressors must be fitted with after coolers, oil filters, refrigerant air dryers and air filters. For indoor/outdoor use, we recommend ISO8573-1 purity class 1.2.1.

To achieve this, compressors must be fitted with after coolers, oil filters, adsorption dryers and dust filters.

Oil mist



If oil mist is used (approx. 1 drop of oil per m3 of compressed air), the oil not only acts as a lubricant but also protects against corrosion. This means that compressed air with a certain water content may be used without causing corrosion problems inside the motor. ISO8573-1 purity class 3.-.5 may be used without difficulty. The following oils are recommended for use in the food stuffs industry: Shell Cassida Fluid HF 32 or Klüberoil 4 UH 1-32

ISO 8573-1 purity classes

Quality class	Contaminants		Water	Oil
	particle size (µm)	max. concentration (mg/m³)	max. pressure dew point (°C)	max. concentration (mg.m³)
1	0.1	0.1	-70	0.01
2	1	1	-40	0.1
3	5	5	-20	1.0
4	15	8	+3	5.0
5	40	10	+7	25
6	-	-	+10	-

For example: compressed air to purity class 3.4.3. This means a 5 µm filter (standard filter), dew point +3°C (refrigerant cooled) and an oil concentration of 1,0 mg oil/m3 (as supplied by a standard compressor with a standard filter).

Air supply

Since the supply pressure at the air motor inlet port is of considerable importance for obtaining the power, speed and torque quoted in the catalogue, the recommendations below should be observed.

The following data must be complied with:

- Supply pressure: 7 bar
- Regulator pressure setting: 6.7 bar
- Pipe length between air treatment unit and valve: max. 1 m
- Pipe length valve and air motor: max 2 m

The pressure drop through the air preparation unit, pipe, valve means that 6 bar pressure is obtained at the motor supply port. Please refer to the correction diagram and factors to see what lower supply pressure means for power, speed and torque.

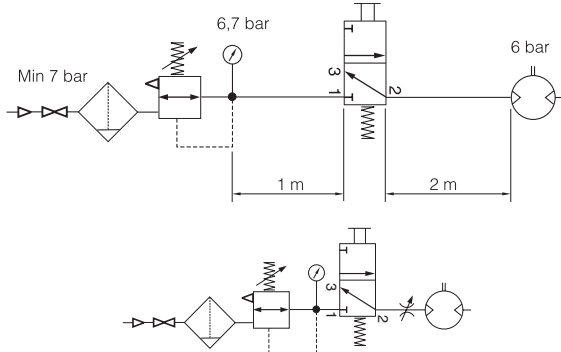

Shut-off, filtering, pressure regulation and control valve

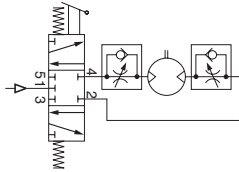

Reversible motor with 5/3 control valve

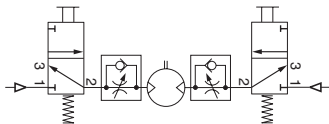

Reversible motor with two 3/2 control valves

The air with which the motor is supplied must be filtered and regulated. Directional valves are needed to provide it with air, to get the motor to rotate when we want it to. These valves can be equipped with several means of actuation, such as electric, manual and pneumatic control. When the motor is used in a non-reversible application, it is sufficient to use a 2/2 or 3/2 valve function for supply. Either one 5/3 or two 3/2 valves functions are needed for a reversible motor, to ensure that the motor receives compressed air and the residual air outlet is vented. A flow control valve can be installed in the supply pipe to regulate the motor speed if the motor is not used as a reversible motor.

One flow control valve with by-pass is needed to regulate each direction of rotation if the motor is used as a reversible motor. The built-in check valve will then allow air from the residual air outlet to escape through the outlet port in the control valve. The compressed air supply must have sufficiently large pipes and valves to give the motor the maximum power. The motor needs 6 bar at the supply port all the time. For example, a reduction of pressure to 5 bar reduces the power developed to 77% and to 55% at 4 bar!

Silencing

Exhaust silencer

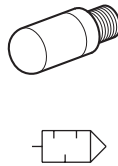

Central silencer

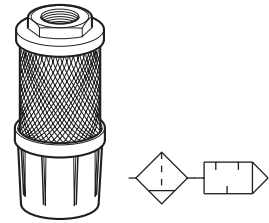

The noise from an air motor consists of both mechanical noise and a pulsating noise from the air flowing out of the outlet. The installation of the motor has a considerable effect on mechanical noise. It should be installed so that no mechanical resonance effects can occur. The outlet air creates a noise level which can amount to 115 dB(A) if the air is allowed to exhaust freely into the atmosphere. Various types of exhaust silencers are used to reduce this level. The most common type screws directly onto the exhaust port of the motor. Since the motor function causes the exhaust air to pulsate, it is a good idea to allow the air to exhaust into some kind of chamber first, which reduces the pulsations before they reach the silencer. The best silencing method is to connect a soft plastic hose to a large central silencer with the largest possible area, to reduce the speed of the out-flowing air as far as possible.

NOTE! Remember that if a silencer which is too small or is blocked, generates back pressure on the outlet side of the motor, which reduces the motor power.

CE marking

The air motors are supplied as “Components for installation” – the installer is responsible for ensuring that the motors are installed safely in the overall system. Parker Pneumatic guarantees that its products are safe, and as a supplier of pneumatic equipment we ensure that the equipment is designed and manufactured in accordance with the applicable EU directive.

Most of our products are classed as components as defined by various directives, and although we guarantee that the components satisfy the fundamental safety requirements of the directives to the extent that they are our responsibility, they do not usually carry the CE mark. Nevertheless, most P1VAS motors carry the CE mark because they are ATEX certified (for use in explosive atmospheres).

The following are the currently applicable directives:

- Machinery Directive(essential health and safety requirements relating to the design and structure of machines and safety components)
- EMC Directive
- Simple Pressure Vessels Directive
- Low Voltage Directive
- ATEX Directive (ATEX = ATmosphere EXplosive)

Torque, power and air consumption graphs

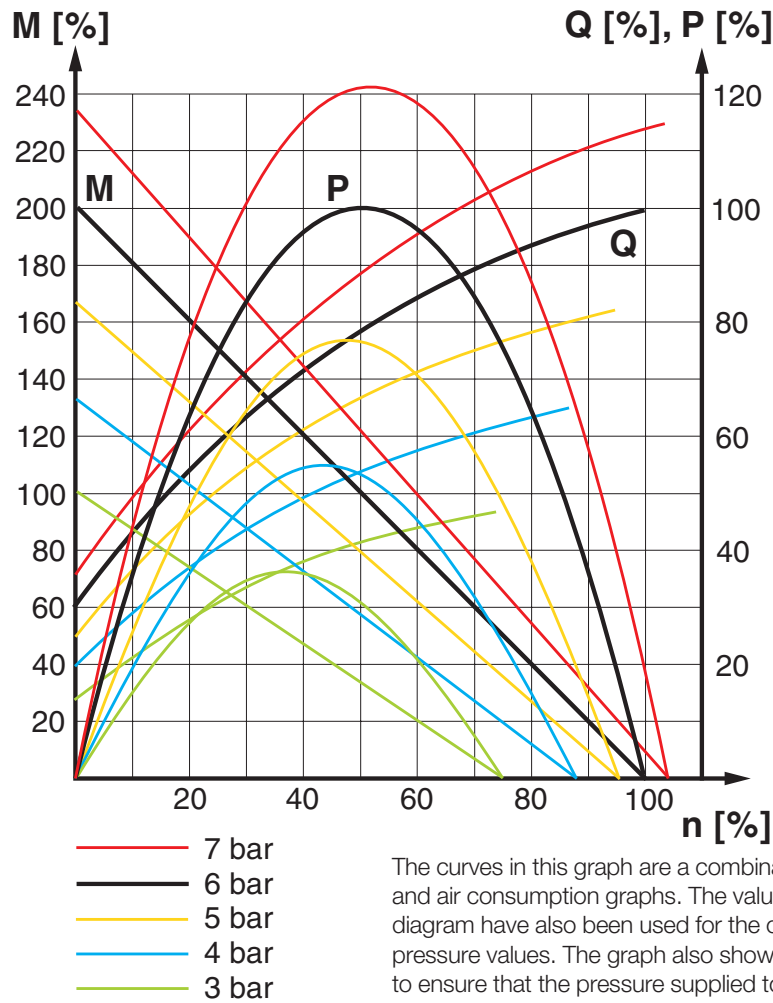

P = power **Q = air consumption**
M = torque **n = speed**

The curves in this graph are a combination of the torque, power and air consumption graphs. The values from the correction diagram have also been used for the curves for the different pressure values. The graph also shows that it is very important to ensure that the pressure supplied to the inlet port of the motor is correct, in order to allow the motor to work at maximum capacity. If the valve supplying a large motor is too small or if the supply line is underspecified, the pressure at the inlet port may be so low that the motor is unable to do its work. One solution would be to upgrade the valve and supply system, or alternatively you could replace the motor with a smaller motor with lower air consumption. The result would be increased pressure at the inlet port, which means that the smaller motor could carry out the necessary work. However, you may need to select a smaller motor with a lower free speed in order to obtain sufficient torque at the outgoing shaft.

Choice of an air motor, general

The motor to be used should be selected by starting with the torque needed at a specific spindle speed. In other words, to choose the right motor, you have to know the required speed and torque. Since maximum power is reached at half the motor's free speed, the motor should be chosen so that the point aimed at is as close as possible to the maximum power of the motor.

The design principle of the motor means that higher torque is generated when it is braked, which tends to increase the speed. This means that

the motor has a kind of speed selfregulation function built in. Use the following graph to choose the correct motor size and the correct type of gear as appropriate. The graph contains the points for the maximum torque of each motor at maximum power. Put in your point on the graph and select a marked point above and to the right of the point you need.

Then check the characteristic graph of each motor to find more accurate technical data. Always select a motor where the data required is in the orange field. Also use the correction diagram to see what it would mean to use different air supply pressures or different air flow in the motor.

Tip: Select a motor which is slightly too fast and powerful, regulate its speed and torque with a pressure regulator and/or restriction to achieve the optimum working point.

Do you need any support to select the right air motor, please feel free to consult your local sales office.

Specifying air quality (purity) in accordance with ISO8573-1:2010, the international standard for compressed air quality

ISO8573-1 is the primary document used from the ISO8573 series as it is this document which specifies the amount of contamination allowed in each cubic metre of compressed air.

ISO8573-1 lists the main contaminants as Solid Particulate, Water and Oil. The purity levels for each contaminant are shown separately in tabular form, however for ease of use, this document combines all three contaminants into one easy to use table.

ISO8573-1:2010 CLASS	Solid Particulate			Mass Concentration mg/m ³	Water		Oil
	Maximum number of particles per m ³				Vapour Pressure Dewpoint	Liquid g/m ³	Total Oil (aerosol liquid and vapour)
	0,1 - 0,5 micron	0,5 - 1 micron	1 - 5 micron				mg/m ³
0	As specified by the equipment user or supplier and more stringent than Class 1						
1	≤ 20 000	≤ 400	≤ 10	-	≤ -70 °C	-	0,01
2	≤ 400 000	≤ 6 000	≤ 100	-	≤ -40 °C	-	0,1
3	-	≤ 90 000	≤ 1 000	-	≤ -20 °C	-	1
4	-	-	≤ 10 000	-	≤ +3 °C	-	5
5	-	-	≤ 100 000	-	≤ +7 °C	-	-
6	-	-	-	≤ 5	≤ +10 °C	-	-
7	-	-	-	5 - 10	-	≤ 0,5	-
8	-	-	-	-	-	0,5 - 5	-
9	-	-	-	-	-	5 - 10	-
X	-	-	-	> 10	-	> 10	> 10

Specifying air purity in accordance with ISO8573-1:2010

When specifying the purity of air required, the standard must always be referenced, followed by the purity class selected for each contaminant (a different purity class can be selected for each contamination if required).

An example of how to write an air quality specification is shown below:

ISO 8573-1:2010 Class 1.2.1

ISO 8573-1:2010 refers to the standard document and its revision, the three digits refer to the purity classifications selected for solid particulate, water and total oil. Selecting an air purity class of 1.2.1 would specify the following air quality when operating at the standard's reference conditions:

Class 1 - Particulate

In each cubic metre of compressed air, the particulate count should not exceed 20,000 particles in the 0.1 - 0.5 micron size range, 400 particles in the 0.5 - 1 micron size range and 10 particles in the 1 - 5 micron size range.

Class 2 - Water

A pressure dewpoint (PDP) of -40°C or better is required and no liquid water is allowed.

Class 1 - Oil

In each cubic metre of compressed air, not more than 0.01mg of oil is allowed. This is a total level for liquid oil, oil aerosol and oil vapour.

ISO8573-1:2010 Class zero

- **Class 0 does not mean zero contamination.**
- **Class 0 requires the user and the equipment manufacturer to agree contamination levels as part of a written specification.**
- **The agreed contamination levels for a Class 0 specification should be within the measurement capabilities of the test equipment and test methods shown in ISO8573 Pt 2 to Pt 9.**
- **The agreed Class 0 specification must be written on all documentation to be in accordance with the standard.**
- **Stating Class 0 without the agreed specification is meaningless and not in accordance with the standard.**
- **A number of compressor manufacturers claim that the delivered air from their oil-free compressors is in compliance with Class 0.**
- **If the compressor was tested in clean room conditions, the contamination detected at the outlet will be minimal. Should the same compressor now be installed in typical urban environment, the level of contamination will be dependent upon what is drawn into the compressor intake, rendering the Class 0 claim invalid.**
- **A compressor delivering air to Class 0 will still require purification equipment in both the compressor room and at the point of use for the Class 0 purity to be maintained at the application.**
- **Air for critical applications such as breathing, medical, food, etc typically only requires air quality to Class 2.2.1 or Class 2.1.1.**
- **Purification of air to meet a Class 0 specification is only cost effective if carried out at the point of use.**

Maximise Your Air Motor Application with the P3X Lite

The P3X Lite air preparation system is constructed from ultra light weight technopolymers instead of the traditional aluminium or zinc die cast, making it 45% lighter than conventional units.

This non-metal construction also means that the P3X Lite is corrosion free enabling it to be used in harsh industrial environments where anti freeze or aggressive synthetic oils are present.

The use of technopolymers in the design of P3X Lite has facilitated a universal body design, this has resulted in reducing the number of variants required to cover the full spectrum of applications. This can dramatically lower logistic costs and simplify stock holding for customers making the P3X Lite a very cost effective solution.



Nano Mist

Nano Mist Technology Self-Adjusting Lubricator

With conventional lubricators, only the oil volume per time unit can be adjusted. If the demand changes, the quantity move to be on one line, not split in two still remains constant.

The P3X Lite lubricator concept sets new benchmarks here. For the first time, the oil volume is automatically adjusted to the flow rate. This ensures that there is neither too little nor too much oil in the system, which leads to clear economic and ecological advantages.

In addition, with conventional systems, the distance between the lubricator and the equipment has to be less than 8 meters. With larger distances, the dispensed oil is deposited as a wall flow.

The new lubricator principle of the P3X Lite allows for distances of up to 40 meters. This opens up new scope for the design of even more efficient production systems.



P1VAS - Stainless Steel Air Motors

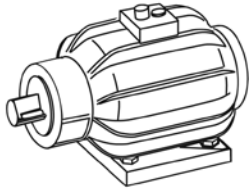

Air motors have much smaller installation dimensions than corresponding electric motors.



Air motors can be loaded until they stall, without damage. They are designed to be able to withstand the toughest heat, vibration, impact etc.



The shape, design and non-lubricated operation allow the motor to be suitable for use in the food industry.



Air motors can be stopped and started continually without damage.



The weight of an air motor is several times less than corresponding electric motors.

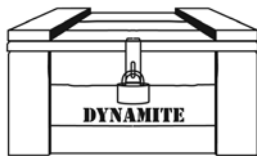

Air motors can be used in the harshest environments. Most P1VAS motors are ATEX certified.



The choice of materials means that they can be used in damp and aggressive environments.



The simple design principle of air motors makes them very easy to service.

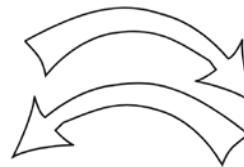

The motors are reversible as standard.



The reliability of air motors is very high, thanks to the design and the low number of moving parts.

P1VAS - Stainless Steel Air Motors

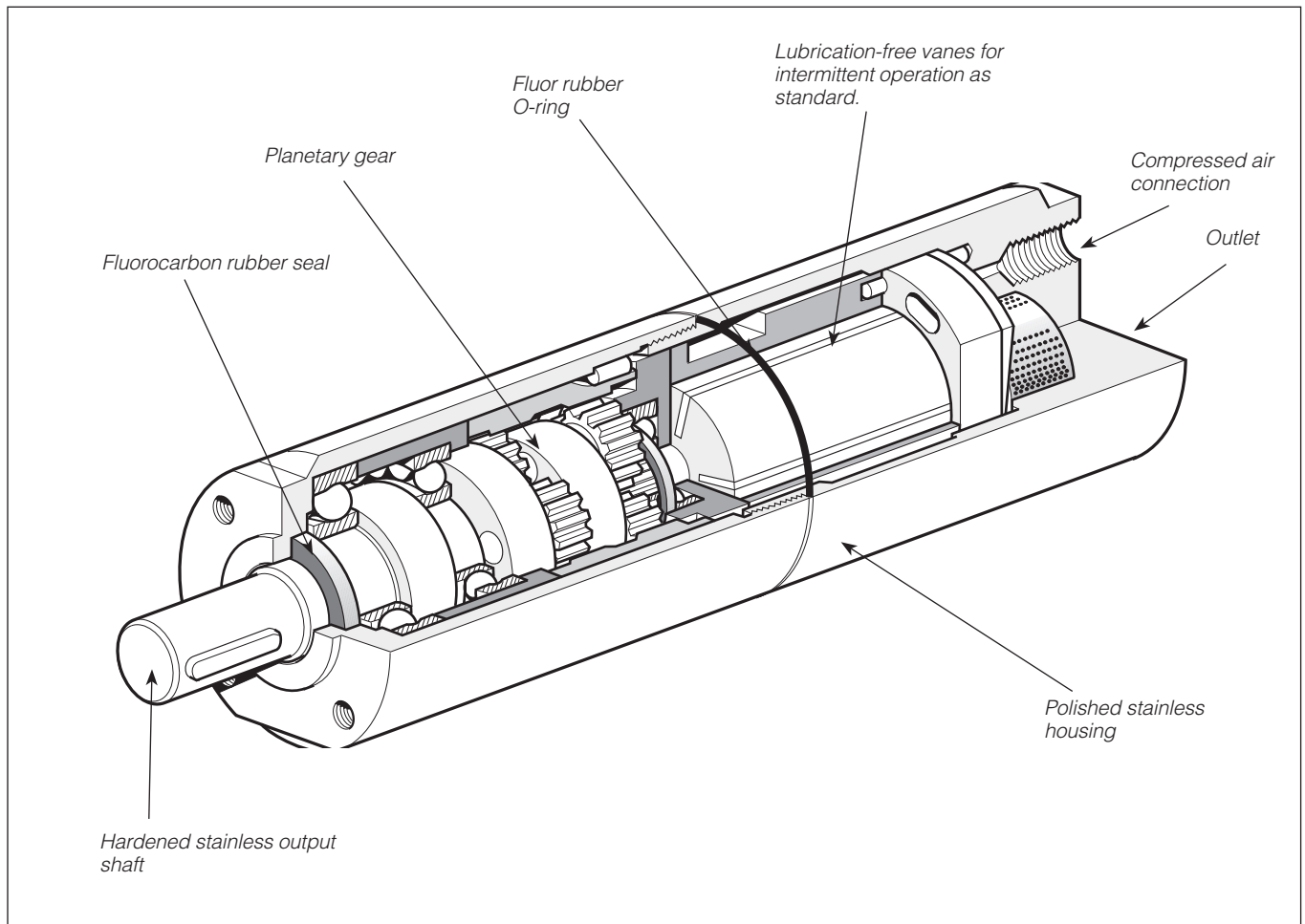

Stainless Steel Air Motors

P1VAS is a range of air motors with all external components made of stainless steel, which means that they can be used in food grade applications, and in all other applications where there is a risk of corrosion.

The range contains seven different sizes, with power ranging from 120 to 1 600 Watts, and speeds from 50 to 22 000 rpm. The air motor and planetary reduction gear are built into a polished stainless steel housing, which is sealed by a fluorocarbon rubber O-ring. The output shaft, which is made of polished stainless steel, is also sealed by a fluorocarbon rubber seal.

Consideration for achieving a clean, hygienic design was given early on in the development of this range of air motors. Thanks to the cylindrical shape, there are no pockets which can accumulate dirt or bacteria. Additionally, the two halves of the motor

body are sealed with an o-ring to prevent contamination. The choice of materials reflects the fact that aggressive cleaning materials are used in food grade applications.

The P1VAS series is designed to be operated in intermittent intervals under non-lubrication conditions. For this reason, no particles of lubricant escape with the exhaust air and the service costs are reduced. This means that the motors can be used directly in food grade applications. The planetary gear, which has one or more reduction stages, is lubricated with an USDA-H1 standard grease, approved for use in food grade applications.

P1VAS - Stainless Steel Air Motors**Technical data****Note:**

All technical data are based on a working pressure of 6 bar and with oil. Speed tolerance accuracy in between clock and anti-clockwise directions is $\pm 10\%$.

Air motor size & type	P1VAS012	P1VAS020	P1VAS030	P1VAS060	P1VAS090	P1VAS160
Nominal power (watts)	120	200	300	600	900	1600
Working pressure (bar)	3 to 7, 6 in explosive atmosphere					
Working temperature (°C)	-20 to +110					
Ambient temperature (°C)	-20 to +40 in explosive atmosphere					
Air flow required (l/min)	300	370	470	850	1400	1600
Min pipe ID, inlet (mm)	6	10	10	12	12	19
Min pipe ID, outlet (mm)	6	10	10	12	12	19
Choice of treatment unit: recommended min air flow (l/min) at p1 7.5 bar and 0.8 bar pressure drop						
	340	410	510	900	1500	1800
Medium	40µm filtered, oil mist or dry unlubricated compressed air					
Oil free operation, indoor	ISO8573-1 purity class 3.4.1					
Oil free operation, outdoor	ISO8573-1 purity class 1.2.1					
Oil operation	1-2 drop per cube meter, ISO8573-1 purity class 3.-.5					
Recommended oil	Foodstuffs industry Klüber oil 4 UH1- 32 N					
Choice of valve: recommended min nominal air flow (l/min) at p1 6 bar and 1 bar pressure drop						
	380	450	550	950	1600	2000
Sound level free outlet (dB(A))	99	100	103	103	106	108
With outlet silencer (dB(A))	92	82	91	94	88	95
Exhaust air removed with pipes to another room	70	71	70	76	80	87

Note:

sound levels are measured at free speed with the measuring instrument positioned 1 meter away from the air motor at an height of 1 meter.

Material specification

Air motor size & type	P1VAS012	P1VAS020	P1VAS030	P1VAS060	P1VAS090	P1VAS160
Planetary gearbox housing	Stainless Steel					
Air motor housing	Stainless steel					
Shaft	Hardened stainless steel					
Key	Hardened stainless steel					
External seal Fluor rubber	Fluor rubber FPM					
Internal steel parts	High grade steel (not stainless)					
Planetary gear grease used in	Grease, Shell Cassida RLS2					
Screws in housing in last planet stage	Surface treated steel					

Accessories**P1V**

Flange bracket	Stainless steel
Foot bracket	Stainless steel
Screws for the mountings	Stainless steel DIN A2

Choice of vanes

0 = Standard vanes

These motors are for the vane type for intermittent lubrication-free operation.

They can operate 70% of the time for up to 15 minutes without lubrication.

With lubrication, these motors can operate 100% of the time.

C = Vanes for continuous lubrication-free operation

This motor is equipped with vanes for continuous lubrication-free operation.

(To obtain the longest possible service life, we recommend no oil in the air.)

Z = Standard spring loaded vanes

All vanes are spring loaded to ensure that they remain pressed against the cylinder when the motor stops. The spring loaded vane option also prevents the vanes from sliding down in their track if vibration is introduced.

The spring loaded vanes therefore provide a higher starting torque, improved starting and low speed characteristics, because the leakage over the vanes is reduced to a minimum.

Refer to the model code on page 27 for ordering vanes with option C or Z.

ATEX Classes

T6 T80°C	II 2G Ex h IIC T6 Gb X II 2D Ex h IIIC T80°C Db X
T5 95°C	II 2G Ex h IIC T5 Gb X II 2D Ex h IIIC T95°C Db X
T4 T130°C	II 2G Ex h IIC T4 Gb X II 2D Ex h IIIC T130°C Db X
T3 T195°C	II 2G Ex h IIC T3 Gb X II 2D Ex h IIIC T195°C Db X

Optimum working speed and torque range

"The performance characteristics of each motor are normally shown in a family of curves, from which torque, power and air consumption can be read off as a function of speed.

Power is zero when the motor is stationary and also when running at free speed (100%) with no load. Maximum power (100%) is normally developed when the motor is driving a load at approximately half the free speed (50%). Torque at free speed is zero, but increases as soon as a load is applied, rising linearly until the motor stalls. As the motor can then stop with the vanes in various positions, it is not possible to specify an exact torque. However, a minimum starting torque is shown in all tables in next pages for each air motor size. Air consumption is greatest at free speed, and decreases with decreasing speed."

Order Code	6 bar		Order Code	6 bar	
	Speed range [rpm]	Torque range [Nm]		Speed range [rpm]	Torque range [Nm]
P1VAS012A*N00	8800 to 11000	0,12 to 0,1	P1VAS060A*D50	5400 to 6750	0,98 to 0,85
P1VAS012A*550	2200 to 2750	0,46 to 0,4	P1VAS060A*550	2200 to 2750	2,3 to 2
P1VAS012A*360	1440 to 1800	0,69 to 0,6	P1VAS060A*400	1600 to 2000	3,22 to 2,8
P1VAS012A*140	560 to 700	1,84 to 1,6	P1VAS060A*300	1200 to 1500	4,37 to 3,8
P1VAS012A*090	360 to 450	2,88 to 2,5	P1VAS060A*200	800 to 1000	6,56 to 5,7
P1VAS012A*060	240 to 300	4,37 to 3,8	P1VAS060A*070	280 to 350	18,75 to 16,3
P1VAS012A*010	-	-	P1VAS060A*050	200 to 250	26,34 to 22,9
P1VAS020A*G00	6400 to 8000	0,28 to 0,24	P1VAS060A*034	136 to 170	38,76 to 33,7
P1VAS020A*460	1840 to 2300	0,92 to 0,8	P1VAS060A*018	72 to 90	36,57 to 31,8
P1VAS020A*240	960 to 1200	1,84 to 1,6	P1VAS090A*C60	5040 to 6300	1,55 to 1,35
P1VAS020A*140	560 to 700	3,11 to 2,7	P1VAS090A*520	2080 to 2600	3,8 to 3,3
P1VAS020A*070	280 to 350	6,21 to 5,4	P1VAS090A*367	1468 to 1835	5,29 to 4,6
P1VAS020A*036	144 to 180	12,19 to 10,6	P1VAS090A*285	1140 to 1425	6,9 to 6
P1VAS020A*018	72 to 90	12,08 to 10,5	P1VAS090A*190	760 to 950	10,35 to 9
P1VAS020A*005	-	-	P1VAS090A*065	260 to 325	30,36 to 26,4
P1VAS030A*E50	5800 to 7250	0,46 to 0,4	P1VAS090A*047	188 to 235	41,98 to 36,5
P1VAS030A*460	1840 to 2300	1,38 to 1,2	P1VAS090A*031	124 to 155	63,71 to 55,4
P1VAS030A*240	960 to 1200	2,76 to 2,4	P1VAS160A*960	3840 to 4800	3,57 to 3,1
P1VAS030A*123	492 to 615	5,35 to 4,65	P1VAS160A*250	1000 to 1250	14,03 to 12,2
P1VAS030A*070	280 to 350	9,37 to 8,15	P1VAS160A*120	480 to 600	29,21 to 25,4
P1VAS030A*036	144 to 180	18,29 to 15,9	P1VAS160A*070	280 to 350	50,14 to 43,6
P1VAS030A*018	72 to 90	15,87 to 13,8	P1VAS160A*032	128 to 160	109,71 to 95,4
P1VAS030A*010	-	-	P1VAS160A*020	80 to 100	76,94 to 66,9
P1VAS030A*005	-	-	P1VAS160A*016	64 to 80	219,65 to 191

* valid for vanes 0, C, Z.

P1V-S Stainless Steel Vane Air Motors with Integrated Planetary Gear boxes

Note:

All technical data are based on a working pressure of 6 bar and with oil lubrication. With oil free operation performances are reduced by 10 to 20%. Speed tolerance accuracy in between clock and anti clockwise directions is ±10%. Note! Inlet and exhaust air flows are critical for reaching the best performances.



Data for Reversible Air Motor Power 120 watts, with Keyed Shaft

Max power	Free speed	Nominal speed	Nominal torque	Min starting torque	Stall torque	Max adm torque	Air consumption	Supply/ Exhaust	Min pipe	Weight	ATEX	Rotation	Vanne Option	Order Code
[watt]	[rpm]	[rpm]		[Nm]	[Nm]	[Nm]	[m3/mm]		[mm]	[kg]				
120	22000	11000	0,10	0,15	0,19	-	0,30	G1/8 G1/8	6 6	0,35	T6 T80°C	L & R	0, C, Z	P1VAS012A0N00
120	5500	2750	0,40	0,60	0,76	-	0,30	G1/8 G1/8	6 6	0,35	T4 T130°C	L & R	0, C, Z	P1VAS012A0550
120	3600	1800	0,60	0,90	1,14	-	0,30	G1/8 G1/8	6 6	0,35	T4 T130°C	L & R	0, C, Z	P1VAS012A0360
120	1400	700	1,60	2,40	3,00	-	0,30	G1/8 G1/8	6 6	0,40	T4 T130°C	L & R	0, C, Z	P1VAS012A0140
120	900	450	2,50	3,80	4,70	-	0,30	G1/8 G1/8	6 6	0,40	T6 T80°C	L & R	0, C, Z	P1VAS012A0090
120	600	300	3,80	-	-	-	0,30	G1/8 G1/8	6 6	0,40	T6 T80°C	L & R	0, C, Z	P1VAS012A0060
120	100	-	-	-	-	-	0,30	G1/8 G1/8	6 6	0,45	T6 T80°C	L & R	0, C, Z	P1VAS012A0010

With Threaded Shaft

120	22000	11000	0,10	0,15	0,19		0,30	G1/8 G1/8	6 6	0,35	T6 T80°C	-	0, C, Z	P1VAS012D0N00
120	5500	2750	0,40	0,60	0,76		0,30	G1/8 G1/8	6 6	0,35	T4 T130°C	-	0, C, Z	P1VAS012D0550
120	3600	1800	0,60	0,90	1,14		0,30	G1/8 G1/8	6 6	0,35	T4 T130°C	-	0, C, Z	P1VAS012D0360
120	1400	700	1,60	2,40	3,00		0,30	G1/8 G1/8	6 6	0,40	T4 T130°C	-	0, C, Z	P1VAS012D0140
120	900	450	2,50	3,80	4,70		0,30	G1/8 G1/8	6 6	0,40	T6 T80°C	-	0, C, Z	P1VAS012D0090
120	600	300	3,80	-	-		0,30	G1/8 G1/8	6 6	0,40	T6 T80°C	-	0, C, Z	P1VAS012D0060
120	100	-	-	-	-		0,30	G1/8 G1/8	6 6	0,45	T6 T80°C	-	0, C, Z	P1VAS012D0010

Details on page 15

Note:

air motor rotation with threaded shaft may be reversed, but when operated anticlockwise, there is a risk that the driven unit may disconnect if it is not locked properly.

P1VAS - Stainless Steel Air Motors

Dimensions [mm] 120 watts

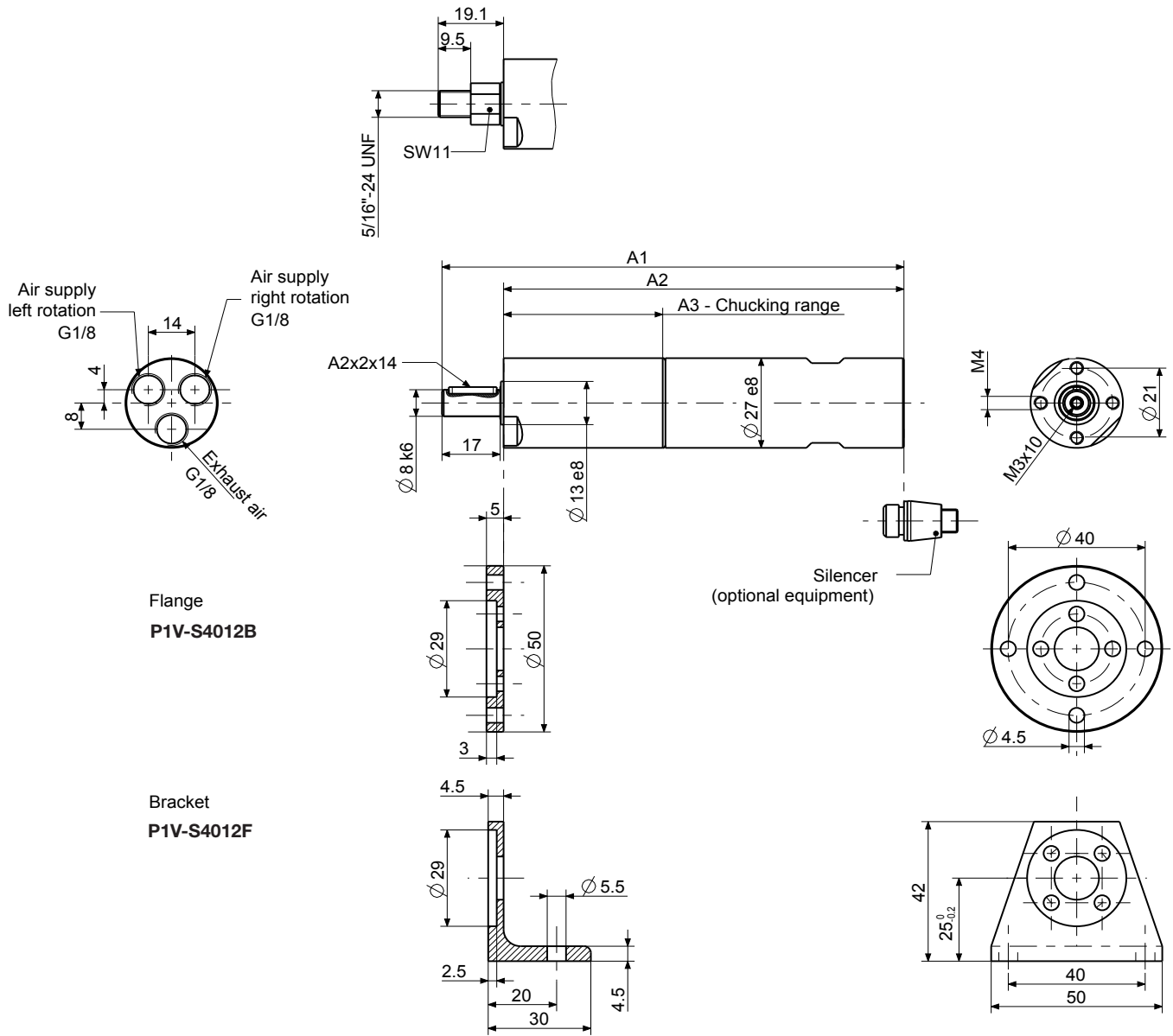

Dimension [mm] 120 watts

A1	A2	A3	Order code		
135	117	46,5	P1VAS012A*N00	P1VAS012A*550	P1VAS012A*360
147,5	129,5	59	P1VAS012A*140	P1VAS012A*090	P1VAS012A*060
160	142	71,5	P1VAS012A*010		

* 0, C, Z

P1VAS - Stainless Steel Air Motors

P1V-S Stainless Steel Vane Air Motors with Integrated Planetary Gear boxes

Note: All technical data are based on a working pressure of 6 bar and with oil lubrication. With oil free operation performances are reduced by 10 to 20%. Speed tolerance accuracy in between clock and anti clockwise directions is ±10%.

Note! Inlet and exhaust air flows are critical for reaching the best performances.



Data for Reversible Air Motor Power 200 watts, with Keyed Shaft

Max power	Free speed	Nominal speed	Nominal torque	Min starting torque	Stall torque	Max adm torque	Air consumption	Supply/Exhaust	Min pipe	Weight	ATEX	Rotation	Vanne Option	Order Code
[watt]	[rpm]	[rpm]		[Nm]	[Nm]	[Nm]	[m3/mm]		[mm]	[kg]				
200	16000	8000	0,24	0,35	0,45	-	0,37	G1/8 G1/4	10 10	0,70	T6 T80°C	L & R	0, C, Z	P1VAS020A0G00
200	4600	2300	0,8	1,20	1,50	-	0,37	G1/8 G1/4	10 10	0,75	T4 T130°C	L & R	0, C, Z	P1VAS020A0460
200	2400	1200	1,6	2,40	3,00	-	0,37	G1/8 G1/4	10 10	0,75	T4 T130°C	L & R	0, C, Z	P1VAS020A0240
200	1400	700	2,7	4,10	5,10	-	0,37	G1/8 G1/4	10 10	0,85	T4 T130°C	L & R	0, C, Z	P1VAS020A0140
200	700	350	5,4	8,20	10,30	-	0,37	G1/8 G1/4	10 10	0,85	T6 T80°C	L & R	0, C, Z	P1VAS020A0070
200	360	180	10,6	15,90	-	20,00	0,37	G1/8 G1/4	10 10	0,85	T6 T80°C	L & R	0, C, Z	P1VAS020A0036
100	180	90	10,5	15,00	-	20,00	0,27	G1/8 G1/4	10 10	0,85	T6 T80°C	L & R	0, C, Z	P1VAS020A0018
180	50	-	-	-	-	20,00	0,34	G1/8 G1/4	10 10	0,95	T6 T80°C	L & R	0, C, Z	P1VAS020A0005

With Treaded Shaft

200	16000	8000	0,24	0,35	0,45	-	0,37	G1/8 G1/4	10 10	0,70	T6 T80°C	-	0, C, Z	P1VAS020D0G00
200	4600	2300	0,8	1,20	1,50	-	0,37	G1/8 G1/4	10 10	0,75	T4 T130°C	-	0, C, Z	P1VAS020D0460
200	2400	1200	1,6	2,40	3,00	-	0,37	G1/8 G1/4	10 10	0,75	T4 T130°C	-	0, C, Z	P1VAS020D0240
200	1400	700	2,7	4,10	5,10	-	0,37	G1/8 G1/4	10 10	0,85	T4 T130°C	-	0, C, Z	P1VAS020D0140
200	700	350	5,4	8,20	10,30	-	0,37	G1/8 G1/4	10 10	0,85	T6 T80°C	-	0, C, Z	P1VAS020D0070
200	360	180	10,6	15,90	-	20,00	0,37	G1/8 G1/4	10 10	0,85	T6 T80°C	-	0, C, Z	P1VAS020D0036
100	180	90	10,5	15,00	-	20,00	0,27	G1/8 G1/4	10 10	0,85	T6 T80°C	-	0, C, Z	P1VAS020D0018
180	50	-	-	-	-	20,00	0,34	G1/8 G1/4	10 10	0,95	T6 T80°C	-	0, C, Z	P1VAS020D0005

Max. adm torque is restriction from the gear box Details on page 15

Note:

air motor rotation with threaded shaft may be reversed, but when operated anticlockwise, there is a risk that the driven unit may disconnect if it is not locked properly.

Data for Reversible Air Motor Power 300 watts, with Keyed Shaft

Max power	Free speed	Nominal speed	Nominal torque	Min starting torque	Stall torque	Max adm torque	Air consumption	Supply/Exhaust	Min pipe	Weight	ATEX	Rotation	Vanne Option	Order Code
[watt]	[rpm]	[rpm]		[Nm]	[Nm]	[Nm]	[m3/mm]		[mm]	[kg]				
300	14500	7250	0,40	0,60	0,76	-	0,37	G1/8 G1/4	10 10	0,70	T6 T80°C	L & R	0, C, Z	P1VAS030A0E50
300	4600	2300	1,20	1,90	2,20	-	0,37	G1/8 G1/4	10 10	0,75	T4 T130°C	L & R	0, C, Z	P1VAS030A0460
300	2400	1200	2,40	3,60	4,50	-	0,37	G1/8 G1/4	10 10	0,75	T4 T130°C	L & R	0, C, Z	P1VAS030A0240
300	1230	615	4,65	6,95	8,80	-	0,37	G1/8 G1/4	10 10	0,85	T4 T130°C	L & R	0, C, Z	P1VAS030A0123
300	700	350	8,15	12,25	15,50	-	0,37	G1/8 G1/4	10 10	0,85	T6 T80°C	L & R	0, C, Z	P1VAS030A0070
300	360	180	15,90	23,80	30,20	-	0,37	G1/8 G1/4	10 10	0,85	T6 T80°C	L & R	0, C, Z	P1VAS030A0036
130	180	90	13,80	21,00	26,20	-	0,27	G1/8 G1/4	10 10	0,85	T6 T80°C	L & R	0, C, Z	P1VAS030A0018
300	100	-	-	-	-	36,00	0,34	G1/8 G1/4	10 10	0,95	T6 T80°C	L & R	0, C, Z	P1VAS030A0010
280	50	-	-	-	-	36,00	0,47	G1/4 G1/4	10 10	1,25	T6 T80°C	L & R	0, C, Z	P1VAS030A0005

With Treaded Shaft

300	14500	7250	0,40	0,60	0,76	-	0,47	G1/4 G1/4	10 10	1,00	T6 T80°C	-	0, C, Z	P1VAS030D0E50
300	4600	2300	1,20	1,90	2,20	-	0,47	G1/4 G1/4	10 10	1,05	T3 T195°C	-	0, C, Z	P1VAS030D0460
300	2400	1200	2,40	3,60	4,50	-	0,47	G1/4 G1/4	10 10	1,05	T4 T130°C	-	0, C, Z	P1VAS030D0240
300	1230	615	4,65	6,95	8,80	-	0,47	G1/4 G1/4	10 10	1,10	T4 T130°C	-	0, C, Z	P1VAS030D0123
300	700	350	8,15	12,25	15,50	-	0,47	G1/4 G1/4	10 10	1,15	T6 T80°C	-	0, C, Z	P1VAS030D0070
300	360	180	15,90	23,80	30,20	-	0,47	G1/4 G1/4	10 10	1,15	T6 T80°C	-	0, C, Z	P1VAS030D0036
130	180	90	13,80	21,00	26,20	-	0,28	G1/4 G1/4	10 10	1,15	T6 T80°C	-	0, C, Z	P1VAS030D0018
300	100	-	-	-	-	36,00	0,47	G1/4 G1/4	10 10	1,25	T6 T80°C	-	0, C, Z	P1VAS030D0010
280	50	-	-	-	-	36,00	0,47	G1/4 G1/4	10 10	1,25	T6 T80°C	-	0, C, Z	P1VAS030D0005

Max. adm torque is restriction from the gear box Details on page 15

Note:

air motor rotation with threaded shaft may be reversed, but when operated anticlockwise, there is a risk that the driven unit may disconnect if it is not locked properly.

P1VAS - Stainless Steel Air Motors

Dimensions [mm] 200, 300 watts

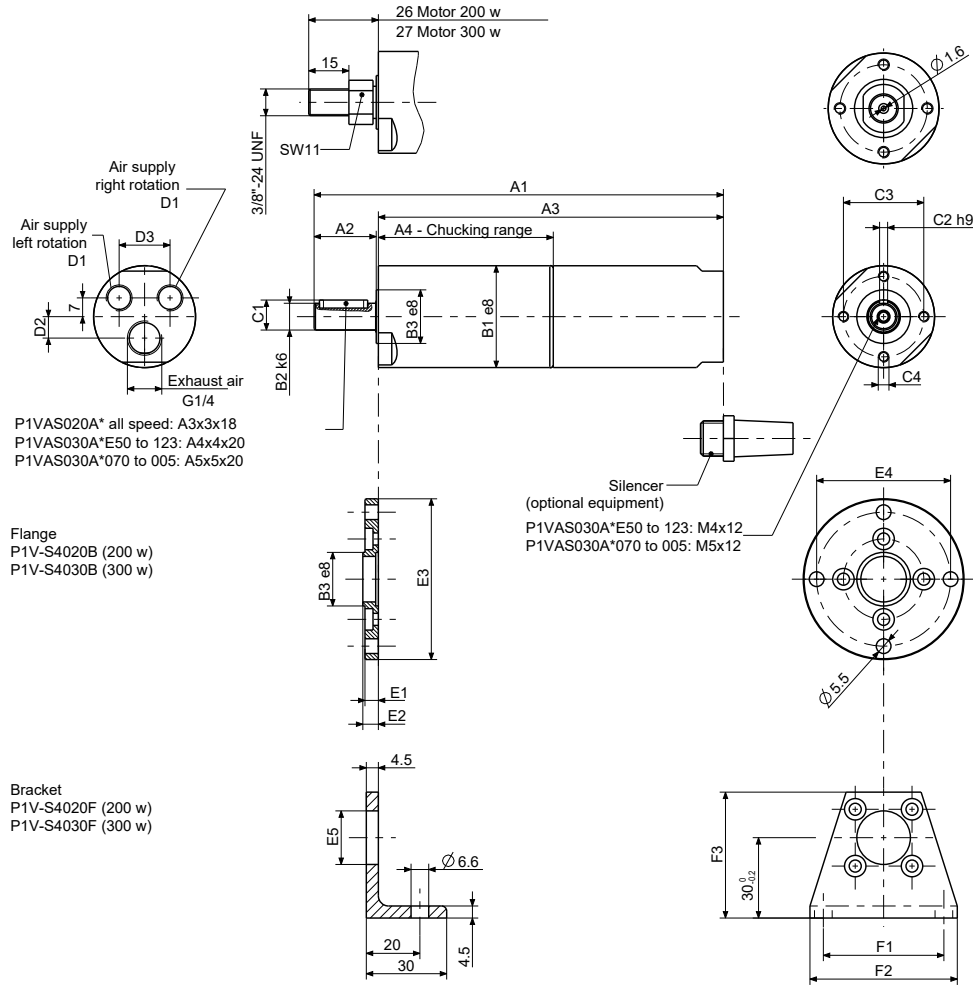

Dimension [mm] 200 watts

* 0, C, Z

A1	A2	A3	A4	B1	B2	B3	C1	C2	C3	C4	Order code			
152,5	23	128,5	65	38	10	20	11,2	3	30	M4	P1VAS020A*G00	P1VAS020A*460	P1VAS020A*240	
168	23	144,5	81	38	10	20	11,2	3	30	M4	P1VAS020A*140	P1VAS020A*070	P1VAS020A*036	P1VAS020A*018
184,5	23	160,5	97	38	10	20	11,2	3	30	M4	P1VAS020A*005			

D1	D2	D3	B3	E1	E2	E3	E4	E5	F1	F2	F3	Order code			
G1/8	8	19	20	5	5,8	60	50	17	45	55	47	P1VAS020A*G00	P1VAS020A*460	P1VAS020A*240	
G1/8	8	19	20	5	5,8	60	50	17	45	55	47	P1VAS020A*140	P1VAS020A*070	P1VAS020A*036	P1VAS020A*018
G1/8	8	19	20	5	5,8	60	50	17	45	55	47	P1VAS020A*005			
G1/4	11	20	24	6	6,8	65	55	21	50	60	48	P1VAS030A*010	P1VAS030A*005		

Dimension [mm] 300 watts

A1	A2	A3	A4	B1	B2	B3	C1	C2	C3	C4	Order code			
171	27	143	66	42	12	24	13,5	4	34	M5	P1VAS030A*E50	P1VAS030A*460	P1VAS030A*240	
187	27	159	83	42	12	24	13,5	4	34	M5	P1VAS030A*123			
191	30	159	83	42	14	24	16	5	34	M5	P1VAS030A*070	P1VAS030A*036	P1VAS030A*018	
196	30	164	83	42	14	24	16	5	34	M5	P1VAS030A*010	P1VAS030A*005		

D1	D2	D3	B3	E1	E2	E3	E4	E5	F1	F2	F3	Order code			
G1/4	11	20	20	5	6,8	60	50	17	45	55	47	P1VAS030A*E50	P1VAS030A*460	P1VAS030A*240	
G1/4	11	20	20	5	6,8	60	50	17	45	55	47	P1VAS030A*123			
G1/4	11	20	24	6	6,8	65	55	21	50	60	48	P1VAS030A*070	P1VAS030A*036	P1VAS030A*018	
G1/4	11	20	24	6	6,8	65	55	21	50	60	48	P1VAS030A*010	P1VAS030A*005		

P1V-S Stainless Steel Vane Air Motors with Integrated Planetary Gear boxes

Note: All technical data are based on a working pressure of 6 bar and with oil lubrication. With oil free operation performances are reduced by 10 to 20%. Speed tolerance accuracy in between clock and anti clockwise directions is ±10%.

Note! Inlet and exhaust air flows are critical for reaching the best performances.

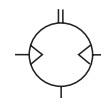

Data for Reversible Air Motor Power 600 watts, with Keyed Shaft

Max power	Free speed	Nominal speed	Nominal torque	Min starting torque	Stall torque	Max adm torque	Air consumption	Supply/ Exhaust	Min pipe	Weight	ATEX	Rotation	Vanne Option	Order Code
[watt]	[rpm]	[rpm]		[Nm]	[Nm]	[Nm]	[m3/mm]		[mm]	[kg]				
600	13500	6750	0,85	1,25	1,60	-	0,85	G3/8 G1/2	12 12	2,20	T6 T80°C	L & R	0, C, Z	P1VAS060A0D50
600	5500	2750	2,00	3,10	3,90	-	0,85	G3/8 G1/2	12 12	2,70	T6 T80°C	L & R	0, C, Z	P1VAS060A0550
600	4000	2000	2,80	4,30	5,40	-	0,85	G3/8 G1/2	12 12	2,30	T3 T195°C	L & R	0, C, Z	P1VAS060A0400
600	3000	1500	3,80	5,70	7,20	-	0,85	G3/8 G1/2	12 12	2,30	T4 T130°C	L & R	0, C, Z	P1VAS060A0300
600	2000	1000	5,70	8,50	10,80	-	0,85	G3/8 G1/2	12 12	2,30	T4 T130°C	L & R	0, C, Z	P1VAS060A0200
600	700	350	16,30	24,50	31,10	-	0,85	G3/8 G1/2	12 12	2,60	T6 T80°C	L & R	0, C, Z	P1VAS060A0070
600	500	250	22,90	34,30	43,50	-	0,85	G3/8 G1/2	12 12	2,70	T6 T80°C	L & R	0, C, Z	P1VAS060A0050
600	340	170	33,70	50,60	64,00	-	0,85	G3/8 G1/2	12 12	2,70	T6 T80°C	L & R	0, C, Z	P1VAS060A0034
300	180	90	31,80	47,70	60,40	-	0,55	G3/8 G1/2	12 12	2,70	T6 T80°C	L & R	0, C, Z	P1VAS060A0018

Max. adm torque is restriction from the gear box 2,7 Details on page 15

Data for Reversible Air Motor Power 900 watts, with Keyed Shaft

Max power	Free speed	Nominal speed	Nominal torque	Min starting torque	Stall torque	Max adm torque	Air consumption	Supply/ Exhaust	Min pipe	Weight	ATEX	Rotation	Vanne Option	Order Code
[watt]	[rpm]	[rpm]		[Nm]	[Nm]	[Nm]	[m3/mm]		[mm]	[kg]				
900	12600	6300	1,35	2,00	2,60	-	1,40	G3/8 G1/2	12 12	3,55	T6 T80°C	L & R	0, C, Z	P1VAS090A0C60
900	5200	2600	3,30	4,90	6,20	-	1,40	G3/8 G1/2	12 12	3,55	T6 T80°C	L & R	0, C, Z	P1VAS090A0520
900	3670	1835	4,60	7,00	8,90	-	1,40	G3/8 G1/2	12 12	3,65	T3 T195°C	L & R	0, C, Z	P1VAS090A0367
900	2850	1425	6,00	9,00	11,40	-	1,40	G3/8 G1/2	12 12	3,65	T4 T130°C	L & R	0, C, Z	P1VAS090A0285
900	1900	950	9,00	14,50	17,10	-	1,40	G3/8 G1/2	12 12	3,65	T4 T130°C	L & R	0, C, Z	P1VAS090A0190
900	650	325	26,40	39,60	50,20	-	1,40	G3/8 G1/2	12 12	3,95	T6 T80°C	L & R	0, C, Z	P1VAS090A0065
900	470	235	36,50	54,80	69,40	-	1,40	G3/8 G1/2	12 12	3,95	T6 T80°C	L & R	0, C, Z	P1VAS090A0047
900	310	155	55,40	83,10	105,30	-	1,40	G3/8 G1/2	12 12	3,95	T6 T80°C	L & R	0, C, Z	P1VAS090A0031

Max. adm torque is restriction from the gear box Details on page 15

Data for Reversible Air Motor Power 1600 watts, with Keyed Shaft

1600	9600	4800	3,10	4,70	6,05	-	1,60	G1/2 G3/4	19 19	5,90	T6 T80°C	L & R	0, C, Z	P1VAS160A0960
1600	2500	1250	12,20	18,30	23,20	-	1,60	G1/2 G3/4	19 19	6,10	T3 T195°C	L & R	0, C, Z	P1VAS160A0250
1600	1200	600	25,40	38,20	48,30	-	1,60	G1/2 G3/4	19 19	6,10	T4 T130°C	L & R	0, C, Z	P1VAS160A0120
1600	700	350	43,60	65,40	82,90	-	1,60	G1/2 G3/4	19 19	6,70	T4 T130°C	L & R	0, C, Z	P1VAS160A0070
1600	320	160	95,40	143,20	181,40	-	1,60	G1/2 G3/4	19 19	6,70	T4 T130°C	L & R	0, C, Z	P1VAS160A0032
700	200	100	66,90	100,00	125,00	-	1,60	G1/2 G3/4	19 19	6,70	T6 T80°C	L & R	0, C, Z	P1VAS160A0020
1600	160	80	191,00	-	-	220,00	1,60	G1/2 G3/4	19 19	8,00	T6 T80°C	L & R	0, C, Z	P1VAS160A0016

Max. adm torque is restriction from the gear box Details on page 15

Note:

air motor rotation with threaded shaft may be reversed, but when operated anticlockwise, there is a risk that the driven unit may disconnect if it is not locked properly.

Dimensions [mm] 600 watts

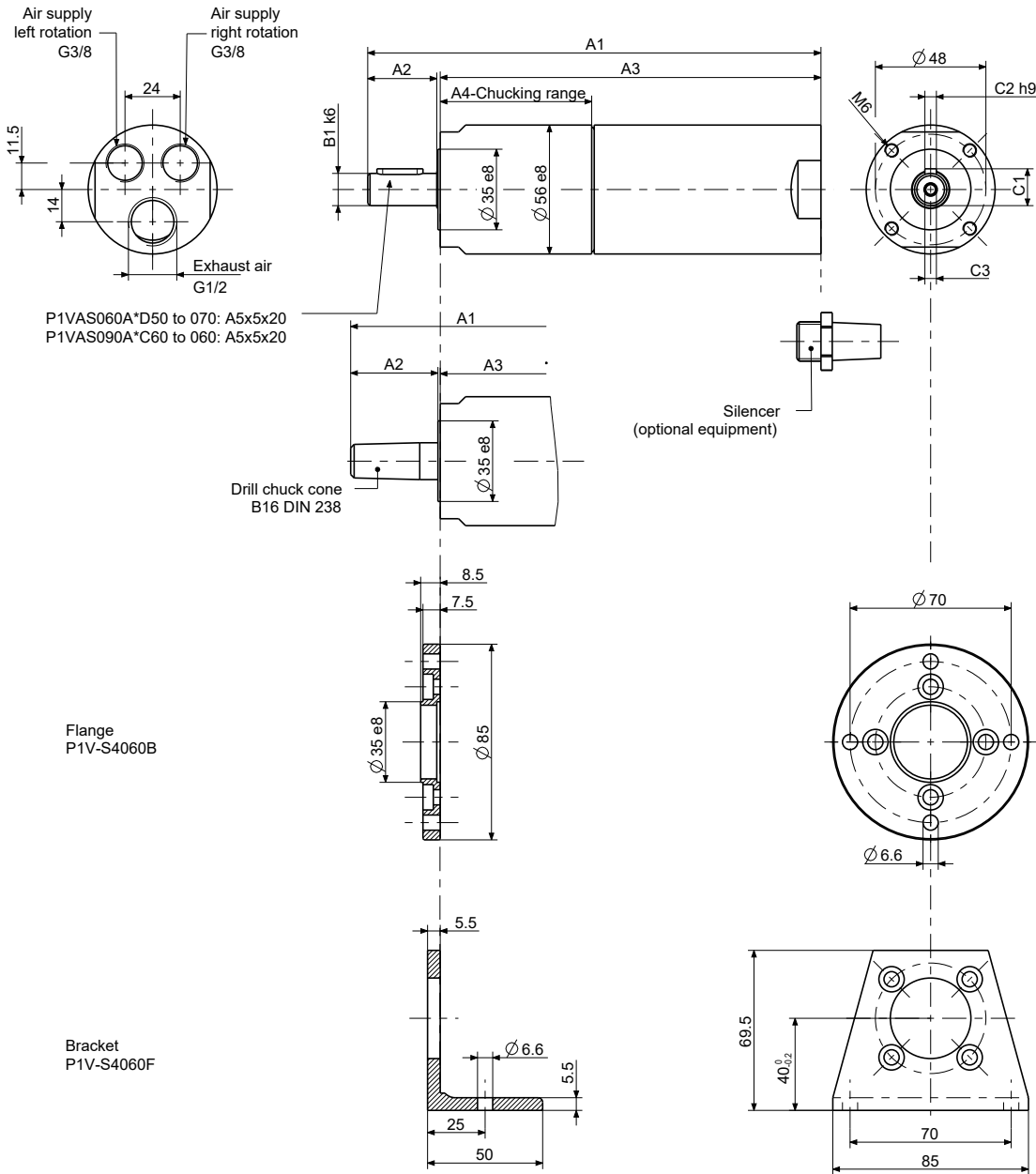

Dimension [mm] 600 watts

A1	A2	A3	A4	B1	C1	C2	C3	Order code			
197	30,5	165,5	66	14	16	5	M5x12	P1VAS060A*D50	P1VAS060A*550	P1VAS060A*400	P1VAS060A*300
215	30,5	183,5	84	14	16	5	M5x12	P1VAS060A*200	P1VAS060A*070		
217	35	180	80,5	19	21,5	6	M6x12	P1VAS060A*050	P1VAS060A*034	P1VAS060A*018	

* 0, C, Z

Dimensions [mm] 900 watts

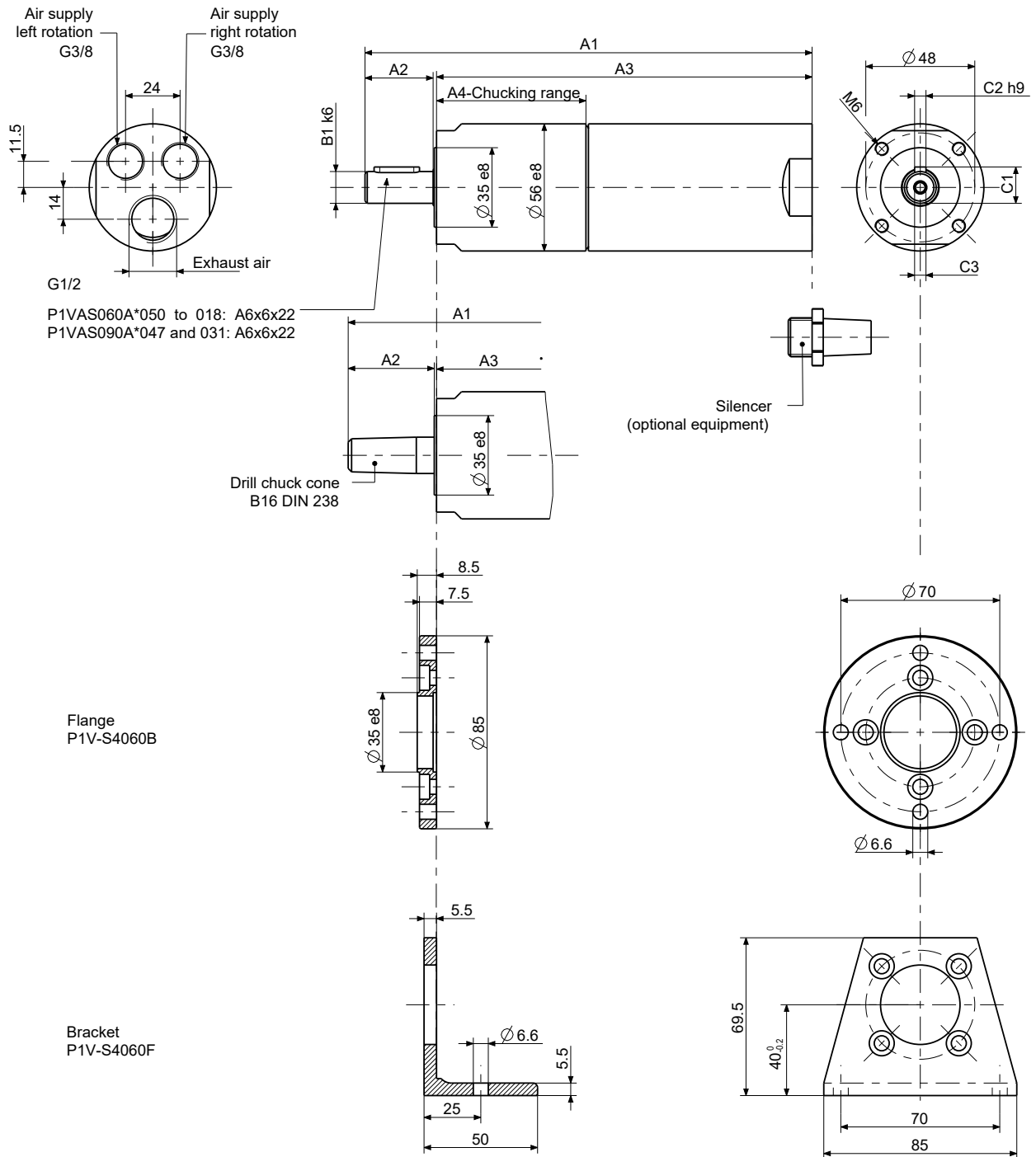

Dimension [mm] 900 watts

A1	A2	A3	A4	B1	C1	C2	C3	Order code			
222	30,5	190,5	66	14	16	5	M5x12	P1VAS090A*C60	P1VAS090A*520	P1VAS090A*367	P1VAS090A*285
240	30,5	208,5	84	14	16	5	M5x12	P1VAS090A*190	P1VAS090A*065		
242	35	205	80,5	19	21,5	6	M6x12	P1VAS090A*047	P1VAS090A*031		

* 0, C, Z

P1VAS - Stainless Steel Air Motors

Dimensions [mm] 1600 watts

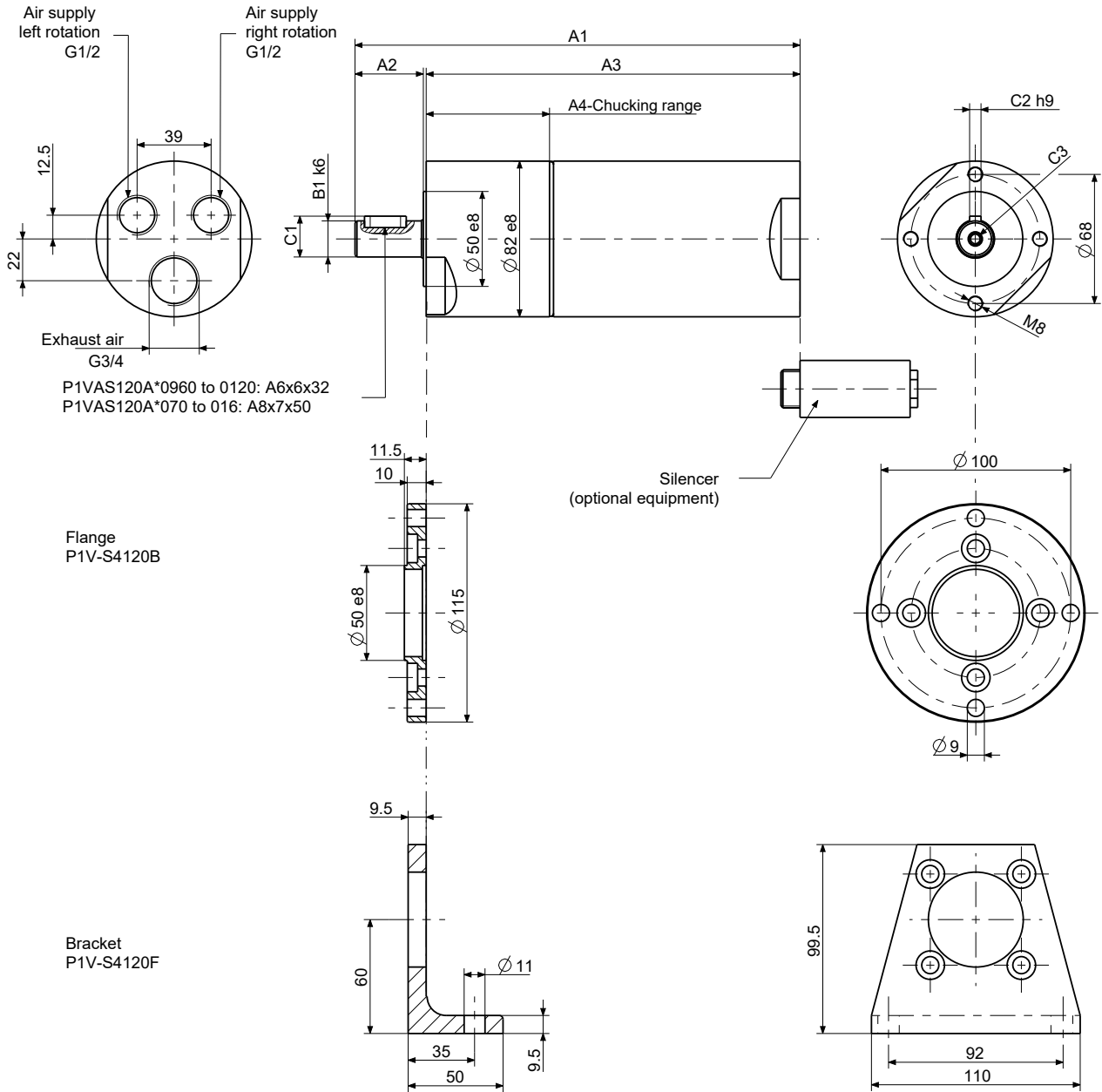

Dimension [mm] 1600 watts

A1	A2	A3	A4	B1	C1	C2	C3	Order code
235	35	197	65	19	21,5	6	M6x15	P1VAS160A*960 P1VAS160A*250 P1VAS160A*120
268	60	205	73	28	31	8	M10x20	P1VAS160A*070 P1VAS160A*032 P1VAS160A*020
311,5	61,5	248,5	116,5	28	31	8	M10x20	P1VAS160A*016

* 0, C, Z

Service kits

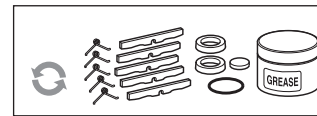
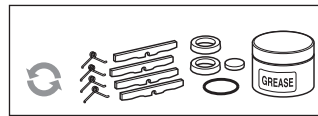
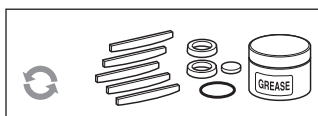
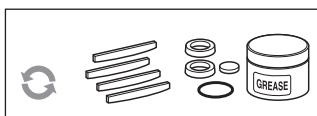

Optional function "0"

Service kits, vanes for intermittent lubrication-free operation

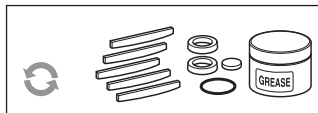
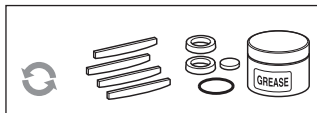

Optional function "Z"

Service kits, spring-loaded vanes for intermittent lubrication-free operation

Optional function "C"

Service kits, vanes for continuous lubrication-free operation

Lubrication and service life

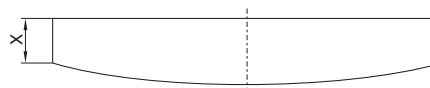

Air motor	Dimensions on new vanes X (mm), type of vanes			
	0	Z	C	M
P1VAS012	4.2	4.2	4.2	4.2
P1VAS020	6.5	6.0	6.0	6.0
P1VAS030	6.8	6.2	6.8	6.2
P1VAS060	9.0	9.0	9.0	9.0
P1VAS090	X	X	X	X
P1VAS160	14.7	14.0	14.0	14.0

Air motor	Dimensions on vanes X (mm), type of vanes			
	0	Z	C	M
P1VAS012	3.3	3.3	3.3	3.3
P1VAS020	5.8	5.3	5.3	5.3
P1VAS030	6.0	5.2	6.0	5.2
P1VAS060	6.0	6.0	6.0	6.0
P1VAS090	X	X	X	X
P1VAS160	14.2	13.5	13.5	13.5

The following normal service intervals should be applied to in order to guarantee problem-free operation in air motors working continuously at load speeds.

Intermittent lubrication-free operation of motors with standard vanes, option 0

Duty cycle : 70%
 Max. duration of intermittent use : 15 minutes
 Filtering 40 µm : 750 hours of operation*
 Filtering 5 µm : 1,000 hours of operation*

Continuous lubricated operation of motors with standard vanes, option 0

Duty cycle : Continuous
 Quantity of oil : 1 drop per m³ of air
 Filtering 40 µm : 1,000 hours of operation*
 Filtering 5 µm : 2,000 hours of operation*

Note! After 1000 hours of operation, the grease in the planetary gearbox must be changed

Continuous lubrication-free operation of motors equipped with vanes, option C

Duty cycle : Continuous
 Filtering 40 µm : 750 hours of operation*
 Filtering 5 µm : 1,000 hours of operation*

The first service is due after approximately 500 hours of operation. After the first service, the service interval is determined by the degree of vane wear*. The table below shows new dimensions and the minimum dimensions of worn vanes.



* The specified hours of operation apply when the motor is running at the speed corresponding to maximum power (load speed). This is approximately half free speed. If the motor operates at higher speeds, the service interval is shorter. If the motor operates at lower speeds, the service interval is longer.

P1VAS - Stainless Steel Air Motors

Service kits

Air Motor Code		New x Value [mm]	Worm	0 Standard vanes	C Lubrication-free Service Kit Order Code	Z Spring loaded
P1VAS012A*N00	P1VAS012D*N00			P1VAS6/4455801C	P1VAS6/4455801D	P1VAS6/4455804C
P1VAS012A*550	P1VAS012D*550			P1VAS6/4455801G	P1VAS6/4455801H	P1VAS6/4455804B
P1VAS012A*360	P1VAS012D*360			P1VAS6/4455801G	P1VAS6/4455801H	P1VAS6/4455804B
P1VAS012A*140	P1VAS012D*140	4.2	3.3	P1VAS6/4455801G	P1VAS6/4455801H	P1VAS6/4455804B
P1VAS012A*090	P1VAS012D*090			P1VAS6/4455801G	P1VAS6/4455801H	P1VAS6/4455804B
P1VAS012A*060	P1VAS012D*060			P1VAS6/4455801G	P1VAS6/4455801H	P1VAS6/4455804B
P1VAS012A*010	P1VAS012D*010			P1VAS6/4455801G	P1VAS6/4455801H	P1VAS6/4455804B
P1VAS020A*G00	P1VAS020D*G00			P1VAS6/4447851E	P1VAS6/4447853C	P1VAS6/4447854C
P1VAS020A*460	P1VAS020D*460			P1VAS6/4447851F	P1VAS6/4447853B	P1VAS6/4447854B
P1VAS020A*240	P1VAS020D*240			P1VAS6/4447851A	P1VAS6/4447853B	P1VAS6/4447854B
P1VAS020A*140	P1VAS020D*140	6.5 to 6	5.8 to 5.3	P1VAS6/4447851A	P1VAS6/4447853B	P1VAS6/4447854B
P1VAS020A*070	P1VAS020D*070			P1VAS6/4447851A	P1VAS6/4447853B	P1VAS6/4447854B
P1VAS020A*036	P1VAS020D*036			P1VAS6/4447851F	P1VAS6/4447853B	P1VAS6/4447854B
P1VAS020A*018	P1VAS020D*018			P1VAS6/4447851F	P1VAS6/4447853B	P1VAS6/4447854B
P1VAS020A*005	P1VAS020D*005			P1VAS6/4447851F	P1VAS6/4447853B	P1VAS6/4447854B
P1VAS030A*E50	P1VAS030D*E50			P1VAS6/4447861L	P1VAS6/4447863C	P1VAS6/4447864C
P1VAS030A*460	P1VAS030D*460			P1VAS6/4447861M	P1VAS6/4447863B	P1VAS6/4447864B
P1VAS030A*240	P1VAS030D*240			P1VAS6/4447861M	P1VAS6/4447863B	P1VAS6/4447864B
P1VAS030A*123	P1VAS030D*123	6.8 to 6.2	6 to 5.2	P1VAS6/4447861M	P1VAS6/4447863B	P1VAS6/4447864B
P1VAS030A*070	P1VAS030D*070			P1VAS6/4447861M	P1VAS6/4447863B	P1VAS6/4447864B
P1VAS030A*036	P1VAS030D*036			P1VAS6/4447861M	P1VAS6/4447863B	P1VAS6/4447864B
P1VAS030A*018	P1VAS030D*018			P1VAS6/4447861M	P1VAS6/4447863B	P1VAS6/4447864B
P1VAS030A*010	P1VAS030D*010			P1VAS6/4447861M	P1VAS6/4447863B	P1VAS6/4447864B
P1VAS030A*005	P1VAS030D*005			P1VAS6/4447861M	P1VAS6/4447863B	P1VAS6/4447864B
P1VAS060A*D50	-			P1VAS6/4447871K	P1VAS6/4447873E	P1VAS6/4447874E
P1VAS060A*550	-			P1VAS6/4447871K	P1VAS6/4447873E	P1VAS6/4447874E
P1VAS060A*400	-			P1VAS6/4447871M	P1VAS6/4447873C	P1VAS6/4447874C
P1VAS060A*300	-			P1VAS6/4447871M	P1VAS6/4447873C	P1VAS6/4447874C
P1VAS060A*200	-	9	6	P1VAS6/4447871M	P1VAS6/4447873C	P1VAS6/4447874C
P1VAS060A*070	-			P1VAS6/4447871M	P1VAS6/4447873C	P1VAS6/4447874C
P1VAS060A*050	-			P1VAS6/4447871L	P1VAS6/4447873D	P1VAS6/4447874D
P1VAS060A*034	-			P1VAS6/4447871L	P1VAS6/4447873D	P1VAS6/4447874D
P1VAS060A*018	-			P1VAS6/4447871L	P1VAS6/4447873D	P1VAS6/4447874D
P1VAS090A*C60	-			P1VAS6/4449191G	P1VAS6/1191563A	P1VAS6/1191564A
P1VAS090A*520	-			P1VAS6/4449191G	P1VAS6/1191563A	P1VAS6/1191564A
P1VAS090A*367	-			P1VAS6/4449191E	P1VAS6/1191563B	P1VAS6/1191564B
P1VAS090A*285	-			P1VAS6/4449191E	P1VAS6/1191563B	P1VAS6/1191564B
P1VAS090A*190	-			P1VAS6/4449191E	P1VAS6/1191563B	P1VAS6/1191564B
P1VAS090A*065	-			P1VAS6/4449191E	P1VAS6/1191563B	P1VAS6/1191564B
P1VAS090A*047	-			P1VAS6/4449191F	P1VAS6/1191563C	P1VAS6/1191654C
P1VAS090A*031	-			P1VAS6/4449191F	P1VAS6/1191563C	P1VAS6/1191654C
P1VAS160A*960	-			P1VAS6/4447881D	P1VAS6/4447883D	P1VAS6/4447884D
P1VAS160A*250	-			P1VAS6/4447881E	P1VAS6/4447883E	P1VAS6/4447884E
P1VAS160A*120	-	14.7 to 14	14.2 to 13.5	P1VAS6/4447881E	P1VAS6/4447883E	P1VAS6/4447884E
P1VAS160A*070	-			P1VAS6/4447881F	P1VAS6/4447883F	P1VAS6/4447884F
P1VAS160A*032	-			P1VAS6/4447881F	P1VAS6/4447883F	P1VAS6/4447884F
P1VAS160A*020	-			P1VAS6/4447881C	P1VAS6/4447883C	P1VAS6/4447884C
P1VAS160A*016	-			P1VAS6/4447881D	P1VAS6/4447883D	P1VAS6/4447884D

*0, C or Z

P1VAS - Stainless Steel Air Motors

Order code key

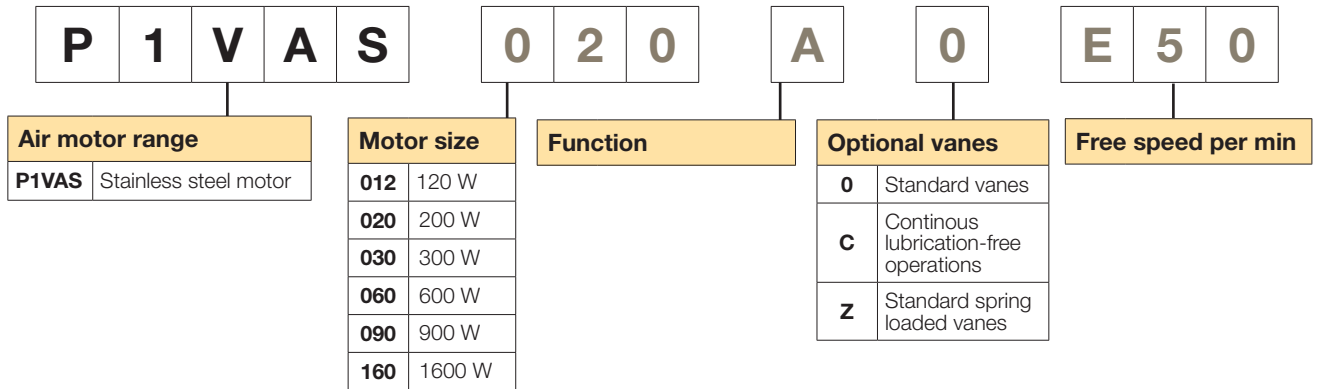

This model code can not be used for creating new part numbers except for optional vanes.
 All possible combinations between motor size, function and free speed are in the previous pages.

Parker Worldwide

Europe, Middle East, Africa

AE – United Arab Emirates,
Dubai

Tel: +971 4 8127100
parker.me@parker.com

AT – Austria, Wiener Neustadt

Tel: +43 (0)2622 23501-0
parker.austria@parker.com

AT – Eastern Europe, Wiener
Neustadt

Tel: +43 (0)2622 23501 900
parker.easteurope@parker.com

AZ – Azerbaijan, Baku

Tel: +994 50 2233 458
parker.azerbaijan@parker.com

BE/LU – Belgium, Nivelles

Tel: +32 (0)67 280 900
parker.belgium@parker.com

BG – Bulgaria, Sofia

Tel: +359 2 980 1344
parker.bulgaria@parker.com

BY – Belarus, Minsk

Tel: +48 (0)22 573 24 00
parker.poland@parker.com

CH – Switzerland, Etoy

Tel: +41 (0)21 821 87 00
parker.switzerland@parker.com

CZ – Czech Republic, Klecany

Tel: +420 284 083 111
parker.czechrepublic@parker.com

DE – Germany, Kaarst

Tel: +49 (0)2131 4016 0
parker.germany@parker.com

DK – Denmark, Ballerup

Tel: +45 43 56 04 00
parker.denmark@parker.com

ES – Spain, Madrid

Tel: +34 902 330 001
parker.spain@parker.com

FI – Finland, Vantaa

Tel: +358 (0)20 753 2500
parker.finland@parker.com

FR – France, Contamine s/Arve

Tel: +33 (0)4 50 25 80 25
parker.france@parker.com

GR – Greece, Athens

Tel: +30 210 933 6450
parker.greece@parker.com

HU – Hungary, Budaörs

Tel: +36 23 885 470
parker.hungary@parker.com

IE – Ireland, Dublin

Tel: +353 (0)1 466 6370
parker.ireland@parker.com

IT – Italy, Corsico (MI)

Tel: +39 02 45 19 21
parker.italy@parker.com

KZ – Kazakhstan, Almaty

Tel: +7 7273 561 000
parker.easteurope@parker.com

NL – The Netherlands, Oldenzaal

Tel: +31 (0)541 585 000
parker.nl@parker.com

NO – Norway, Asker

Tel: +47 66 75 34 00
parker.norway@parker.com

PL – Poland, Warsaw

Tel: +48 (0)22 573 24 00
parker.poland@parker.com

PT – Portugal, Leca da Palmeira

Tel: +351 22 999 7360
parker.portugal@parker.com

RO – Romania, Bucharest

Tel: +40 21 252 1382
parker.romania@parker.com

RU – Russia, Moscow

Tel: +7 495 645-2156
parker.russia@parker.com

SE – Sweden, Spånga

Tel: +46 (0)8 59 79 50 00
parker.sweden@parker.com

SK – Slovakia, Banská Bystrica

Tel: +421 484 162 252
parker.slovakia@parker.com

SL – Slovenia, Novo Mesto

Tel: +386 7 337 6650
parker.slovenia@parker.com

TR – Turkey, Istanbul

Tel: +90 216 4997081
parker.turkey@parker.com

UA – Ukraine, Kiev

Tel: +48 (0)22 573 24 00
parker.poland@parker.com

UK – United Kingdom, Warwick

Tel: +44 (0)1926 317 878
parker.uk@parker.com

ZA – South Africa, Kempton Park

Tel: +27 (0)11 961 0700
parker.southafrica@parker.com

North America

CA – Canada, Milton, Ontario

Tel: +1 905 693 3000

US – USA, Cleveland

Tel: +1 216 896 3000

Asia Pacific

AU – Australia, Castle Hill

Tel: +61 (0)2-9634 7777

CN – China, Shanghai

Tel: +86 21 2899 5000

HK – Hong Kong

Tel: +852 2428 8008

IN – India, Mumbai

Tel: +91 22 6513 7081-85

JP – Japan, Tokyo

Tel: +81 (0)3 6408 3901

KR – South Korea, Seoul

Tel: +82 2 559 0400

MY – Malaysia, Shah Alam

Tel: +60 3 7849 0800

NZ – New Zealand, Mt Wellington

Tel: +64 9 574 1744

SG – Singapore

Tel: +65 6887 6300

TH – Thailand, Bangkok

Tel: +662 186 7000

TW – Taiwan, Taipei

Tel: +886 2 2298 8987

South America

AR – Argentina, Buenos Aires

Tel: +54 3327 44 4129

BR – Brazil, Sao Jose dos Campos

Tel: +55 800 727 5374

CL – Chile, Santiago

Tel: +56 2 623 1216

MX – Mexico, Toluca

Tel: +52 72 2275 4200

European Product Information Centre

Free phone: 00 800 27 27 5374

(from AT, BE, CH, CZ, DE, DK, EE, ES, FI,
FR, IE, IL, IS, IT, LU, MT, NL, NO, PL, PT, RU,
SE, SK, UK, ZA)

Parker Hannifin Ltd.

Tachbrook Park Drive
Tachbrook Park, Warwick CV34 6TU
United Kingdom

Tel.: +44 (0) 1926 317 878

Fax: +44 (0) 1926 317 855

parker.uk@parker.com

www.parker.com

