



aerospace
 climate control
 electromechanical
 filtration
 fluid & gas handling
 hydraulics
pneumatics
 process control
 sealing & shielding



Air Motors

P1V-S, stainless steel type - 0.02 to 1.2 kW

P1V-S, high torque type - 0.28, 0.57 & 0.86 kW

P1V-S, drilling, milling & grinding types - 0.08 to 1 kW

Catalogue PDE2554TCUK February 2015



ENGINEERING YOUR SUCCESS.

Features	Air motor	Hydraulic motor	Electric motor	Electric motor regulated	Electric motor regulated with feed back
Overload safe	***	***	*	**	***
Increased torque at higher loads	***	**	*	**	***
Easy to limit torque	***	***	*	*	***
Easy to vary speed	***	***	*	***	***
Easy to limit power	***	***	*	**	***
Reliability	***	***	***	***	***
Robustness	***	***	*	*	*
Installation cost	***	*	**	**	**
Ease of service	***	**	*	*	*
Safety in damp environments	***	***	*	*	*
Safety in explosive atmospheres	***	***	*	*	*
Safety risk with electrical installations	***	***	*	*	*
Risk of oil leak	***	*	***	***	***
Hydraulic system required	***	*	***	***	***
Weight	**	***	*	**	*
Power density	**	***	*	*	*
High torque for size	**	***	*	*	*
Noise level during operation	*	***	**	**	**
Total energy consumption	*	**	***	***	***
Service interval	*	**	***	***	***
Compressor capacity required	*	***	***	***	***
Purchase price	*	*	***	***	**
Accuracy, speed	*	**	*	**	***
Regulating dynamic	*	*	*	*	***
Communication	*	*	*	***	***

* = good, **=average, ***=excellent



Important
 Before carrying out service activities, make sure the air motor is vented. Before disassembling the motor, disconnect the primary air hose to ensure that the air supply is interrupted.



Note
 All technical data in the catalogue are typical values.
 The air quality is a major factor in the service life of the motor, see ISO 8573-1.



WARNING

FAILURE OR IMPROPER SELECTION OR IMPROPER USE OF THE PRODUCTS AND/OR SYSTEMS DESCRIBED HEREIN OR RELATED ITEMS CAN CAUSE DEATH, PERSONAL INJURY AND PROPERTY DAMAGE.

This document and other information from Parker Hannifin Corporation, its subsidiaries and authorized distributors provide product and/or system options for further investigation by users having technical expertise. It is important that you analyze all aspects of your application and review the information concerning the product or system in the current product catalog. Due to the variety of operating conditions and applications for these products or systems, the user, through its own analysis and testing, is solely responsible for making the final selection of the products and systems and assuring that all performance, safety and warning requirements of the application are met. The products described herein, including without limitation, product features, specifications, designs, availability and pricing, are subject to change by Parker Hannifin Corporation and its subsidiaries at any time without notice.

SALE CONDITIONS

The items described in this document are available for sale by Parker Hannifin Corporation, its subsidiaries or its authorized distributors. Any sale contract entered into by Parker will be governed by the provisions stated in Parker's standard terms and conditions of sale (copy available upon request).

Contents	Page
The steps to size	4
Principles of air motors	5
Introduction	6 - 8
Torque, power and air consumption graphs	9
Air quality & Lubrication	10 - 11
Stainless Steel Air Motors P1V-S	13 - 35
Stainless Steel Air Motors with brakes P1V-S	36 - 45
High Torque Stainless Steel Air Motors P1V-S	47 - 55
Mountings	56
Lubrication and service life	57
Service kits	58 - 59
Introduction to the ATEX directive	60 - 64
Drilling, Grinding & Milling Steel Air Motors P1V-S	65 - 81
Lubrication and service life	82
Service kits	82

Choosing the correct air motor for your application**① Which drive principle of the air motor is suitable for your application?**

- Air vane motor are suitable for regular operating cycles, speed is very small e.g. 16 rpm
- Tooth gear air motor or turbines are more suitable for continuous operation, 24 hours non-stop, speed is in a upper range, up to 140,000 rpm
- Oil free operation is often an option for these three principles of air motors.

② Which motor materials are suitable for your application?

- Will the air motor work in a normal production area
- Or in a paper industry
- Or in the food processing industry, in contact or not with food
- Or in underwater usage
- Or in the medical, pharmaceutical industries
- Or in potentially explosive areas
- Others, please describe your environment

③ How do you calculate the motor power taking the application conditions into consideration?

1. Which rotational direction? Clockwise, anti-clockwise, reversible?
2. Air pressure working range? Which air class quality is available?
3. Which torque and which speed under load do you expect to obtain?
4. Calculate the basic power with the formula

$$P = M \times n / 9550 \text{ with } P \text{ power output in kW, } M \text{ nominal torque in Nm, } n \text{ nominal speed in rpm}$$

5. Check performance data of air motors in our catalogues. Note that all data is at 6 bar in the inlet of the air motor, max 3 meters for tubes and oil lubricated operations.
6. To adapt the difference of air pressure with your operation conditions, please check graphs in our catalogues and how to do it.
7. or you can adapt the need of air to fit your operation conditions by throttling the outlet flow in the air motor you will reduce speed without loss of torque.
8. Check if you need an oil free or not working operation. 1 to 2 drops of oil per cube meter are needed to optimize performance and life time of air motors. Oil free operation will decrease by 10 to 15% the performance of air motors.

④ How do you integrate your air motor in your system?

- In which position is the air motor used?
- Do you need to use a brake?
- Do you want to use your own gear box and put it somewhere else in the machine?
- Do you need extra components like fittings, tubes, valves and FRLs?

⑤ How do you ensure a long life and high performance of the air motor?

- Ensure you air quality is in accordance with our specifications, oil or oil free lubrication operations.
- Keep the recommended maintenance intervals

⑥ How do you determine the purchasing and running costs after the air motor installation?

- Keep same level of your air quality.

Principles of motor functioning

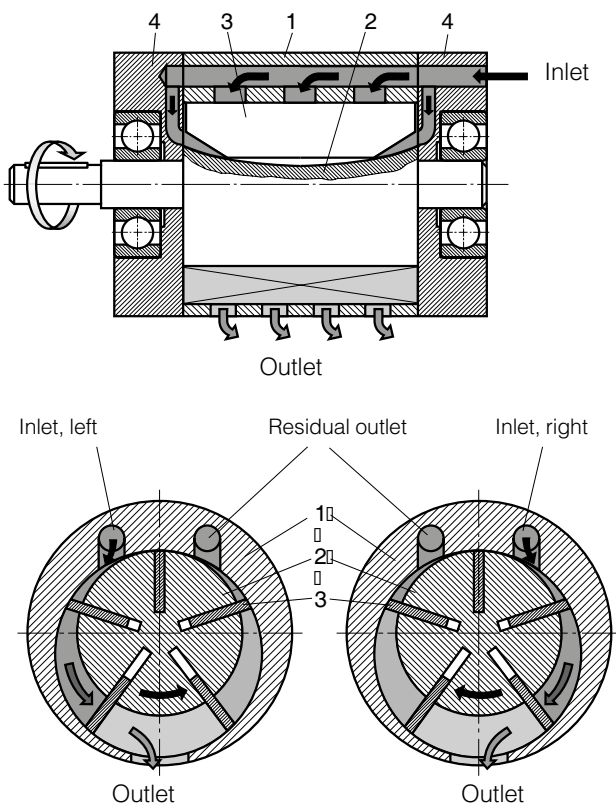

- 1 Rotor cylinder
- 2 Rotor
- 3 Vanes
- 4 End piece with bearing

There are a number of designs of air motors. Parker has chosen to use the vane rotor design, because of its simple design and reliable operation. The small external dimensions of vane motors make them suitable for all applications. The principle of the vane motor is that a rotor with a number of vanes is enclosed in a rotor cylinder. The motor is supplied with compressed air through one connection and air escapes from the other connection. To give reliable starting, the springs press the vanes against the rotor cylinder. The air pressure always bears at right angles against a surface. This means that the torque of the motor is a result of the vane surfaces and the air pressure.

Torque, power and air consumption graphs

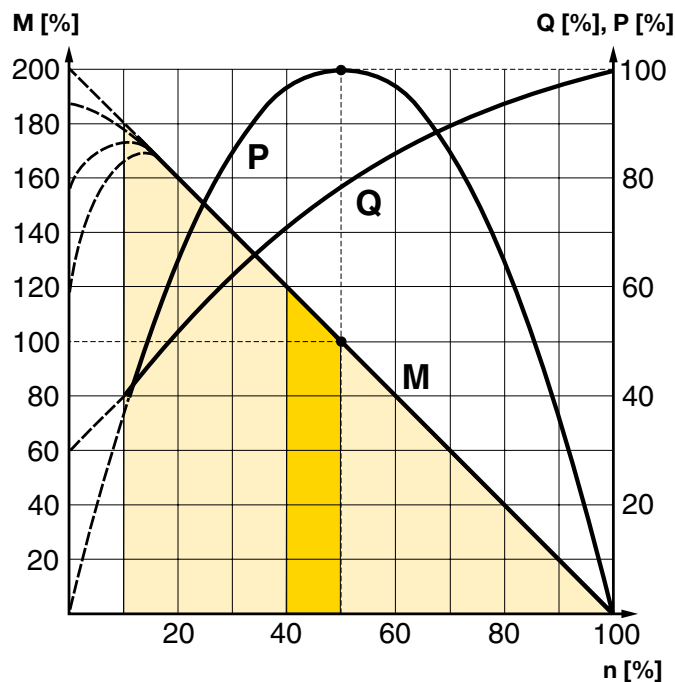

The curve is for 6 bar
P = power **Q = air consumption**
M = torque **n = speed**

- Possible working range of motor.**
- Optimum working range of motor.**
Higher speeds = more vane wear
Lower speeds with high torque = more gearbox wear

The performance characteristics of each motor are shown in a family of curves as above, from which torque, power and air consumption can be read off as a function of speed. Power is zero when the motor is stationary and also when running at free speed (100%) with no load. Maximum power (100%) is normally developed when the motor is driving a load at approximately half the free speed (50%). Torque at free speed is zero, but increases as soon as a load is applied, rising linearly until the motor stalls. As the motor can then stop with the vanes in various positions, it is not possible to specify an exact torque. However, a minimum starting torque is shown in all tables. Air consumption is greatest at free speed, and decreases with decreasing speed, as shown in the above diagram.

Introduction

The performance of an air motor is dependent on the inlet pressure. At a constant inlet pressure, air motors exhibit the characteristic linear output torque / speed relationship. However, by simply regulating the air supply, using the techniques of throttling or pressure regulation, the output of an air motor can easily be modified. The most economical operation of an air motor (least wear, least air consumption, etc.) is reached by running close to nominal speed. By torque of $M = 0$, the maximum speed (idle speed) is reached. Shortly before standstill ($n = 0$), the air motor reaches its maximum torque ($M_{max} = 2 \times M_o$). At nominal speed (n_n), for example in the middle of the speed range, air motor reaches its maximum power output (P_{max}).

Energy Efficiency

A pneumatic motor achieves its maximum power when it is operating as close as possible to its rated speed (50% of the rated idle speed). The energy balance is best in this area, because the compressed air is used efficiently.

Air pressure correction factors

To adapt the difference of air pressure with your operation conditions

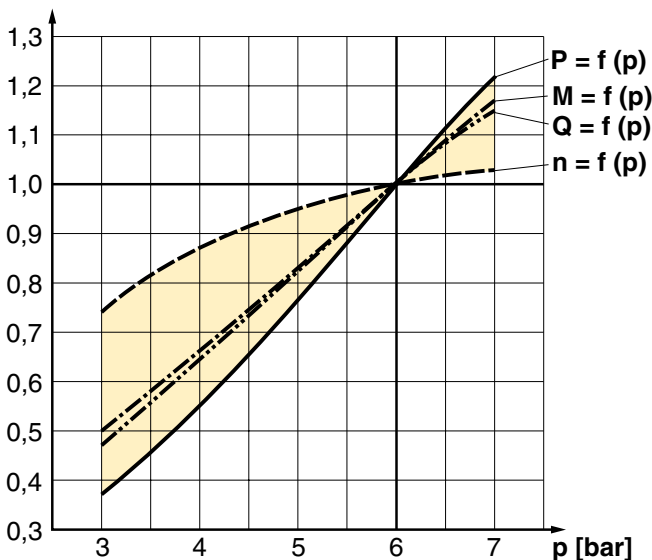

P = Power, M = Torque, Q = Air consumption, N = Speed

Pressure (p) bar / PSI	Power (P) %	Speed (n) %	Torque (M) %	Air Consumpt. (Q) %
7 / 99	121	103	117	117
6 / 85	100	100	100	100
5 / 71	77	95	83	83
4 / 57	55	87	67	67
3 / 42	37	74	50	50

All catalogue data and curves are specified at a supply pressure of 6 bar to the motor. This diagram shows the effect of pressure on speed, specified torque, power and air consumption. Start off on the curve at the pressure used and then look up to the lines for power, torque and air consumption. Read off the correction factor on the Y axis for each curve and multiply this by the specified catalogue data in the table, or data read from the torque and power graphs.

Example: at 4 bar supply pressure, the power is only 0.55 x power at 6 bar supply pressure. This example shows how strongly power falls if supply pressure is reduced. You must therefore ensure that the motor is supplied through pipes of sufficient diameter to avoid pressure drop.

The speed and torque can also be regulated by installing a pressure regulator in the inlet pipe. This means that the motor is constantly supplied with air at lower pressure, which means that when the motor is braked, it develops a lower torque on the output shaft.

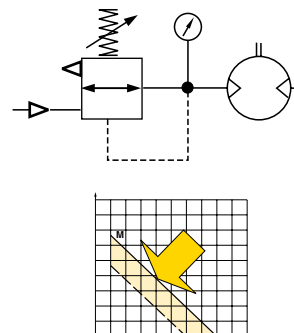

Pressure regulation at motor inlet.

Theoretically torque curve change caused by pressure change

Speed regulation, air flow reduction

Every size reduction or restriction on the air line, whether of the supply hose itself or fittings, before the air motor affects the amount of the supplied air. By throttling you reduce the speed of your motor and simultaneously, the required torque. That means that you reduce the motor performance. The most common way to reduce the speed of a motor is to install a flow control valve in the air outlet, you can set the speed without loss of the torque. When the motor is used in applications where it must reverse and it is necessary to restrict the speed in both directions, flow control valves with by-pass should be used in both directions. If the inlet air is restricted, the air supply is restricted and the free speed of the motor falls, but there is full pressure on the vanes at low speeds. This means that we get full torque from the motor at low speeds despite the low air flow. Since the torque curve becomes "steeper", this also means that we get a lower torque at any given speed than would be developed at full air flow. The benefit of throttling the inlet is that air consumption is reduced, whereas throttling the exhaust air maintains a slightly higher starting torque.

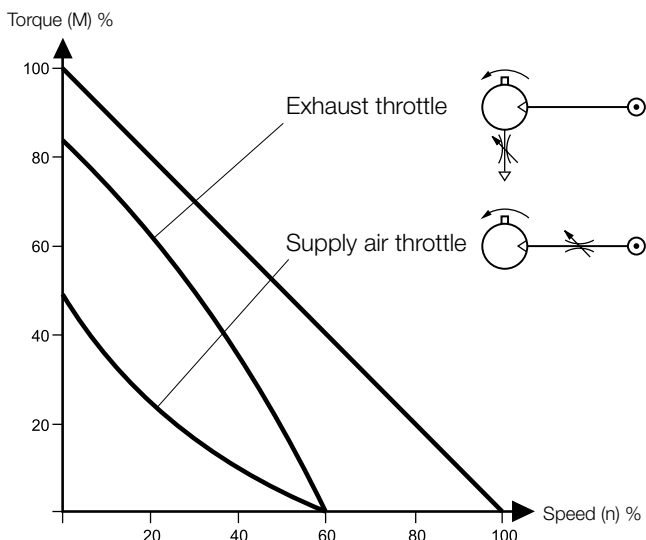

Throttling

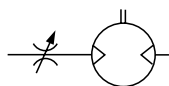

Supply or exhaust throttling, non-reversible motor

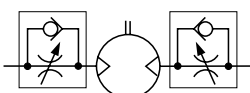

Supply throttling, reversible motor

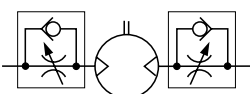

Exhaust throttling, reversible motor

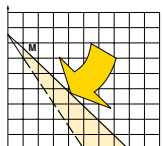

Theoretically torque curve change caused by throttling

Component choice for air supply

Direction of motor rotation

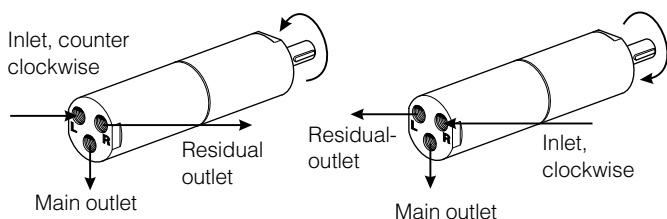

The direction of rotation of reversible motors is controlled by supplying inlet L or inlet R with compressed air. Air motors can be stopped and started continually without damage.

As the motor begins to rotate air is trapped between the vanes and is compressed. This air is exhausted through the exhaust port. As the rotor continues its rotation, trapped air is compressed and exhausted through the residual port. If this air is not exhausted, the motor will be braked and maximum power will not be obtained.

Compressed air quality

Oil and oil mist are avoided whenever possible to ensure a clean work environment. In addition, purchasing, installation and maintenance of oil equipment can be expensive. All users in all industries now try to avoid using components which have to be lubricated. The P1V air motors series are equipped with vanes for intermittent lubrication free operation as standard, which is the most common application of air motors.

Dry unlubricated compressed air



If unlubricated compressed air is used, the compressed air should comply with the purity standards below in order to guarantee the longest possible overall service life. If the unlubricated compressed air has a high water content, condensation forms inside the motor, causing corrosion in all internal components. A ball bearing can be destroyed in a remarkably short time if it comes into contact with a single water droplet. For indoor use, we recommend ISO8573-1 purity class 3.4.1. To achieve this, compressors must be fitted with after coolers, oil filters, refrigerant air dryers and air filters. For indoor/outdoor use, we recommend ISO8573-1 purity class 1.2.1. To achieve this, compressors must be fitted with after coolers, oil filters, adsorption dryers and dust filters.

Oil mist



If oil mist is used (approx. 1 drop of oil per m³ of compressed air), the oil not only acts as a lubricant but also protects against corrosion. This means that compressed air with a certain water content may be used without causing corrosion problems inside the motor. ISO8573-1 purity class 3.-.5 may be used without difficulty. The following oils are recommended for use in the food stuffs industry: Shell Cassida Fluid HF 32 or Klüberoil 4 UH 1-32

ISO 8573-1 purity classes

Quality class	Contaminants		Water	Oil
	particle size (µm)	max. concentration (mg/m ³)	max. pressure dew point (°C)	max. concentration (mg.m ³)
1	0.1	0.1	-70	0.01
2	1	1	-40	0.1
3	5	5	-20	1.0
4	15	8	+3	5.0
5	40	10	+7	25
6	-	-	+10	-

For example: compressed air to purity class 3.4.3. This means a 5 µm filter (standard filter), dew point +3°C (refrigerant cooled) and an oil concentration of 1,0 mg oil/m³ (as supplied by a standard compressor with a standard filter).

Air supply

Since the supply pressure at the air motor inlet port is of considerable importance for obtaining the power, speed and torque quoted in the catalogue, the recommendations below should be observed.

The following data must be complied with:

- Supply pressure: 7 bar
- Regulator pressure setting: 6.7 bar
- Pipe length between air treatment unit and valve: max. 1 m
- Pipe length valve and air motor: max 2 m

The pressure drop through the air preparation unit, pipe, valve means that 6 bar pressure is obtained at the motor supply port. Please refer to the correction diagram and factors to see what lower supply pressure means for power, speed and torque.

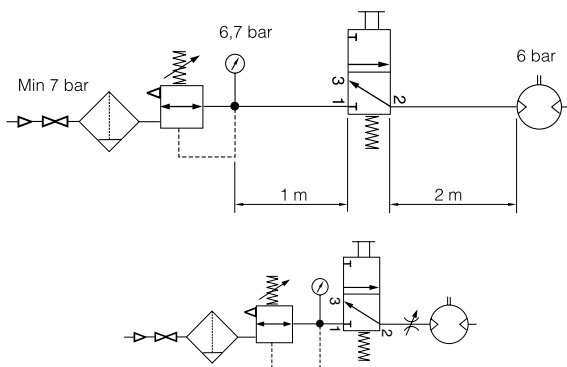

Shut-off, filtering, pressure regulation and control valve

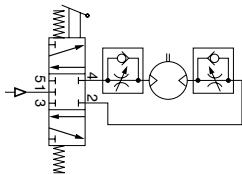

Reversible motor with 5/3 control valve

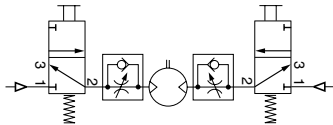

Reversible motor with two 3/2 control valves

The air with which the motor is supplied must be filtered and regulated. Directional valves are needed to provide it with air, to get the motor to rotate when we want it to. These valves can be equipped with several means of actuation, such as electric, manual and pneumatic control. When the motor is used in a non-reversible application, it is sufficient to use a 2/2 or 3/2 valve function for supply. Either one 5/3 or two 3/2 valves functions are needed for a reversible motor, to ensure that the motor receives compressed air and the residual air outlet is vented. A flow control valve can be installed in the supply pipe to regulate the motor speed if the motor is not used as a reversible motor.

One flow control valve with by-pass is needed to regulate each direction of rotation if the motor is used as a reversible motor. The built-in check valve will then allow air from the residual air outlet to escape through the outlet port in the control valve. The compressed air supply must have sufficiently large pipes and valves to give the motor the maximum power. The motor needs 6 bar at the supply port all the time. For example, a reduction of pressure to 5 bar reduces the power developed to 77% and to 55% at 4 bar!

Silencing

Exhaust silencer

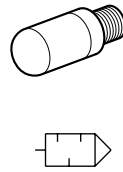

Central silencer

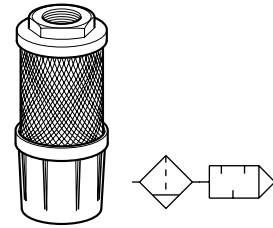

The noise from an air motor consists of both mechanical noise and a pulsating noise from the air flowing out of the outlet. The installation of the motor has a considerable effect on mechanical noise. It should be installed so that no mechanical resonance effects can occur. The outlet air creates a noise level which can amount to 115 dB(A) if the air is allowed to exhaust freely into the atmosphere. Various types of exhaust silencers are used to reduce this level. The most common type screws directly onto the exhaust port of the motor. Since the motor function causes the exhaust air to pulsate, it is a good idea to allow the air to exhaust into some kind of chamber first, which reduces the pulsations before they reach the silencer. The best silencing method is to connect a soft plastic hose to a large central silencer with the largest possible area, to reduce the speed of the out-flowing air as far as possible.

NOTE! Remember that if a silencer which is too small or is blocked, generates back pressure on the outlet side of the motor, which reduces the motor power.

CE marking

The air motors are supplied as “Components for installation” – the installer is responsible for ensuring that the motors are installed safely in the overall system. Parker Pneumatic guarantees that its products are safe, and as a supplier of pneumatic equipment we ensure that the equipment is designed and manufactured in accordance with the applicable EU directive.

Most of our products are classed as components as defined by various directives, and although we guarantee that the components satisfy the fundamental safety requirements of the directives to the extent that they are our responsibility, they do not usually carry the CE mark. Nevertheless, most P1V-S motors carry the CE mark because they are ATEX certified (for use in explosive atmospheres).

The following are the currently applicable directives:

- Machinery Directive (essential health and safety requirements relating to the design and structure of machines and safety components)
- EMC Directive
- Simple Pressure Vessels Directive
- Low Voltage Directive
- ATEX Directive (ATEX = ATmosphere EXplosive)

Torque, power and air consumption graphs

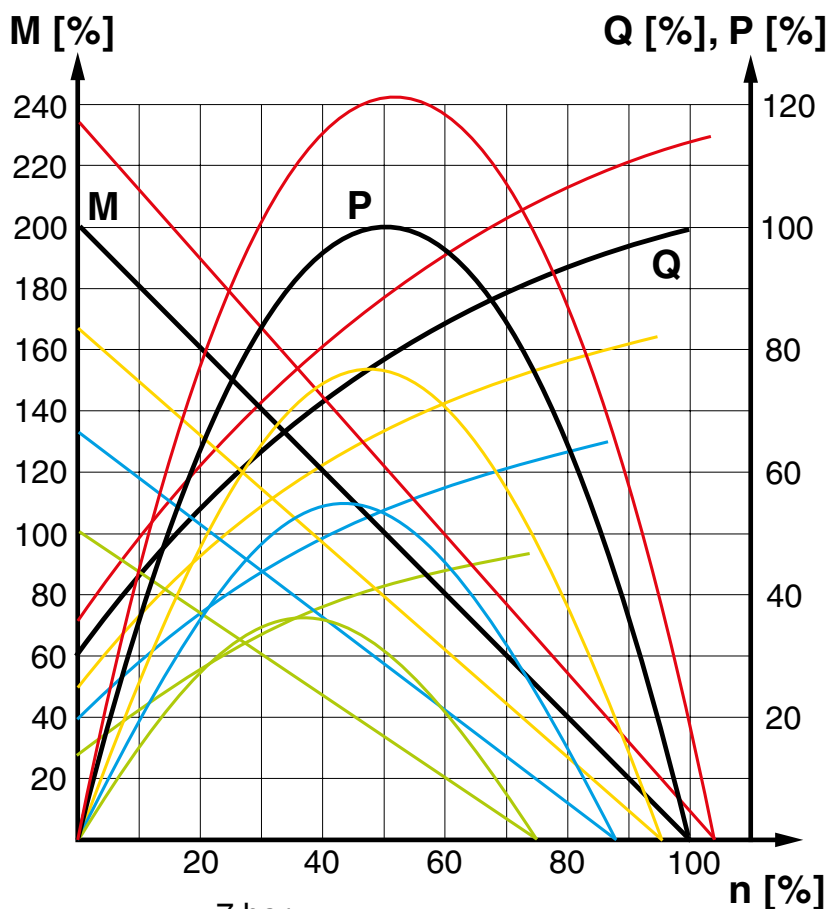

- 7 bar
- 6 bar
- 5 bar
- 4 bar
- 3 bar

P = power	Q = air consumption
M = torque	n = speed

The curves in this graph are a combination of the torque, power and air consumption graphs. The values from the correction diagram have also been used for the curves for the different pressure values. The graph also shows that it is very important to ensure that the pressure supplied to the inlet port of the motor is correct, in order to allow the motor to work at maximum capacity. If the valve supplying a large motor is too small or if the supply line is underspecified, the pressure at the inlet port may be so low that the motor is unable to do its work. One solution would be to upgrade the valve and supply system, or alternatively you could replace the motor with a smaller motor with lower air consumption. The result would be increased pressure at the inlet port, which means that the smaller motor could carry out the necessary work. However, you may need to select a smaller motor with a lower free speed in order to obtain sufficient torque at the outgoing shaft.

Choice of an air motor, general

The motor to be used should be selected by starting with the torque needed at a specific spindle speed. In other words, to choose the right motor, you have to know the required speed and torque. Since maximum power is reached at half the motor's free speed, the motor should be chosen so that the point aimed at is as close as possible to the maximum power of the motor.

The design principle of the motor means that higher torque is generated when it is braked, which tends to increase the speed. This means that the motor has a kind of speed selfregulation function built in. Use the following graph to choose the correct motor size and the correct type of gear as appropriate. The graph contains the points for the maximum torque of each motor at maximum power. Put in your point on the graph and select a marked point above and to the right of the point you need.

Then check the characteristic graph of each motor to find more accurate technical data. Always select a motor where the data required is in the orange field. Also use the correction diagram to see what it would mean to use different air supply pressures or different air flow in the motor.

Tip: Select a motor which is slightly too fast and powerful, regulate its speed and torque with a pressure regulator and/or restriction to achieve the optimum working point.

Do you need any support to select the right air motor, please feel free to consult your local sales office.

Specifying air quality (purity) in accordance with ISO8573-1:2010, the international standard for Compressed Air Quality

ISO8573-1 is the primary document used from the ISO8573 series as it is this document which specifies the amount of contamination allowed in each cubic metre of compressed air.

ISO8573-1 lists the main contaminants as Solid Particulate, Water and Oil. The purity levels for each contaminant are shown separately in tabular form, however for ease of use, this document combines all three contaminants into one easy to use table.

ISO8573-1:2010 CLASS	Solid Particulate			Mass Concentration mg/m ³	Water		Oil
	Maximum number of particles per m ³				Vapour Pressure Dewpoint	Liquid g/m ³	Total Oil (aerosol liquid and vapour) mg/m ³
	0,1 - 0,5 micron	0,5 - 1 micron	1 - 5 micron				
0	As specified by the equipment user or supplier and more stringent than Class 1						
1	≤ 20 000	≤ 400	≤ 10	-	≤ -70 °C	-	0,01
2	≤ 400 000	≤ 6 000	≤ 100	-	≤ -40 °C	-	0,1
3	-	≤ 90 000	≤ 1 000	-	≤ -20 °C	-	1
4	-	-	≤ 10 000	-	≤ +3 °C	-	5
5	-	-	≤ 100 000	-	≤ +7 °C	-	-
6	-	-	-	≤ 5	≤ +10 °C	-	-
7	-	-	-	5 - 10	-	≤ 0,5	-
8	-	-	-	-	-	0,5 - 5	-
9	-	-	-	-	-	5 - 10	-
X	-	-	-	> 10	-	> 10	> 10

Specifying air purity in accordance with ISO8573-1:2010

When specifying the purity of air required, the standard must always be referenced, followed by the purity class selected for each contaminant (a different purity class can be selected for each contamination if required).

An example of how to write an air quality specification is shown below:

ISO 8573-1:2010 Class 1.2.1

ISO 8573-1:2010 refers to the standard document and its revision, the three digits refer to the purity classifications selected for solid particulate, water and total oil. Selecting an air purity class of 1.2.1 would specify the following air quality when operating at the standard's reference conditions :

Class 1 - Particulate

In each cubic metre of compressed air, the particulate count should not exceed 20,000 particles in the 0.1 - 0.5 micron size range, 400 particles in the 0.5 - 1 micron size range and 10 particles in the 1 - 5 micron size range.

Class 2 - Water

A pressure dewpoint (PDP) of -40°C or better is required and no liquid water is allowed.

Class 1 - Oil

In each cubic metre of compressed air, not more than 0.01mg of oil is allowed. This is a total level for liquid oil, oil aerosol and oil vapour.

ISO8573-1:2010 Class zero

- Class 0 does not mean zero contamination.
- Class 0 requires the user and the equipment manufacturer to agree contamination levels as part of a written specification.
- The agreed contamination levels for a Class 0 specification should be within the measurement capabilities of the test equipment and test methods shown in ISO8573 Pt 2 to Pt 9.
- The agreed Class 0 specification must be written on all documentation to be in accordance with the standard.
- Stating Class 0 without the agreed specification is meaningless and not in accordance with the standard.
- A number of compressor manufacturers claim that the delivered air from their oil-free compressors is in compliance with Class 0.
- If the compressor was tested in clean room conditions, the contamination detected at the outlet will be minimal. Should the same compressor now be installed in typical urban environment, the level of contamination will be dependent upon what is drawn into the compressor intake, rendering the Class 0 claim invalid.
- A compressor delivering air to Class 0 will still require purification equipment in both the compressor room and at the point of use for the Class 0 purity to be maintained at the application.
- Air for critical applications such as breathing, medical, food, etc typically only requires air quality to Class 2.2.1 or Class 2.1.1.
- Purification of air to meet a Class 0 specification is only cost effective if carried out at the point of use.

New Technology

The P3X Lite air preparation system is constructed from ultra light weight technopolymers instead of the traditional aluminium or zinc die cast, this means that is up to 45% lighter than conventional units.

This non-metal construction also means that the P3X Lite is corrosion free enabling it to be used in harsh industrial environments where anti freeze or aggressive synthetic oils are present.

The use of technopolymers in the design of P3X Lite has facilitated a universal body design, this has resulted in reducing the number of variants required to cover the full spectrum of applications. This can dramatically lower logistic costs and simplify stock holding for customers making the P3X Lite a very cost effective solution.



New Nano Mist Technology, New Lubricator Concept. Self-Adjusting.

With conventional lubricators, only the oil volume per time unit can be adjusted. If the demand changes, the quantity dispensed still remains constant.

The P3X Lite lubricator concept sets new benchmarks here. For the first time, the oil volume is automatically adjusted to the flow rate. This ensures that there is neither too little nor too much oil in the system, which leads to clear economic and ecological advantages. In addition, with conventional systems, the distance between the lubricator and the equipment has to be less than 8 meters. With larger distances, the dispensed oil is deposited as a wall flow. The new lubricator principle of the P3X Lite allows for distances of up to 40 meters. This opens up new scope for the design of even more efficient production systems.





Air Motors

P1V-S, Stainless Steel Type
20 to 1200 Watts

Contents	Page
Stainless Steel Air Motors P1V-S	15
Choice of air motor	16
Overview	17
Technical data	18
Material specification	18
Permitted shaft loadings	19
Order key	20
Choice of vanes	20
Reversible air motor 20 watts	21
Torque and power graphs	21
Dimensions	21
Reversible air motor right direction 30 watts	22
Torque and power graphs	22
Dimensions	22
Reversible air motor 80 watts	23
Torque and power graphs	23
Dimensions	23
Reversible air motor 120 watts	24
Torque and power graphs	24
Dimensions	25
Reversible air motor 200 watts	26
Torque and power graphs	26
Dimensions	27
Reversible air motor 300 watts	28
Torque and power graphs	28
Dimensions	29
Reversible air motor 600 watts	30
Torque and power graphs	30
Dimensions	31
Reversible air motor 900 watts	32
Torque and power graphs	32
Dimensions	33
Reversible air motor 1200 watts	34
Torque and power graphs	34
Dimensions	35
Stainless Steel Air Motors with brakes P1V-S	36 - 45
High Torque Stainless Steel Air Motors P1V-S	47 - 55
Mountings	56
Lubrication and service life	57
Service kits	58 - 59
Introduction to the ATEX directive	60 - 64

P1V-S - Stainless Steel Air Motors

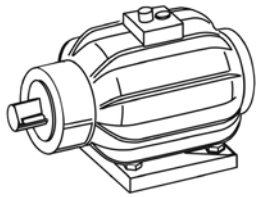

Air motors have much smaller installation dimensions than corresponding electric motors.



Air motors can be loaded until they stall, without damage. They are designed to be able to withstand the toughest heat, vibration, impact etc.



The weight of an air motor is several times less than corresponding electric motors.

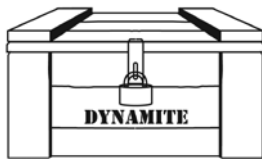

Air motors can be used in the harshest environments. Most P1V-S motors are ATEX certified.



The choice of materials means that they can be used in damp and aggressive environments.



The shape, design and non-lubricated operation allow the motor to be suitable for use in the food industry.



Air motors can be stopped and started continually without damage.

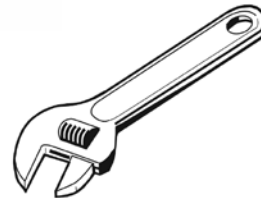

The simple design principle of air motors makes them very easy to service.

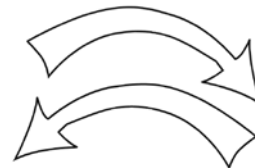

The motors are reversible as standard.



The reliability of air motors is very high, thanks to the design and the low number of moving parts.

P1V-S - Stainless Steel Air Motors

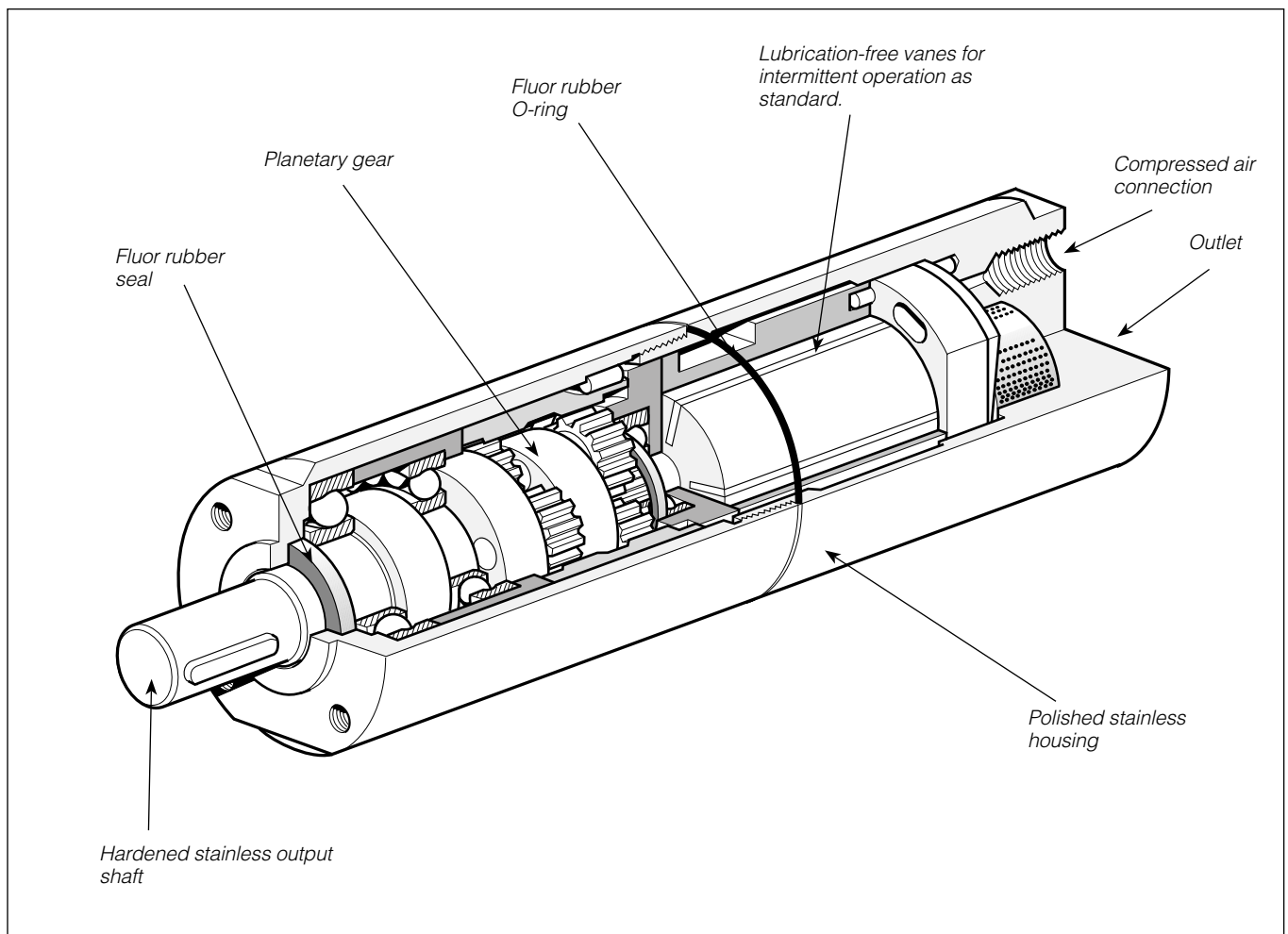

Stainless Steel Air Motors

P1V-S is a range of air motors with all external components made of stainless steel, which means that they can be used in food grade applications, and in all other applications where there is a risk of corrosion.

The range contains seven different sizes, with powers ranging from 20 to 1 200 Watts, and speeds from 5 to 24 000 rpm. The air motor and planetary reduction gear are built into a polished stainless steel housing, which is sealed by a fluor rubber O-ring. The output shaft, which is made of polished stainless steel, is also sealed by a fluor rubber seal.

Consideration for achieving a clean, hygienic design was given early on in the development of this range of air motors. Thanks to the cylindrical shape, there are no pockets which can accumulate dirt or bacteria. Additionally, the two halves of the motor body are sealed

with an o-ring to prevent contamination. The choice of materials reflects the fact that aggressive cleaning materials are used in food grade applications.

The P1V-S series is designed to be operated in intermittent intervals under non-lubrication conditions. For this reason, no particles of lubricant escape with the exhaust air and the service costs are reduced. This means that the motors can be used directly in food grade applications. The planetary gear, which has one or more reduction stages, is lubricated with an USDA-H1 standard grease, approved for use in food grade applications.

Choice of an air motor

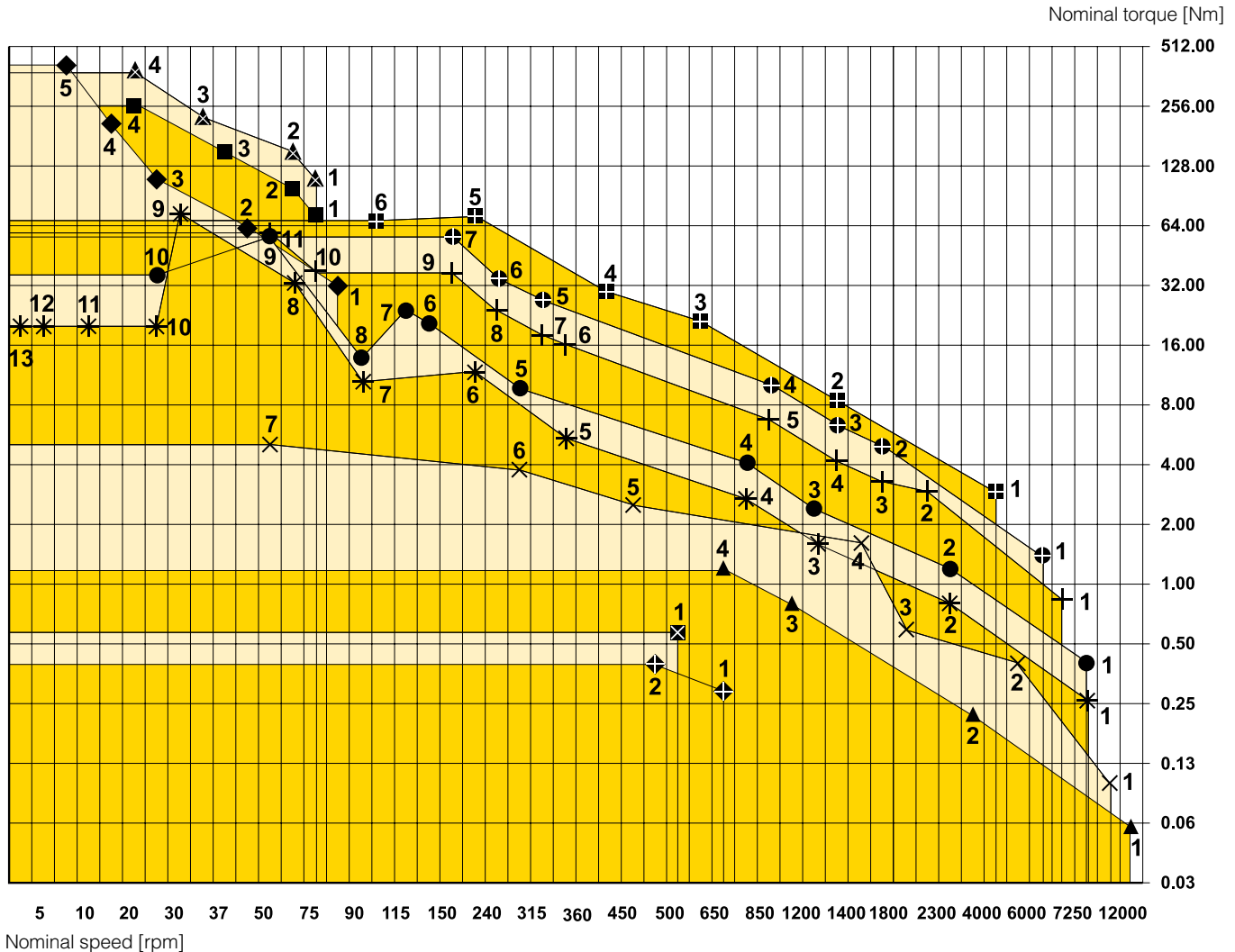

The motor to be used should be selected by starting with the torque needed at a specific shaft speed. In other words, to choose the right motor, you have to know the required speed and torque. Since maximum power is reached at half the motor's free speed, the motor should be chosen so that the operating point is as close as possible to the maximum power of the motor.

The design principle of the motor means that higher torque is generated when it is braked, which tends to increase the speed, etc. This means that the motor has a kind of speed self-regulation function built in.

Use the above graph to choose the correct motor size. The graph contains the points for the maximum torque of each motor at maximum output. Add your operating point to the graph, then select a marked point above and to the right of your point.

Then use the correct working diagram of the chosen motor to get more detailed technical data. Always select a motor whose requisite technical data are in the shaded area. Also use the correction diagram to find out what operation with different supply pressures would mean for the motor.

Tip: Select a motor which is slightly too fast and powerful, then regulate its speed and torque with a pressure regulator and/or throttle to achieve the optimum working point.

- ↔ P1V-S002
- ⊗ P1V-S003
- ▲ P1V-S008
- × P1V-S012
- * P1V-S020
- P1V-S030
- ⊕ P1V-S060
- ⊕ P1V-S090
- ⊕ P1V-S120
- ◆ P1V-S028 HT
- P1V-S057 HT
- ▲ P1V-S086 HT

P1V-S - Stainless Steel Air Motors

- ↔ 1 P1V-S002A0130
- ↔ 2 P1V-S002A0095

20 Watt



P1V-S002A

- ⊗ 1 P1V-S003B0100

30 Watt



P1V-S003A

- ▲ 1 P1V-S008A0Q00
- ▲ 2 P1V-S008A0700
- ▲ 3 P1V-S008A0190
- ▲ 4 P1V-S008A0130

80 Watt



P1V-S008A

- ✕ 1 P1V-S012A0N00, P1V-S012D0N00
- ✕ 2 P1V-S012A0550, P1V-S012D0550
- ✕ 3 P1V-S012A0360, P1V-S012D0360
- ✕ 4 P1V-S012A0140, P1V-S012D0140
- ✕ 5 P1V-S012A0090, P1V-S012D0090
- ✕ 6 P1V-S012A0060, P1V-S012D0060
- ✕ 7 P1V-S012A0010, P1V-S012D0010

120 Watt



P1V-S012

- * 1 P1V-S020A0E50, P1V-S020D0E50
- * 2 P1V-S020A0460, P1V-S020D0460
- * 3 P1V-S020A0240, P1V-S020D0240
- * 4 P1V-S020A0140, P1V-S020D0140
- * 5 P1V-S020A0070, P1V-S020D0070
- * 6 P1V-S020A0032, P1V-S020D0032
- * 7 P1V-S020A0018, P1V-S020D0018
- * 10 P1V-S020A0005, P1V-S020D0005
- * 11 P1V-S020A0002
- * 12 P1V-S020A0001
- * 13 P1V-S020A00005

200 Watt



P1V-S020

- 1 P1V-S030A0E50, P1V-S030D0E50
- 2 P1V-S030A0460, P1V-S030D0460
- 3 P1V-S030A0240, P1V-S030D0240
- 4 P1V-S030A0140, P1V-S030D0140
- 5 P1V-S030A0060, P1V-S030D0060
- 6 P1V-S030A0034, P1V-S030D0034
- 7 P1V-S030A0023
- 8 P1V-S030A0018, P1V-S030D0018
- 9 P1V-S030A0010
- 10 P1V-S030A0005, P1V-S030D0005

High torque

- ◆ 1 P1V-S028A0017
- ◆ 2 P1V-S028A0008
- ◆ 3 P1V-S028A0005
- ◆ 4 P1V-S028A0003
- ◆ 5 P1V-S028A0002

300 Watt



P1V-S030

- + 1 P1V-S060A0E00
- + 2 P1V-S060A0350
- + 3 P1V-S060A0270
- + 4 P1V-S060A0170
- + 5 P1V-S060A0063
- + 6 P1V-S060A0048
- + 7 P1V-S060A0030
- + 8 P1V-S060A0015

- 1 P1V-S057A0015
- 2 P1V-S057A0011
- 3 P1V-S057A0007
- 4 P1V-S057A0004

600 Watt



P1V-S060A

- ⊕ 1 P1V-S090A0C00
- ⊕ 2 P1V-S090A0350
- ⊕ 3 P1V-S090A0270
- ⊕ 4 P1V-S090A0170
- ⊕ 5 P1V-S060A0063
- ⊕ 6 P1V-S060A0048
- ⊕ 7 P1V-S060A0030

- ▲ 1 P1V-S086A0015
- ▲ 2 P1V-S086A0011
- ▲ 3 P1V-S086A0007
- ▲ 4 P1V-S086A0004

900 Watt



P1V-S090A

- 1 P1V-S120A0900
- 2 P1V-S120A0250
- 3 P1V-S120A0110
- 4 P1V-S120A0070
- 5 P1V-S120A0032
- 6 P1V-S120A0020

1200 Watt



P1V-S120A

P1V-S - Stainless Steel Air Motors

Technical data

Air motor size & type	P1V-S002	P1V-S003	P1V-S008	P1V-S012	P1V-S020	P1V-S030	P1V-S060	P1V-S090	P1V-S120
Nominal power (watts)	20	30	80	120	200	300	600	900	1200
Working pressure (bar)	3 to 7, 6 in explosive atmosphere								
Working temperature (°C)	-20 to +110								
Ambient temperature (°C)	-20 to +40 in explosive atmosphere								
Air flow required (NI/min)	100	100	230	300	370	470	850	1400	1600
Min pipe ID, inlet (mm)	3	3	4	6	10	10	12	12	19
Min pipe ID, outlet (mm)	3	3	4	6	10	10	12	12	19

Choice of treatment unit: recommended min air flow (l/min) at p1 7.5 bar and 0.8 bar pressure drop

	120	120	260	340	410	510	900	1500	1800
Medium	40µm filtered, oil mist or dry unlubricated compressed air								
Oil free operation, indoor	ISO8573-1 purity class 3.4.1								
Oil free operation, outdoor	ISO8573-1 purity class 1.2.1								
Oil operation	1-2 drop per cube meter, ISO8573-1 purity class 3.-.5								
Recommended oil	Foodstuffs industry Klüber oil 4 UH1- 32 N								

Choice of valve: recommended min nominal air flow (l/min) at p1 6 bar and 1 bar pressure drop

	140	140	290	380	450	550	950	1600	2000
Sound level free outlet (dB(A))	98	98	95	99	100	103	103	106	108
With outlet silencer (dB(A))	85	85	85	92	82	91	94	88	95
Exhaust air removed with pipes to another room	74	74	71	70	71	70	76	80	87

Note: sound levels are measured at free speed with the measuring instrument positioned 1 meter away from the air motor at an height of 1 meter.

Table and diagram data

All technical data are based on a working pressure of 6 bar and with oil. Oil-free performances are -10 to 15% lower. Data tolerance accuracy +-10%

Material specification

Air motor size & type	P1V-S002	P1V-S003	P1V-S008	P1V-S012	P1V-S020	P1V-S030	P1V-S060	P1V-S090	P1V-S120
Planetary gearbox housing	Stainless steel								
Planetary gearbox housing for last planet stage including installation flange	-	-	-	-		Black oxidised steel (not stainless)	-	-	-
Air motor housing	Stainless steel								
Shaft	Hardened stainless steel								
Key	Hardened stainless steel								
External seal Fluor rubber	Fluor rubber FPM								
Internal steel parts	High grade steel (not stainless)								
Planetary gear grease used in	Grease, Shell Cassida RLS2								
Screws in housing in last planet stage	Surface treated steel (not stainless)								

Accessories	P1V
Flange bracket	Stainless steel
Foot bracket	Stainless steel
Screws for the mountings	Stainless steel DIN A2

P1V-S - Stainless Steel Air Motors

Permitted shaft loadings

Max. permitted load on output shaft for motors (based on 10 000 000 rpm at input shaft with 90 % probable service life for ball bearings).

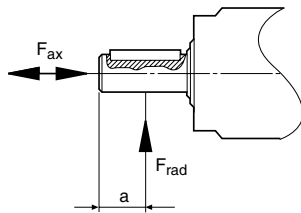

Fig. 1: Load on output shaft for basic motor with keyed shaft.

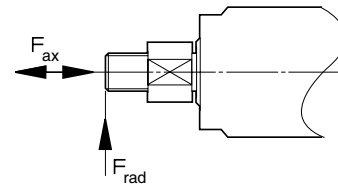

Fig. 2: Load on output shaft for basic motor with threaded shaft.

Motor with keyed shaft

Order code	Fax [N]	Frad [N]	a [mm]
P1V-S002A0130	140	180	6
P1V-S002A0095	140	180	6
P1V-S003B0100	140	180	6
P1V-S008A0Q00	200	220	7
P1V-S008A0700	200	220	7
P1V-S008A0190	200	220	7
P1V-S008A0130	200	220	7
P1V-S012AN00	380	160	9
P1V-S012A550	380	160	9
P1V-S012A360	380	160	9
P1V-S012A140	380	160	9
P1V-S012A090	380	160	9
P1V-S012A060	380	160	9
P1V-S012A010	380	160	9
P1V-S020A0E50	570	720	12
P1V-S020A0460	570	720	12
P1V-S020A0240	570	720	12
P1V-S020A0140	570	720	12
P1V-S020A0070	570	720	12
P1V-S020A0032	570	720	12
P1V-S020A0018	570	720	12
P1V-S020A0005	570	720	12
P1V-S020A0002	570	720	12
P1V-S020A0001	570	720	12
P1V-S020A00005	570	720	12
P1V-S030A0E50	570	1130	14
P1V-S030A0460	570	1130	14
P1V-S030A0240	570	1130	14
P1V-S030A0140	570	1130	14
P1V-S030A0060	790	1070	15
P1V-S030A0034	790	1070	15
P1V-S030A0023	790	1070	15
P1V-S030A0018	790	1070	15
P1V-S030A0010	790	1070	15
P1V-S030A0005	790	1070	15
P1V-S060A0E00	1110	1300	15
P1V-S060A0350	1110	1300	15
P1V-S060A0270	1110	1300	15
P1V-S060A0170	1110	1300	15
P1V-S060A0063	1110	1300	15
P1V-S060A0048	1130	2090	18
P1V-S060A0030	1130	2090	18
P1V-S060A0015	1130	2090	18
P1V-S120A0900	2330	2260	18
P1V-S120A0250	2330	2260	18
P1V-S120A0110	2330	2260	18
P1V-S120A0070	2330	2700	30
P1V-S120A0032	2330	2700	30
P1V-S120A0020	2330	2700	30
P1V-S028A0017	1500	3500	21
P1V-S028A0008	1500	3500	21
P1V-S028A0005	1500	3500	21
P1V-S028A0003	1500	3500	20
P1V-S028A0002	1500	3500	20
P1V-S057A0015	1500	3500	21
P1V-S057A0011	1500	3500	21
P1V-S057A0007	1500	3500	21
P1V-S057A0004	1500	3500	22.5
P1V-S086A0015	1500	3500	21
P1V-S086A0011	1500	3500	21
P1V-S086A0007	1500	3500	21
P1V-S086A0004	1500	3500	22.5

Motor with threaded shaft

Order code	Fax [N]	Frad [N]	a [mm]
P1V-S012DN00	380	110	0
P1V-S012D550	380	110	0
P1V-S012D360	380	110	0
P1V-S012D140	380	110	0
P1V-S012D090	380	110	0
P1V-S012D060	380	110	0
P1V-S012D010	380	110	0
P1V-S020D0E50	570	450	0
P1V-S020D0460	570	450	0
P1V-S020D0240	570	450	0
P1V-S020D0140	570	450	0
P1V-S020D0070	570	450	0
P1V-S020D0032	570	450	0
P1V-S020D0018	570	450	0
P1V-S020D0005	570	450	0
P1V-S030D0E50	570	860	0
P1V-S030D0460	570	860	0
P1V-S030D0240	570	860	0
P1V-S030D0140	570	860	0
P1V-S030D0060	790	820	0
P1V-S030D0034	790	820	0
P1V-S030D0018	790	820	0
P1V-S030D0005	790	820	0

Frad = Radial loading (N)
 Fax = Axial loading (N)
 a = distance from shaft's end (mm)

P1V-S - Stainless Steel Air Motors

Order key

(This model code can not be used for creating new part numbers except for optional function. All possible combinations between motor size, function and free speed are in the next pages).

P
1
V
-
S

0
2
0

A

0

E
5
0

Motor size		Function		Optional function		Free speed per min	
002	20 W	A	Keyed or flattened shaft	0	Standard vanes	0005	5
003	30 W	B	Keyed or flattened shaft right rotation	C	Continuous lubrication-free operation	001 999	10 9990
008	80 W	D	Threaded shaft	Z*	Standard spring loaded vanes	A00 E00 E50	10000 14000 14500
012	120 W			M*	Cont. spring loaded vanes	N00 Q00	22000 24000
020	200 W			D**	Standard with brake		
028	285 W High torque			E**	Option C with brake		
030	300 W			F**	Option Z with brake		
057	570 W High torque			G**	Option M with brake		
060	600 W						
086	860 W High torque						
090	900 W						
120	1200 W						

Air motor range	
P1V-S	Stainless steel motor

* Not for P1V-S002, P1V-S003 and P1V-S008

** Only for P1V-S020, P1V-S030 and P1V-S120

Choice of vanes

0 = Standard vanes	C = Vanes for continuous lubrication-free operation	Z = Standard spring loaded vanes	M = Spring loaded vanes for continuous lubrication-free operation
<p>These motors are of the vane type for intermittent lubrication-free operation. They can operate 70% of the time for up to 15 minutes without lubrication. With lubrication, these motors can operation 100% of the time.</p>	<p>This motor is equipped with vanes for continuous lubrication-free operation. (To obtain the longest possible service life, we recommend no oil in the air.)</p>	<p>All vanes are spring loaded to ensure that they remain pressed against the cylinder when the motor stops. The spring loaded vane option also prevents the vanes from sliding down in their track if vibration is introduced. The spring loaded vanes therefore provide a higher starting torque, improved starting and low speed characteristics, because the leakage over the vanes is reduced to a minimum.</p>	<p>Multi (combination of Z + C) see previous columns</p>

NOTE! All technical data are based on a working pressure of 6 bar and with oil. For oil-free performances are -10 to 15% lower. Data tolerance accuracy +-10%

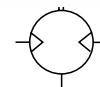

Data for reversible air motor with flattened shaft, P1V-S002A series

Max power	Free speed*	Nominal speed	Nominal torque	Min start torque	Air consumption at max power	Conn.	Min pipe ID	Weight	Order code
kW	rpm	rpm	Nm	Nm	l/s		mm	Kg	
0,02	1300	650	0,29	0,44	1,7	M5	3	0,16	P1V-S002A0130
0,02	950	475	0,40	0,60	1,7	M5	3	0,16	P1V-S002A0095

NOTE! Not available with vane options C, Z or M.
 The P1V-S002A requires oil mist for lubricating the gearbox.
 * maximum admissible speed (idling)

P1V-S002A0130

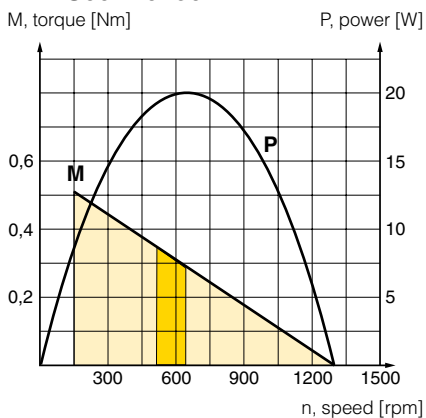

P1V-S002A0095

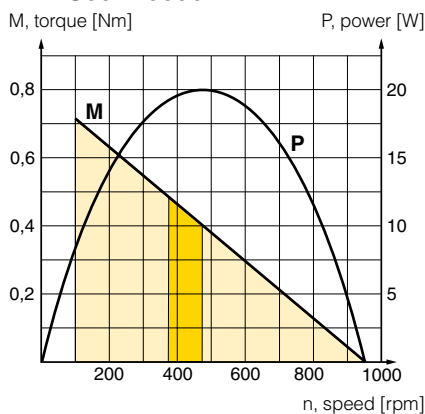

Possible working range of motor.

Optimum working range of motor.
 Higher speeds = more vane wear
 Lower speeds with high torque = more gearbox wear

Dimensions (mm)

Motor P1V-S002

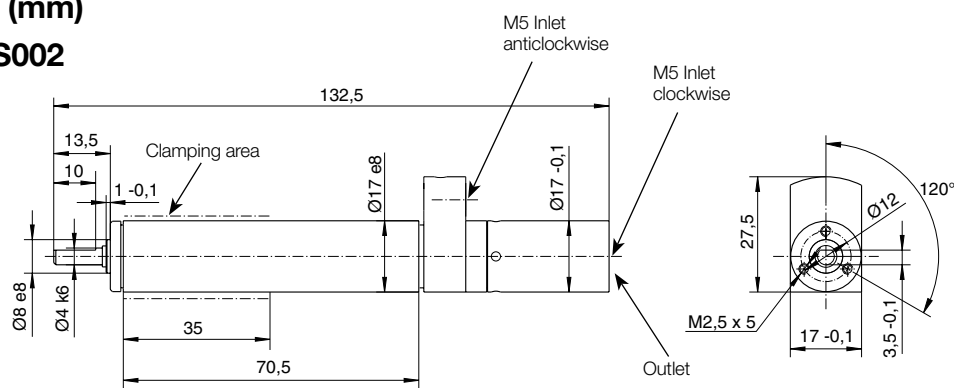

Flange for P1V-S002

P1V-S4002B

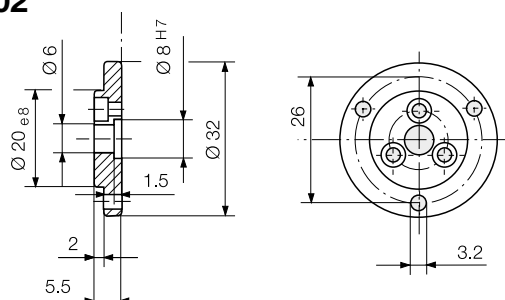

NOTE! All technical data are based on a working pressure of 6 bar and with oil. For oil-free performances are -10 to 15% lower. Data tolerance accuracy +-10%

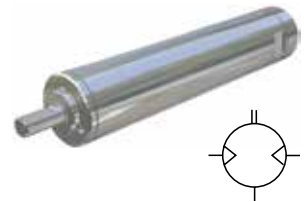

Data for right rotation air motor with flattened shaft, P1V-S003A series

Max power	Free speed*	Nominal speed	Nominal torque	Min start torque	Air consumption at max power	Conn.	Min pipe ID	Weight	Order code
kW	rpm	rpm	Nm	Nm	l/s		mm	Kg	
0,03	1000	500	0,57	0,85	1,7	M8x0,75	3	0,13	P1V-S003B0100

NOTE! Not available with vane options C, Z or M.
 The P1V-S003A requires oil mist for lubricating the gearbox.
 * maximum admissible speed (idling)

P1V-S003B0100

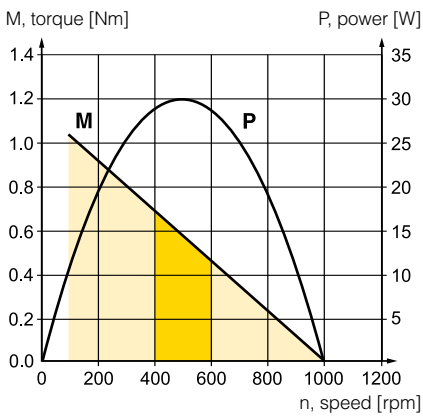

Possible working range of motor.
Optimum working range of motor.
 Higher speeds = more vane wear
 Lower speeds with high torque = more gearbox wear

Motor P1V-S003

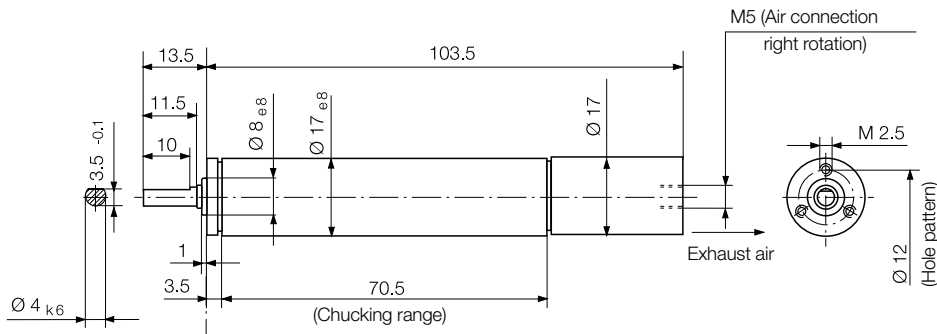

Flange for P1V-S003

P1V-S4002B

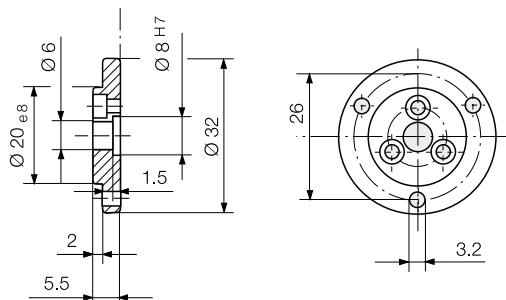

NOTE! All technical data are based on a working pressure of 6 bar and with oil. For oil-free performances are -10 to 15% lower. Data tolerance accuracy +-10%



Data for reversible air motor with flattened shaft, P1V-S008A series

Max power	Free speed*	Nominal speed	Nominal torque	Min start torque	Air consumption at max power	Conn.	Min pipe ID	Weight	Order code
kW	rpm	rpm	Nm	Nm	l/s		mm	Kg	
0,08	22000	11000	0,06	0,09	3,8	M8x0,75**	4	0,20	P1V-S008A0Q00
0,08	7000	3500	0,22	0,33	3,8	M8x0,75**	4	0,20	P1V-S008A0700
0,08	1900	950	0,80	1,20	3,8	M8x0,75**	4	0,22	P1V-S008A0190
0,08	1300	650	1,20	1,80	3,8	M8x0,75**	4	0,22	P1V-S008A0130

** 3 push in nipples for plastic pipe Ø6/4 supplied
 NOTE! Not available with vane options C, Z or M.
 The P1V-S008A requires oil mist for lubricating the gearbox.
 * maximum admissible speed (idling)

P1V-S008A0Q00

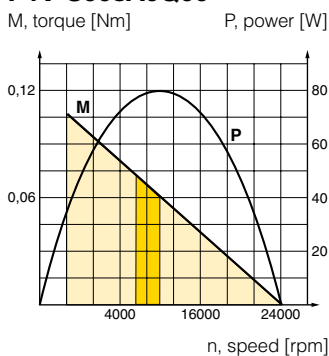

P1V-S008A0700

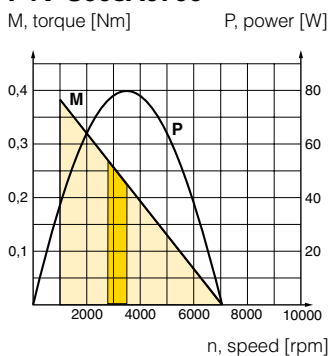

P1V-S008A0190

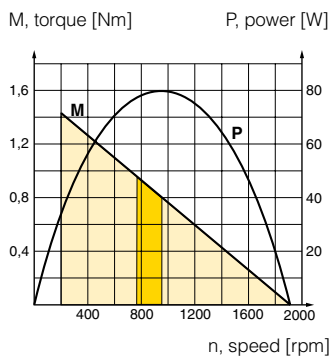

P1V-S008A0130

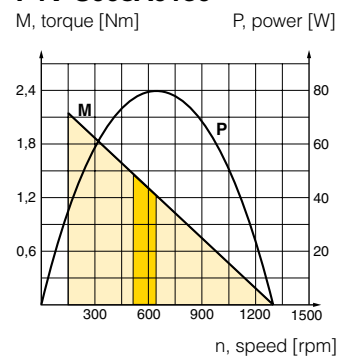

Possible working range of motor.

Optimum working range of motor.
 Higher speeds = more vane wear
 Lower speeds with high torque = more gearbox wear

Dimensions (mm)

Motor P1V-S008

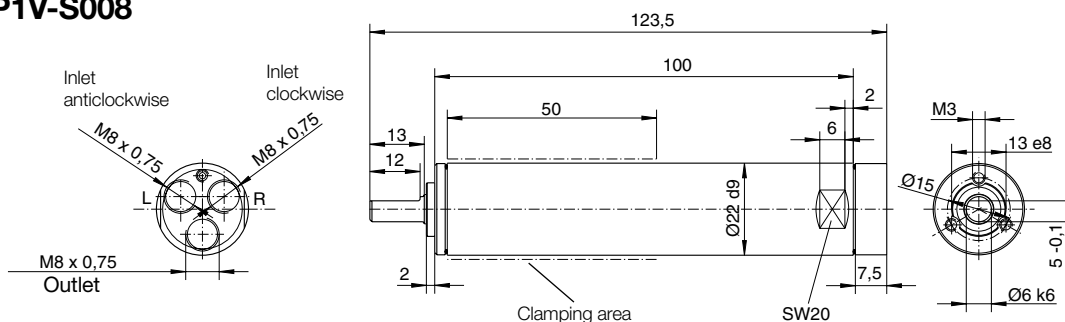

Flange

P1V-S4008B

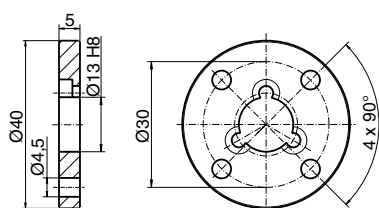

Foot bracket

P1V-S4008F

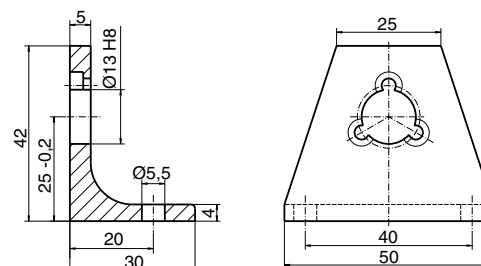

NOTE! All technical data are based on a working pressure of 6 bar and with oil. For oil-free performances are -10 to 15% lower. Data tolerance accuracy +-10%

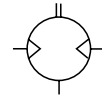

CE Ex II2 GD c IIC T6 (80 °C) X

Data for reversible air motor, P1V-S012A series

Max power	Free speed*	Nominal speed	Nominal torque	Min start torque	Air consumption at max power	Conn.	Min pipe ID	Weight	Order code
kW	rpm	rpm	Nm	Nm	l/s		mm	Kg	
0,120	22000	11000	0,10	0,15	5,0	G1/8	6	0,350	P1V-S012•0N00
0,120	5500	2750	0,40	0,60	5,0	G1/8	6	0,350	P1V-S012•0550
0,120	3600	1800	0,60	0,90	5,0	G1/8	6	0,350	P1V-S012•0360
0,120	1400	700	1,60	2,40	5,0	G1/8	6	0,400	P1V-S012•0140
0,120	900	450	2,50	3,80	5,0	G1/8	6	0,400	P1V-S012•0090
0,120	600	300	3,80	5,00**	5,0	G1/8	6	0,400	P1V-S012•0060
0,090	100	50	5,00**	5,00**	5,0	G1/8	6	0,450	P1V-S012•0010

** Max permitted torque for the gearbox

* maximum admissible speed (idling)
The P1V-S012D with threaded shaft may be reversed, but when operated anticlockwise, there is a risk that the driven unit may disconnect if it is not locked properly.

• A letter for keyed shaft, D for threaded end shaft

P1V-S012•0N00

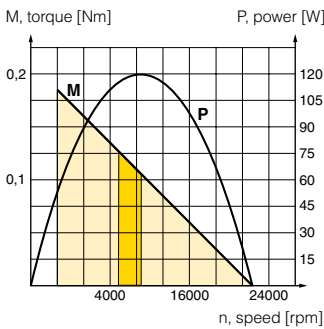

P1V-S012•0550

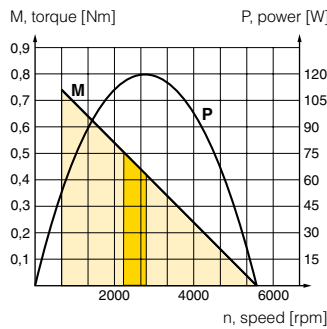

P1V-S012•0360

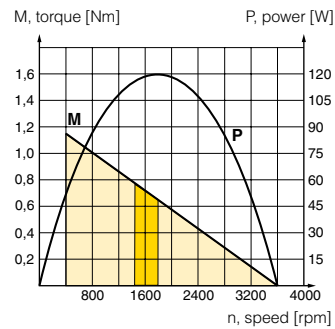

P1V-S012•0140

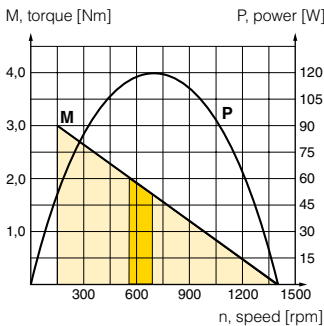

P1V-S012•0090

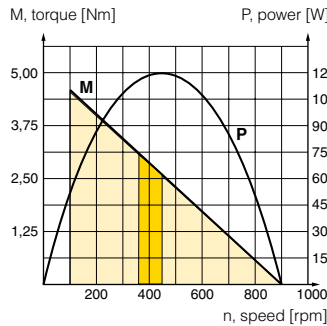

P1V-S012•0060

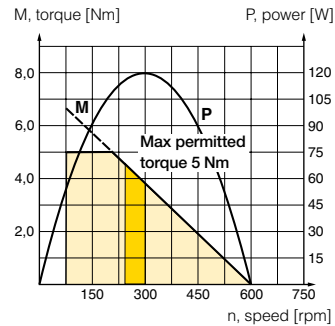

P1V-S012•0010

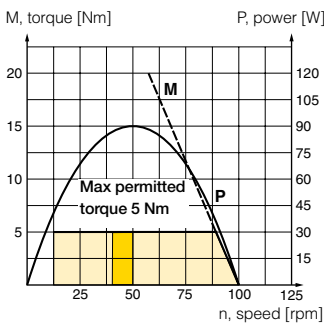

Possible working range of motor.
 Optimum working range of motor.
Higher speeds = more vane wear
Lower speeds with high torque = more gearbox wear

Dimensions (mm)

Motor P1V-S012

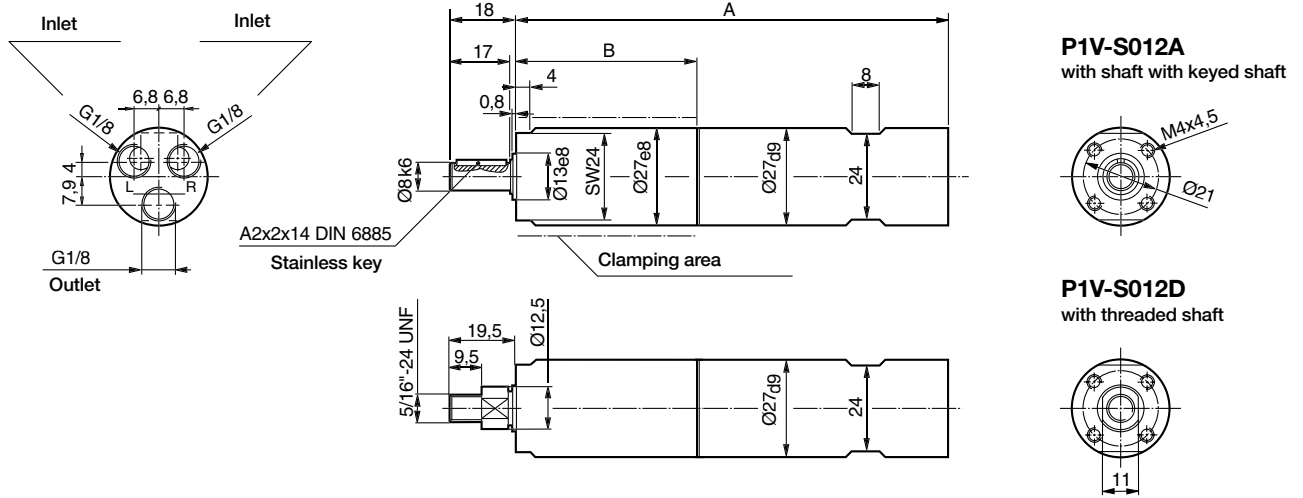

	A	B
P1V-S012A0N00, P1V-S012D0N00	117,0	46,5
P1V-S012A0550, P1V-S012D0550	117,0	46,5
P1V-S012A0360, P1V-S012D0360	117,0	46,5
P1V-S012A0140, P1V-S012D0140	129,5	59,0
P1V-S012A0090, P1V-S012D0090	129,5	59,0
P1V-S012A0060, P1V-S012D0060	129,5	59,0
P1V-S012A0010, P1V-S012D0010	142,0	71,5

Flange

P1V-S4012B

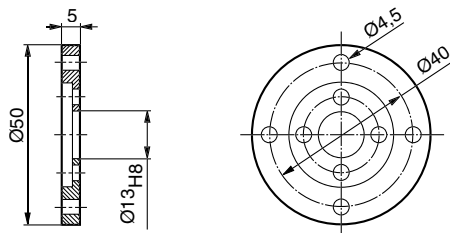

Foot bracket

P1V-S4012F

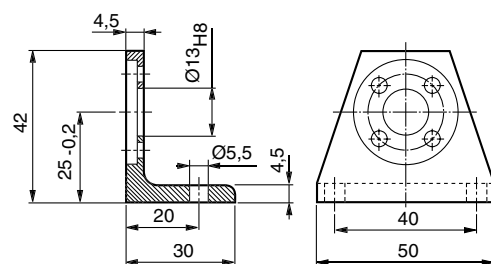

NOTE! All technical data are based on a working pressure of 6 bar and with oil. For oil-free performances are -10 to 15% lower. Data tolerance accuracy +-10%



Data for reversible air motor with keyed shaft, P1V-S020A series

Max power	Free speed*	Nominal speed	Nominal torque	Min start torque	Air consumption at max power	Conn.	Min pipe ID	Weight	Order code
kW	rpm	rpm	Nm	Nm	l/s		mm	Kg	
0,200	14500	7250	0,26	0,40	6,2	G1/8	10	0,700	P1V-S020•0E50
0,200	4600	2300	0,80	1,20	6,2	G1/8	10	0,750	P1V-S020•0460
0,200	2400	1200	1,60	2,40	6,2	G1/8	10	0,750	P1V-S020•0240
0,200	1400	700	2,70	4,10	6,2	G1/8	10	0,850	P1V-S020•0140
0,200	700	350	5,40	8,20	6,2	G1/8	10	0,850	P1V-S020•0070
0,200	320	160	12,00	18,00	6,2	G1/8	10	0,850	P1V-S020•0032
0,100	180	90	10,50	15,00	4,5	G1/8	10	0,850	P1V-S020•0018
0,180	50	25	20**	20**	6,2	G1/8	10	0,950	P1V-S020•0005
0,180	20	-	20**	20**	6,2	G1/8	10	0,950	P1V-S020A0002
0,180	10	-	20**	20**	6,2	G1/8	10	1,050	P1V-S020A0001
0,180	5	-	20**	20**	6,2	G1/8	10	1,050	P1V-S020A00005

** Max permitted torque to not damage the gearbox.

* maximum admissible speed (idling)

The P1V-S020D with threaded shaft may be reversed, but when operated anticlockwise, there is a risk that the driven unit may disconnect if it is not locked properly.



Possible working range of motor.



Optimum working range of motor.

Higher speeds = more vane wear
Lower speeds with high torque = more gearbox wear

- A letter for keyed shaft,
- D for threaded end shaft

P1V-S020•0E50

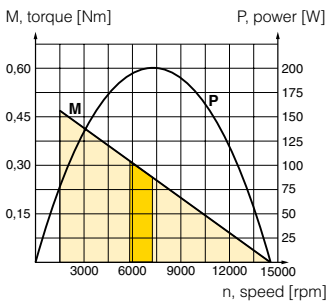

P1V-S020•0460

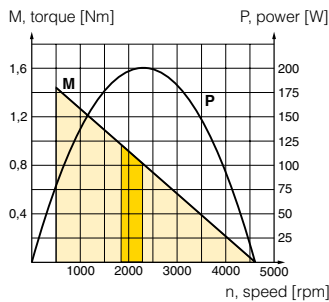

P1V-S020•0240

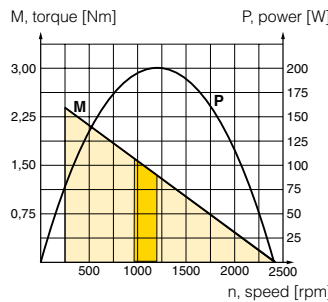

P1V-S020•0140

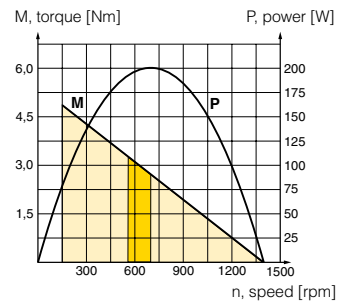

P1V-S020•0070

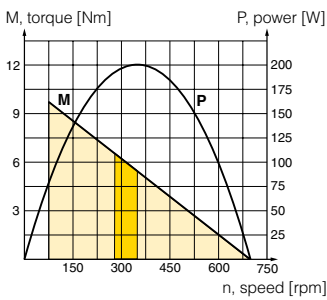

P1V-S020•0032

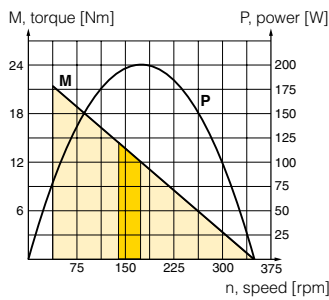

P1V-S020•0018

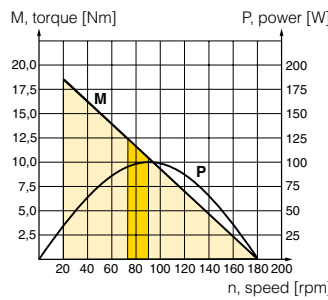

P1V-S020•0005

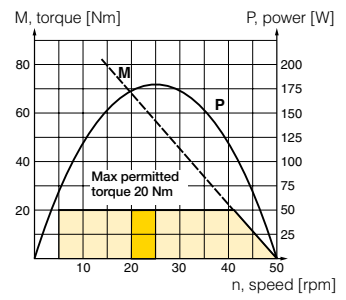

P1V-S020A0002

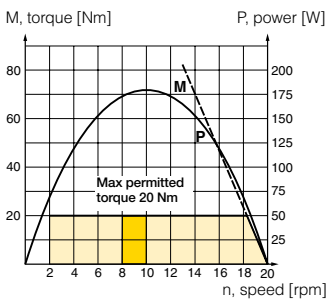

P1V-S020A0001 & P1V-S020A00005

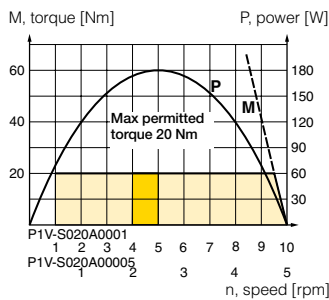

Dimensions (mm)
Motor P1V-S020

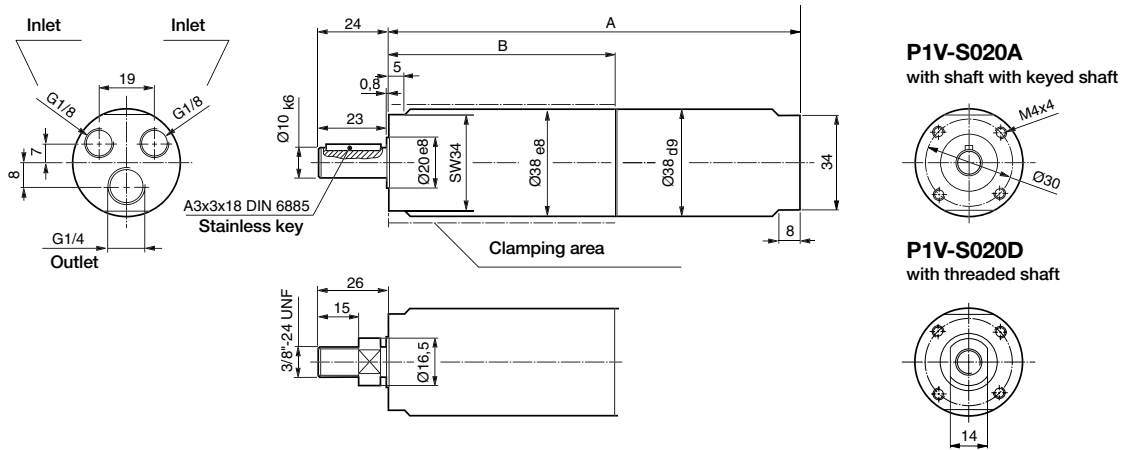

	A	B
P1V-S020A0E50, P1V-S020D0E50	127	63,5
P1V-S020A0460, P1V-S020D0460	127	63,5
P1V-S020A0240, P1V-S020D0240	127	63,5
P1V-S020A0140, P1V-S020D0140	143	79,5
P1V-S020A0001, P1V-S020D0001	143	79,5
P1V-S020A0035, P1V-S020D0035	143	79,5
P1V-S020A0018, P1V-S020D0018	143	79,5
P1V-S020A0005, P1V-S020D0005	159	95,5
P1V-S020A0002	159	95,5
P1V-S020A0001	175	111,5
P1V-S020A00005	175	111,5

Flange

P1V-S4020B

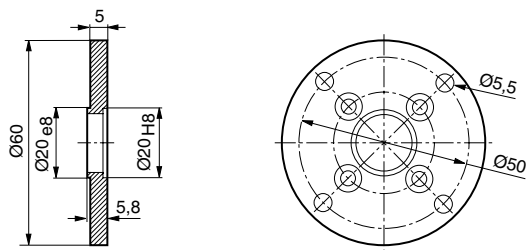

Foot bracket

P1V-S4020F

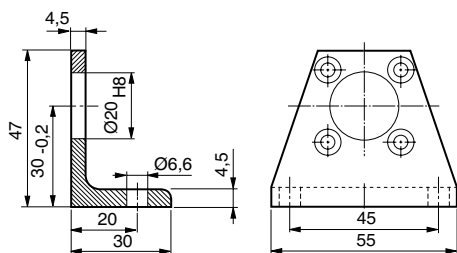

NOTE! All technical data are based on a working pressure of 6 bar and with oil. For oil-free performances are -10 to 15% lower. Data tolerance accuracy +-10%



CE **Ex** II2 GD c IIC T6 (80 °C) X

Data for reversible air motor with keyed shaft, P1V-S030A series

Max power	Free speed*	Nominal speed	Nominal torque	Min start torque	Air consumption at max power	Conn.	Min pipe ID	Weight	Order code
kW	rpm	rpm	Nm	Nm	l/s		mm	Kg	
0,300	14500	7250	0,40	0,60	7,8	G1/4	10	1,000	P1V-S030•0E50
0,300	4600	2300	1,20	1,90	7,8	G1/4	10	1,050	P1V-S030•0460
0,300	2400	1200	2,40	3,60	7,8	G1/4	10	1,050	P1V-S030•0240
0,300	1400	700	4,10	6,10	7,8	G1/4	10	1,100	P1V-S030•0140
0,300	600	300	9,60	14,30	7,8	G1/4	10	1,150	P1V-S030•0060
0,300	340	170	16,90	25,30	7,8	G1/4	10	1,150	P1V-S030•0034
0,300	230	115	24,00	36,00	7,8	G1/4	10	3,300	P1V-S030A0023
0,130	180	90	13,80	21,00	4,7	G1/4	10	1,150	P1V-S030•0018
0,300	100	50	57,00	85,50	7,8	G1/4	10	3,300	P1V-S030A0010
0,280	50	25	36**	36**	7,8	G1/4	10	1,250	P1V-S030•0005

** Max permitted torque to not damage the gearbox.

* maximum admissible speed (idling)
The P1V-S030D with threaded shaft may be reversed, but when operated anticlockwise, there is a risk that the driven unit may disconnect if it is not locked properly.

• A letter for keyed shaft, D for threaded end shaft

P1V-S030•0E50

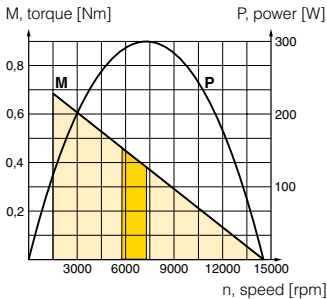

P1V-S030•0460

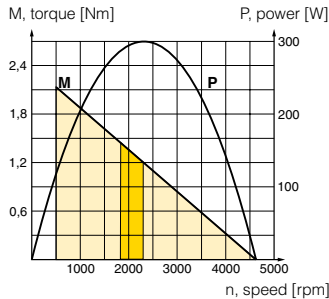

P1V-S030•0240

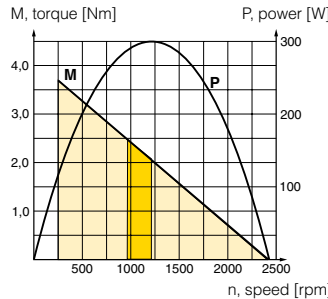

P1V-S030•0140

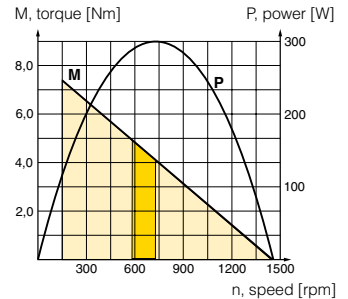

P1V-S030•0060

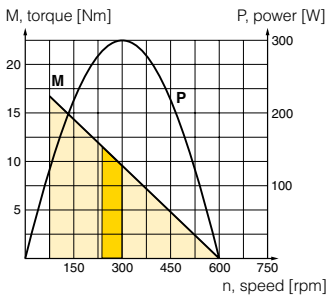

P1V-S030•0034

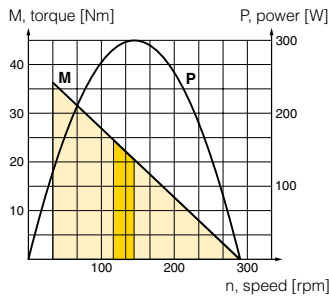

P1V-S030A0023

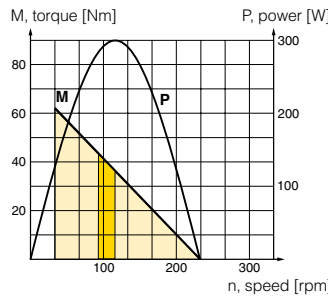

P1V-S030•0018

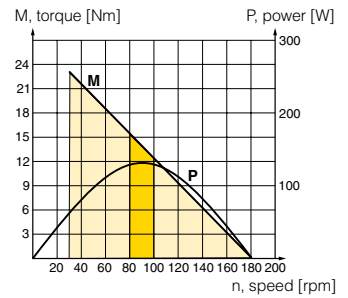

P1V-S030A0010

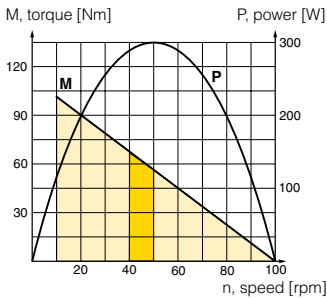

P1V-S030•0005

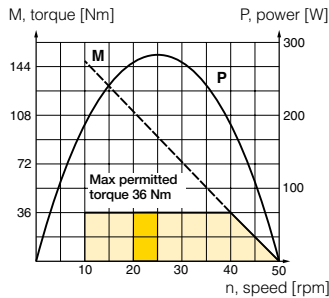

Possible working range of motor.
 Optimum working range of motor.
 Higher speeds = more vane wear
 Lower speeds with high torque = more gearbox wear

Dimensions (mm)

Motor P1V-S030

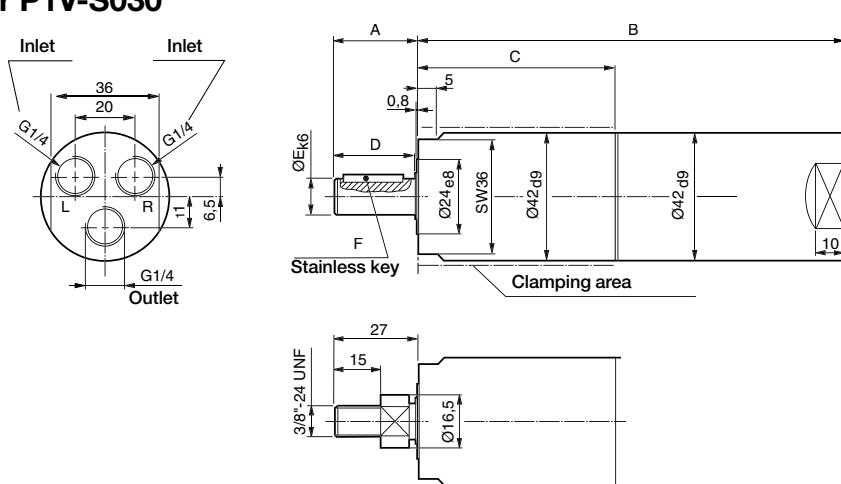

P1V-S030A
with shaft with keyed shaft

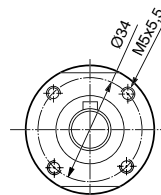

P1V-S030D
with threaded shaft

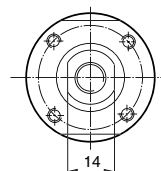

	A	B	C	D	E	F
P1V-S030A0E50, P1V-S030D0E50	28,5	143	66	27	12	A4x4x20 DIN 6885
P1V-S030A0460, P1V-S030D0460	28,5	143	66	27	12	A4x4x20 DIN 6885
P1V-S030A0240, P1V-S030D0240	28,5	143	66	27	12	A4x4x20 DIN 6885
P1V-S030A0140, P1V-S030D0140	28,5	159	82	27	12	A4x4x20 DIN 6885
P1V-S030A0060, P1V-S030D0060	32,0	159	82	30	14	A5x5x20 DIN 6885
P1V-S030A0034, P1V-S030D0034	32,0	159	82	30	14	A5x5x20 DIN 6885
P1V-S030A0018, P1V-S030D0018	32,0	159	82	30	14	A5x5x20 DIN 6885
P1V-S030A0005, P1V-S030D0005	32,0	164	82	30	14	A5x5x20 DIN 6885

Flange

P1V-S4030B

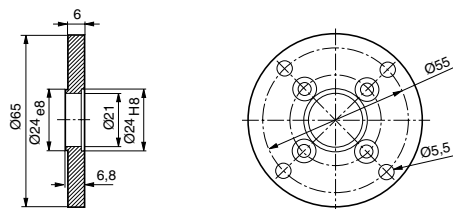

Foot bracket

P1V-S4030F

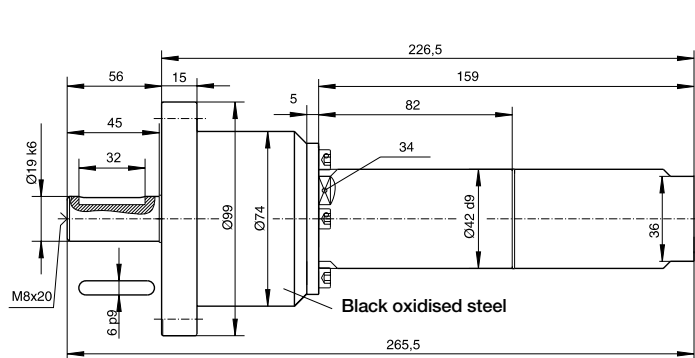
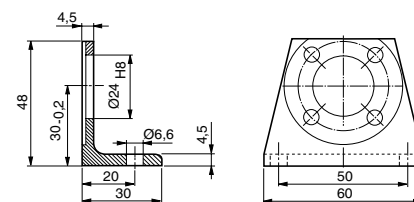

P1V-S030A0023
P1V-S030A0010

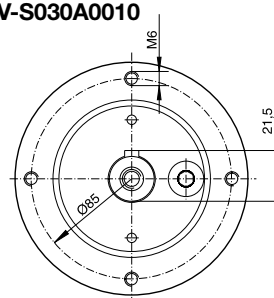

Foot bracket for motors

P1V-S030A0023 and P1V-S030A0010

P1V-S4020C

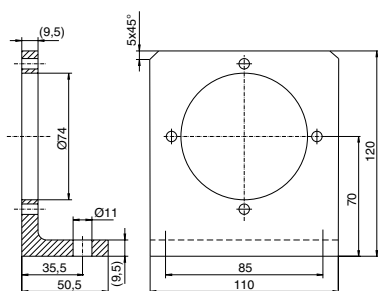

NOTE! All technical data are based on a working pressure of 6 bar and with oil. For oil-free performances are -10 to 15% lower. Data tolerance accuracy +-10%



CE II2 GD c IIC T6 (80 °C) X

Data for reversible air motor with keyed shaft, P1V-S060A series

Max power	Free speed*	Nominal speed	Nominal torque	Min start torque	Air consumption at max power	Conn.	Min pipe ID	Weight	Order code
kW	rpm	rpm	Nm	Nm	l/s		mm	Kg	
0,600	14000	7000	0,82	1,23	14,2	G3/8	12	2,200	P1V-S060A0E00
0,600	3500	1750	3,20	4,80	14,2	G3/8	12	2,300	P1V-S060A0350
0,600	2700	1350	4,20	6,40	14,2	G3/8	12	2,300	P1V-S060A0270
0,600	1700	850	6,70	10,10	14,2	G3/8	12	2,300	P1V-S060A0170
0,600	630	315	18,00	27,00	14,2	G3/8	12	2,600	P1V-S060A0063
0,600	480	240	24,00	36,00	14,2	G3/8	12	2,700	P1V-S060A0048
0,600	300	150	38,00	57,00	14,2	G3/8	12	2,700	P1V-S060A0030
0,300	150	75	38,00	57,00	14,2	G3/8	12	2,700	P1V-S060A0015

* maximum admissible speed (idling)

P1V-S060A0E00

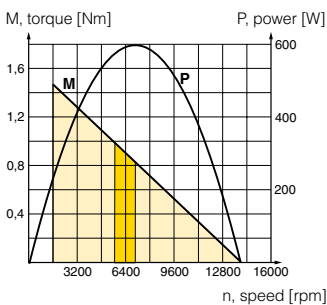

P1V-S060A0350

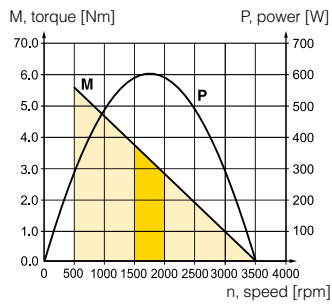

P1V-S060A0270

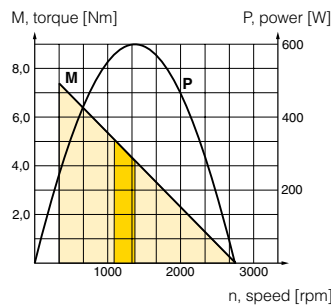

P1V-S060A0170

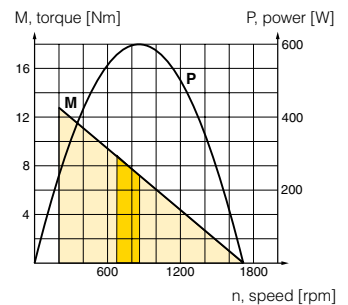

P1V-S060A0063

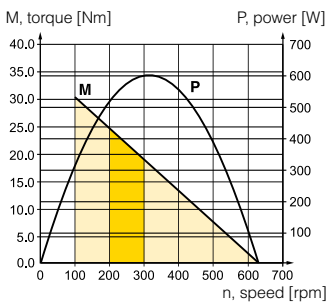

P1V-S060A0048

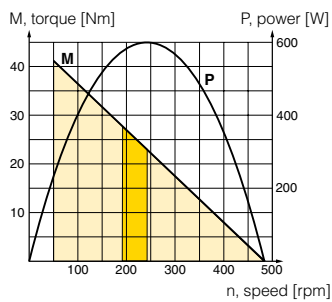

P1V-S060A0030

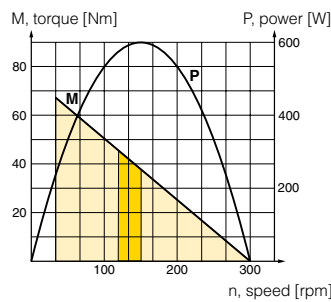

P1V-S060A0015

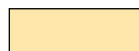
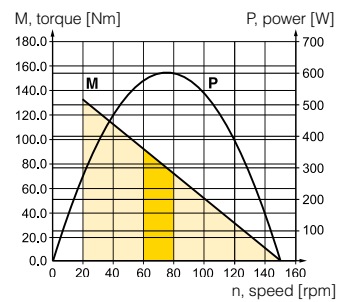

Possible working range of motor.



Optimum working range of motor.

Higher speeds = more vane wear
Lower speeds with high torque = more gearbox wear

Dimensions (mm)

Motor P1V-S060

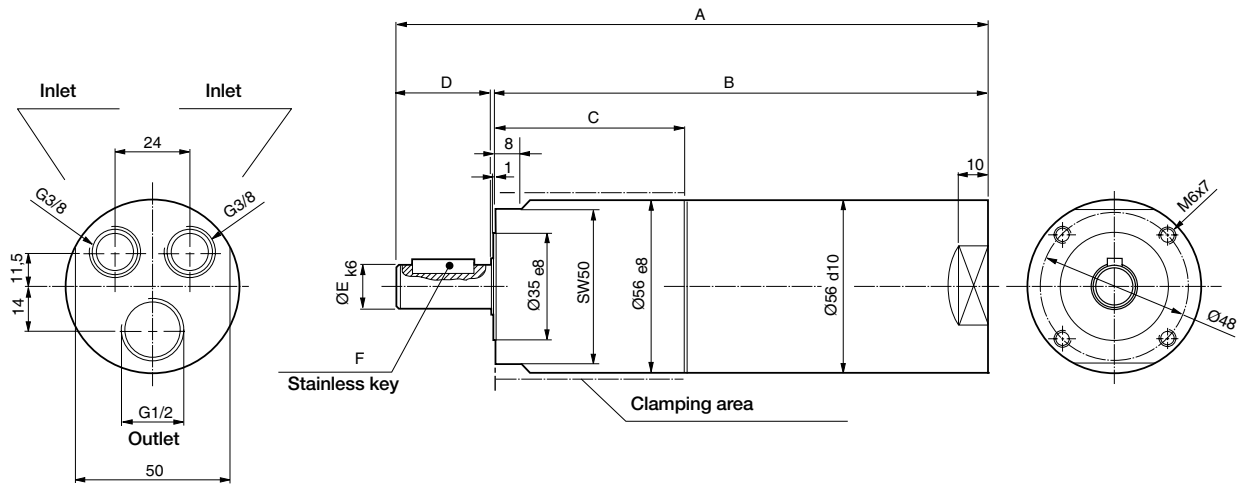

	A	B	C	D	E	F
P1V-S060A0E00	197	165,5	66	30	14	A5x5x20 DIN 6885
P1V-S060A0350	197	165,5	66	30,5	14	A5x5x20 DIN 6885
P1V-S060A0270	197	165,5	66	30,5	14	A5x5x20 DIN 6885
P1V-S060A0170	197	165,5	66	30,5	14	A5x5x20 DIN 6885
P1V-S060A0063	215	183,5	84	30,5	14	A5x5x20 DIN 6885
P1V-S060A0048	217	180,0	80,5	36	19	A6x6x22 DIN 6885
P1V-S060A0030	217	180,0	80,5	36	19	A6x6x22 DIN 6885
P1V-S060A0015	217	180,0	80	35	19	A6x6x22 DIN 6885

Flange

P1V-S4060B

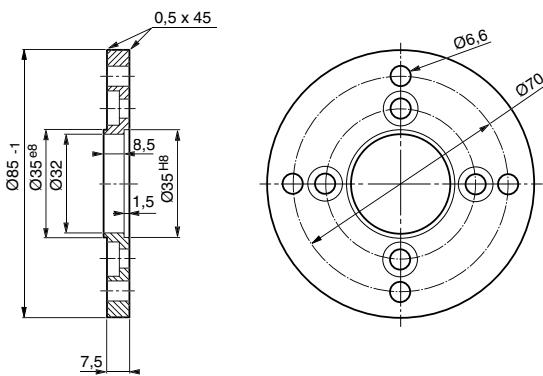

Foot bracket

P1V-S4060F

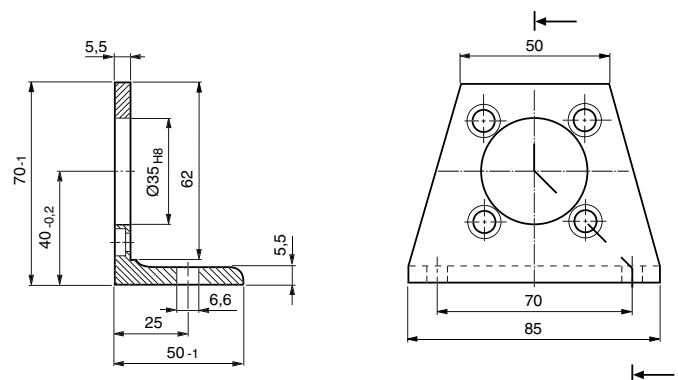

NOTE! All technical data are based on a working pressure of 6 bar and with oil. For oil-free performances are -10 to 15% lower. Data tolerance accuracy +-10%



CE II2 GD c IIC T6 (80 °C) X

Data for reversible air motor with keyed shaft, P1V-S090A series

Max power	Free speed*	Nominal speed	Nominal torque	Min start torque	Air consumption at max power	Conn.	Min pipe ID	Weight	Order code
kW	rpm	rpm	Nm	Nm	l/s		mm	Kg	
0,900	12000	6000	1,40	2,10	23,3	G1/2	12	2,500	P1V-S090A0C00
0,900	3500	1750	4,90	7,30	23,3	G1/2	12	2,600	P1V-S090A0350
0,900	2700	1350	6,30	9,50	23,3	G1/2	12	2,600	P1V-S090A0270
0,900	1700	850	10,10	15,20	23,3	G1/2	12	2,600	P1V-S090A0170
0,900	630	315	27,00	40,00	23,3	G1/2	12	2,900	P1V-S090A0063
0,900	480	240	35,00	53,00	23,3	G1/2	12	3,000	P1V-S090A0048
0,900	300	150	57,00	85,00	23,3	G1/2	12	3,000	P1V-S090A0030

** Max permitted torque to not damage the gearbox.
 * Maximum admissible speed (idling)

P1V-S090A0C00

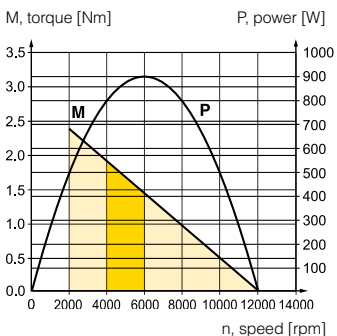

P1V-S090A0350

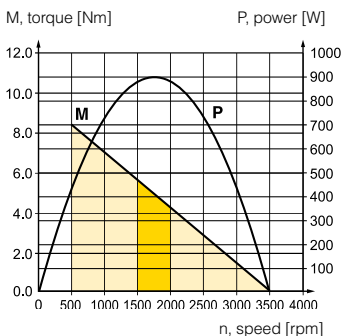

P1V-S090A0270

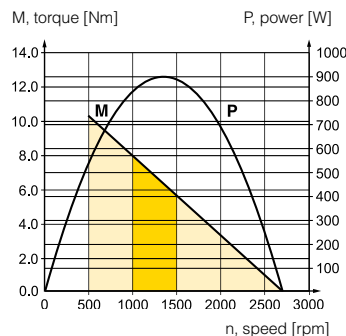

P1V-S090A0170

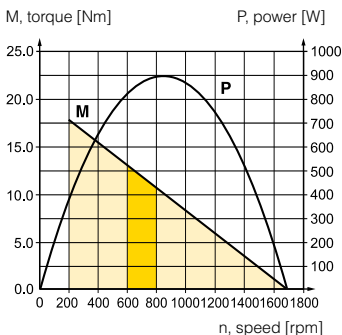

P1V-S090A0063

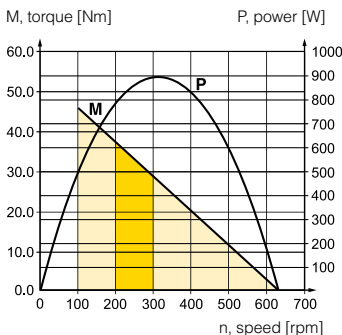

P1V-S090A0048

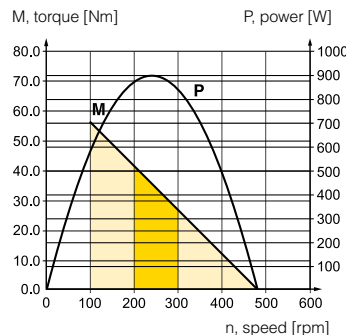

P1V-S090A0030

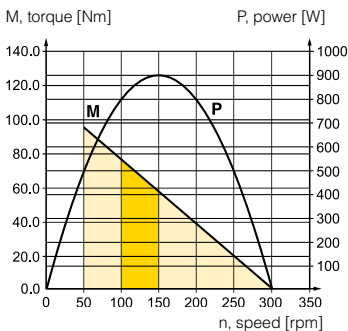

Possible working range of motor.
 Optimum working range of motor.
 Higher speeds = more vane wear
 Lower speeds with high torque = more gearbox wear

Dimensions (mm)

Motor P1V-S090

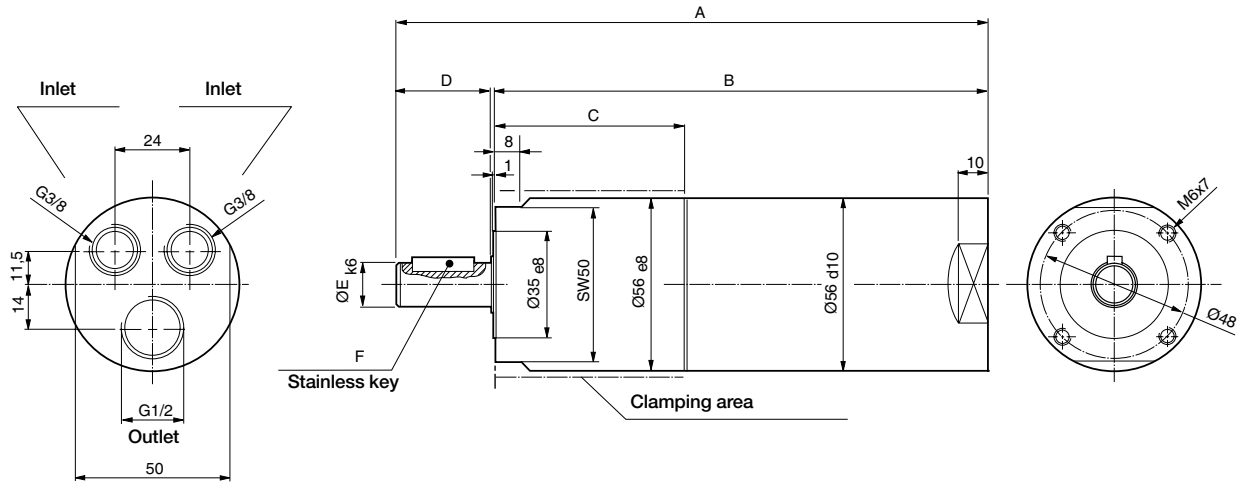

	A	B	C	D	E	F
P1V-S090A0C00	217	185,5	67	30,5	14	A5x5x20 DIN 6885
P1V-S090A0350	217	185,5	67	30,5	14	A5x5x20 DIN 6885
P1V-S090A0270	217	185,5	67	30,5	14	A5x5x20 DIN 6885
P1V-S090A0170	217	185,5	67	30,5	14	A5x5x20 DIN 6885
P1V-S090A0063	235	203,5	85	30,5	14	A5x5x20 DIN 6885
P1V-S090A0048	237	200,0	81	36	19	A6x6x22 DIN 6885
P1V-S090A0030	237	200,0	81	36	19	A6x6x22 DIN 6885

Flange

P1V-S4060B

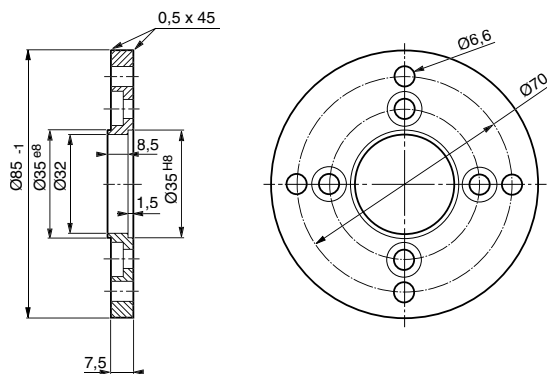

Foot bracket

P1V-S4060F

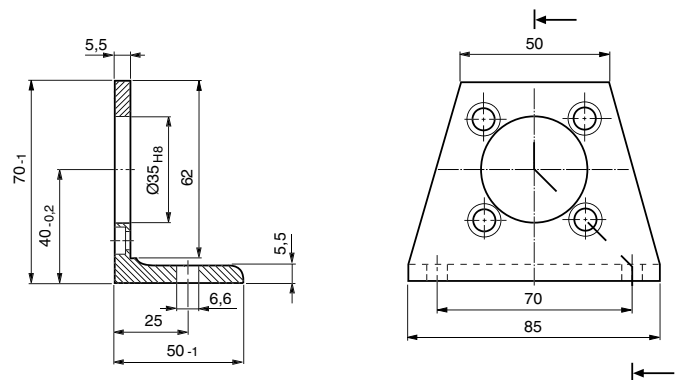

NOTE! All technical data are based on a working pressure of 6 bar and with oil. For oil-free performances are -10 to 15% lower. Data tolerance accuracy +-10%



CE II2 GD c IIC T5 (95 °C) X

Data for reversible air motor with keyed shaft, P1V-S120A series

Max power	Free speed*	Nominal speed	Nominal torque	Min start torque	Air consumption at max power	Conn.	Min pipe ID	Weight	Order code
kW	rpm	rpm	Nm	Nm	l/s		mm	Kg	
1,200	9000	4500	2,50	3,80	26,7	G3/4	19	5,5	P1V-S120A0900
1,200	2500	1250	9,20	13,70	26,7	G3/4	19	5,5	P1V-S120A0250
1,200	1100	550	21,00	31,00	26,7	G3/4	19	6,1	P1V-S120A0110
1,200	700	350	33,00	49,00	26,7	G3/4	19	5,6	P1V-S120A0070
1,200	320	160	71,00	107,00	26,7	G3/4	19	6,7	P1V-S120A0032
0,700	200	100	66,90	100,00	19	G3/4	19	6,7	P1V-S120A0020

* Maximum admissible speed (idling)

P1V-S120A0900

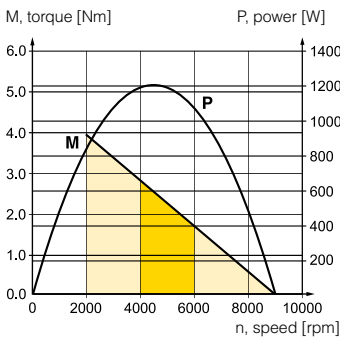

P1V-S120A0250

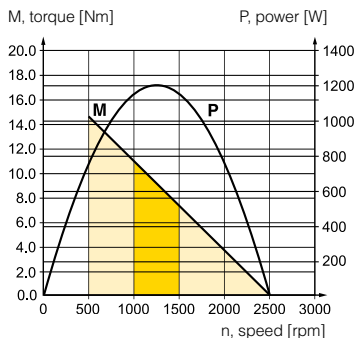

P1V-S120A0110

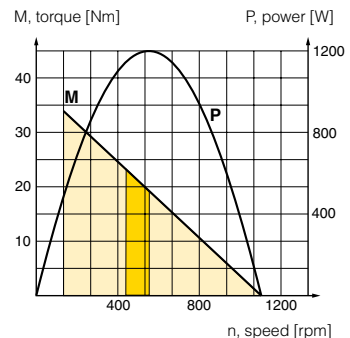

P1V-S120A0070

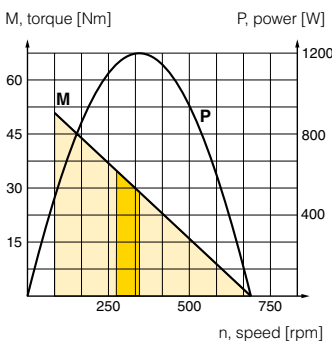

P1V-S120A0032

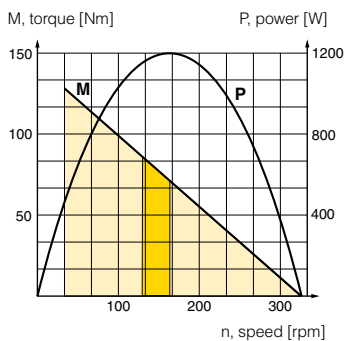

P1V-S120A0020

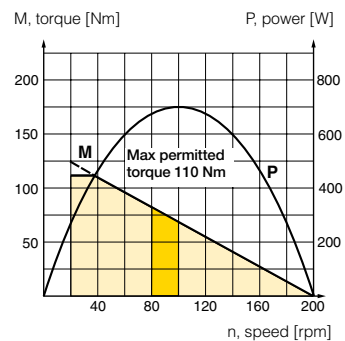

Possible working range of motor.

Optimum working range of motor.

Higher speeds = more vane wear
Lower speeds with high torque = more gearbox wear

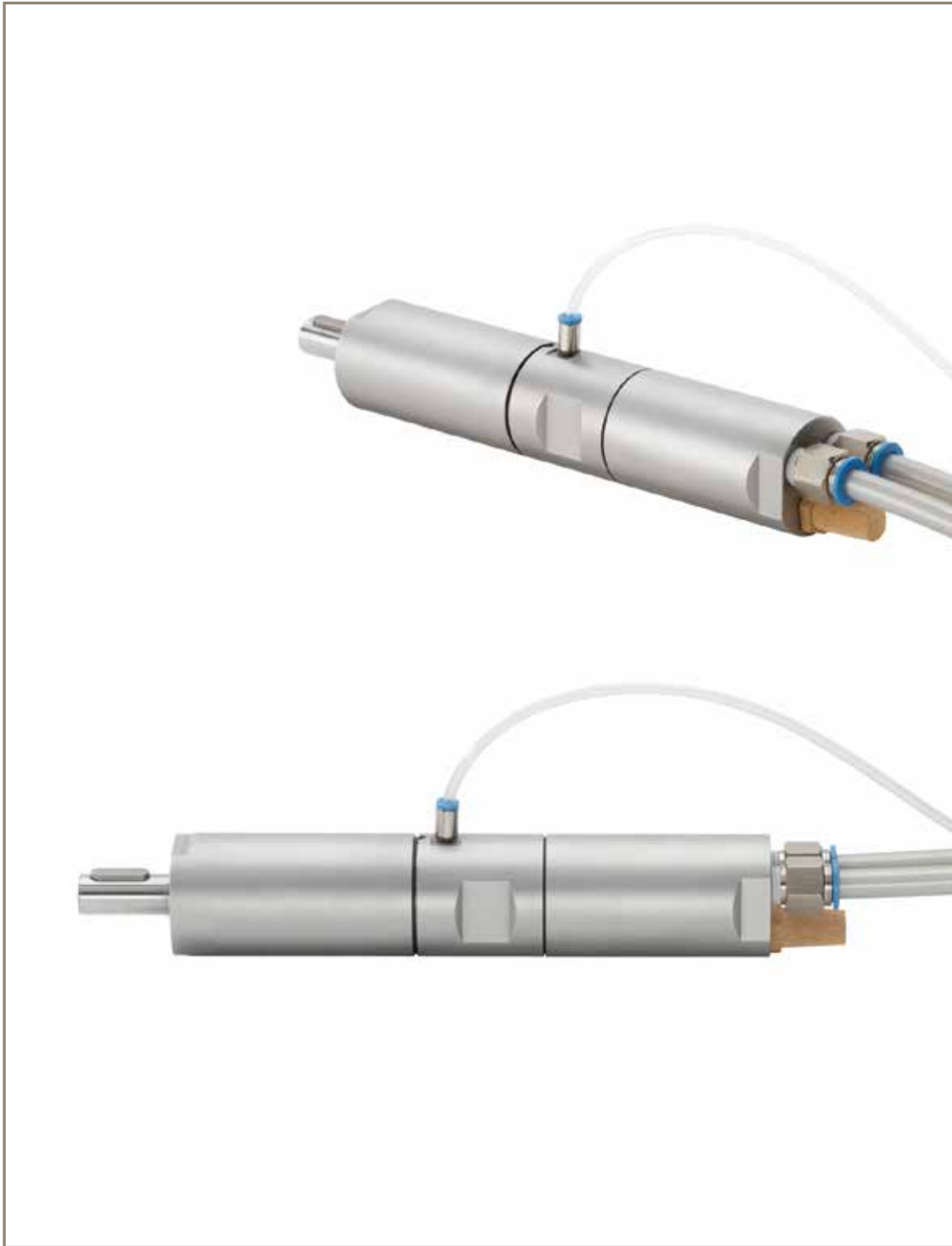

Air Motors

P1V-S Stainless Steel with Brake Type
200, 300 & 1200 Watts

Contents	Page
Introduction	38
Technical data	39
Material specification	39
Stainless Steel Air Motors with Brakes 200 watts	40
Dimensions	41
Stainless Steel Air Motors with Brakes 300 watts	42
Dimensions	43
Stainless Steel Air Motors with Brakes 1200 watts	44
Dimensions	45
Mountings	56
Lubrication and service life	57
Service kits	58 - 59

Introduction

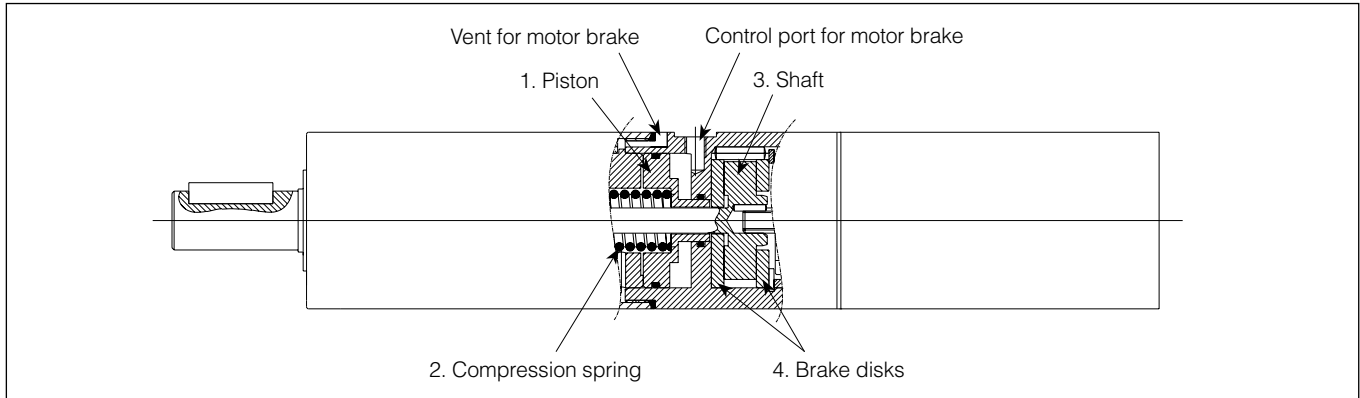

Applications

The integrated brake is a spring-loaded disk brake, which is released at a minimum air pressure of 5 bar. The brake is applied in the absence of pressure. As soon as the control port for the brake is placed under pressure, the piston (1) is pressurised and the spring (2) is compressed. The motor can now start and the torque is passed to the shaft (3). The ventilation air from the brake is connected with the atmosphere. In order to brake the motor, the control air to the brake is simply vented. The piston (1) is pushed to the right by the spring (2), and the axle (3) is jammed between the two brake disks (4).

The technology and the size of air motors with stationary brake make them ideal for applications requiring short stops after having cutting air pressure inside the air motors for blocking the rotation. Another typical application for brake motors is when the output shaft needs to be held in one position when the motor stops delivering torque and must stay in position. The brake can handle more than 1500 braking operations per hour at maximum braking torque.

Disassembly and Reassembly

Detach the connections with the motor and gearbox. Pull off the motor and gearbox part. The brake disks can be lifted off after the lock ring has been removed.

Service and Maintenance

After 20 000 braking operations as a stationary brake or 10 000 braking operations as an operating brake, the brake must be disassembled in order to check for wear.

Warning:

If the number of braking operations is exceeded, the degree of wear might be greater than permitted and the braking effect might be lost. If this happens, you simply need to replace the worn brake linings. Tests show that the brake lining needs to be replaced after approx. 90 000 braking cycles.

NOTE!

Brake motors must only ever be supplied with unlubricated air, otherwise there is a risk of oil from the supply air getting into the brake unit, resulting in poor brake performance or no braking effect.

Air motor size & type	200 watts, ●●● = 020		300 watts, ●●● = 030		1200 watts, ●●● = 120	
	Motor Max torque Nm	Theoretical min braking torque Nm	Motor Max torque Nm	Theoretical min braking torque Nm	Motor Max torque Nm	Theoretical min braking torque Nm
P1V-S●●●ADE50	0.52	1	0.8	1	-	-
P1V-S120AD900	-	-	-	-	5	6.2
P1V-S●●●AD460	1.6	3.4	2.4	3.4	-	-
P1V-S120AD250	-	-	-	-	18.4	2.3
P1V-S●●●AD240	3.2	6.7	4.8	6.7	-	-
P1V-S●●●AD140	5.4	11.8	8.2	11.8	-	-
P1V-S120AD110	-	-	-	-	42	52
P1V-S●●●AD070	10.8	20	-	-	66	83
P1V-S●●●AD034	-	-	19.2	36	-	-
P1V-S●●●AD032	24	44.4	-	-	142	177
P1V-S030AD023	-	-	48	70.8	-	-
P1V-S●●●AD018	21	44.4	47.2	123.6	-	-
P1V-S020AD011	66	137.2	-	-	-	-
P1V-S030AD010	-	-	114	123.6	-	-
P1V-S020AD006	144	266.4	-	-	-	-
P1V-S●●●AD005	20*	44.4	36*	40	-	-
P1V-S020AD002	20*	44.4	-	-	-	-
P1V-S020AD001	20*	44.4	-	-	-	-
P1V-S020AD0005	20*	44.4	-	-	-	-

*Warning !: the permitted torque for the specific gearbox must not be exceeded.

Brake release: minimum air pressure of 5 bar

Technical data

Air motor size & type	P1V-S020	P1V-S030	P1V-S120
Nominal power (watts)	200	300	1200
Working pressure (bar)	3 to 7, 6 in explosive atmosphere (with brake not atex certified)		
Working temperature (°C)	-20 to +110		
Ambient temperature (°C)	-20 to +40 in explosive atmosphere (with brake not atex certified)		
Air flow required (l/min)	370	470	1600
Min pipe ID, inlet (mm)	10	10	19
Min pipe ID, outlet (mm)	10	10	19

Choice of treatment unit: recommended min air flow (l/min) at p1 7.5 bar and 0.8 bar pressure drop

	410	510	1800
Medium	40µm filtered, oil mist or dry unlubricated compressed air		
Oil free operation, indoor	ISO8573-1 purity class 3.4.1		
Oil free operation, outdoor	ISO8573-1 purity class 1.2.1		
Oil operation	1-2 drop per cube meter, ISO8573-1 purity class 3.-.5		
Recommended oil	Foodstuffs industry Klüber oil 4 UH1- 32 N		

Choice of valve: recommended min nominal air flow (l/min) at p1 6 bar and 1 bar pressure drop

	450	550	2000
Sound level free outlet (dB(A))	100	103	108
With outlet silencer (dB(A))	82	91	95
Exhaust air removed with pipes to another room	71	70	87

Note: sound levels are measured at free speed with the measuring instrument positioned 1 meter away from the air motor at an height of 1 meter.

Table and diagram data

All technical data are based on a working pressure of 6 bar and with oil. Oil-free performances are -10 to 15% lower. Data tolerance accuracy +-10%

Material specification

Air motor size & type	P1V-S020	P1V-S030	P1V-S120
Planetary gearbox housing	Stainless steel		
Planetary gearbox housing for last planet stage including installation flange	Stainless Steel or Black oxidised steel (not stainless)		Stainless steel
Air motor housing	Stainless steel		
Shaft	Hardened stainless steel		
Key	Hardened stainless steel		
External seal Fluor rubber	Fluor rubber FPM		
Internal steel parts	High grade steel (not stainless)		
Planetary gear grease used in	Grease, Shell Cassida RLS2		
Screws in housing in last planet stage	Surface treated steel (not stainless)		
Accessories	P1V		
Flange bracket	Stainless steel		
Foot bracket	Stainless steel		
Screws for the mountings	Stainless steel DIN A2		

NOTE! All technical data are based on a working pressure of 6 bar and with oil. For oil-free performances are -10 to 15% lower. Data tolerance accuracy +-10%

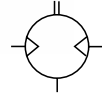

IMPORTANT! Non Atex certified

Data for reversible brake motor with keyed shaft, P1V-S020AD series

Max power	Free speed*	Nominal speed	Nominal torque	Min start torque	Air consumption at max power	Conn.	Min pipe ID	Weight	Order code
kW	rpm	rpm	Nm	Nm	l/s		mm	Kg	
0,200	14500	7250	0,26	0,40	6,2	G1/8	10	1,000	P1V-S020ADE50
0,200	4600	2300	0,80	1,20	6,2	G1/8	10	1,050	P1V-S020AD460
0,200	2400	1200	1,60	2,40	6,2	G1/8	10	1,050	P1V-S020AD240
0,200	1400	700	2,70	4,10	6,2	G1/8	10	1,150	P1V-S020AD140
0,200	700	350	5,40	8,20	6,2	G1/8	10	1,150	P1V-S020AD070
0,200	320	160	12,00	18,00	6,2	G1/8	10	1,150	P1V-S020AD032
0,100	180	90	10,50	15,00	4,5	G1/8	10	1,150	P1V-S020AD018
0,180	50	25	20,00**	20,00**	6,2	G1/8	10	1,250	P1V-S020AD005
0,180	20	-	20,00**	20,00**	6,2	G1/8	10	1,250	P1V-S020AD002
0,180	10	-	20,00**	20,00**	6,2	G1/8	10	1,350	P1V-S020AD001
0,180	5	-	20,00**	20,00**	6,2	G1/8	10	1,350	P1V-S020AD0005

** Max permitted torque to not damage the gearbox.

* maximum admissible speed (idling)

The P1V-S020D with threaded shaft may be reversed, but when operated anticlockwise, there is a risk that the driven unit may disconnect if it is not locked properly.



Possible working range of motor.



Optimum working range of motor.

Higher speeds = more vane wear
Lower speeds with high torque = more gearbox wear

P1V-S020ADE50

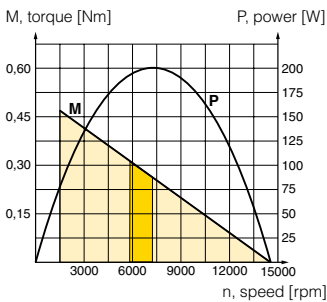

P1V-S020AD460

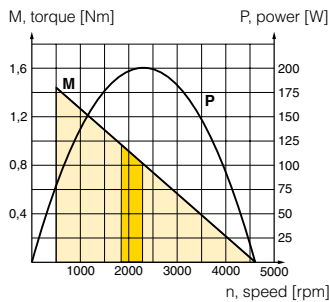

P1V-S020AD240

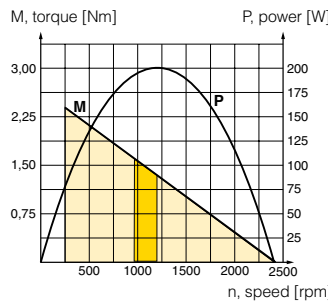

P1V-S020AD140

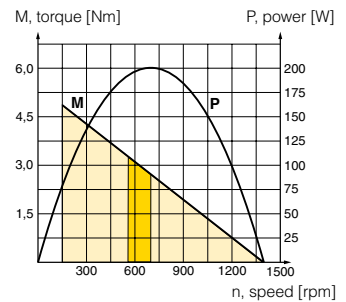

P1V-S020AD070

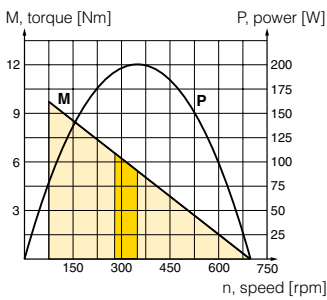

P1V-S020AD032

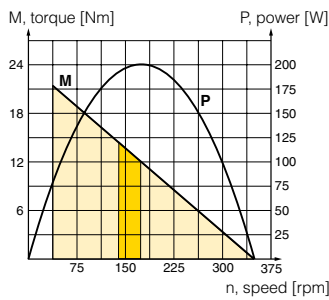

P1V-S020AD018

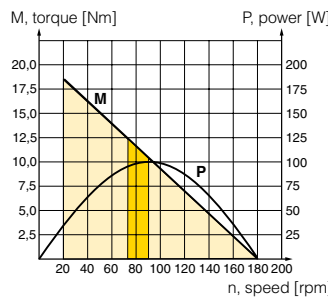

P1V-S020AD005

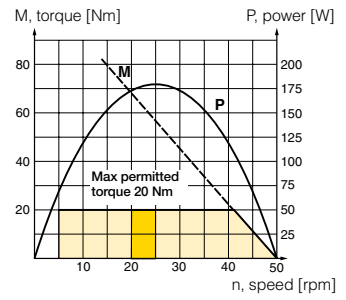

P1V-S020AD002

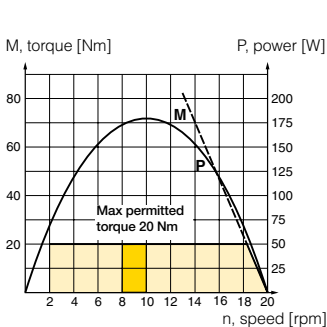

P1V-S020AD001 & P1V-S020AD0005

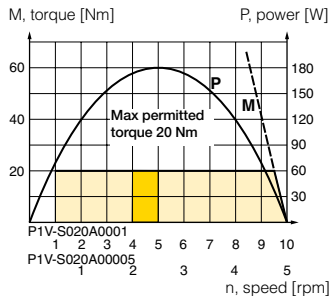

Dimensions (mm)

Brake motor P1V-S020

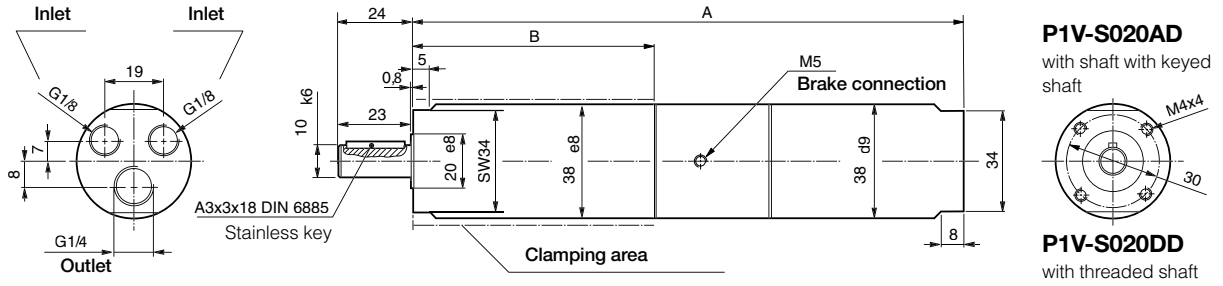

	A	B
P1V-S020ADE50	170	63,5
P1V-S020AD460	170	63,5
P1V-S020AD240	170	63,5
P1V-S020AD140	186	79,5
P1V-S020AD070	186	79,5
P1V-S020AD032	186	79,5
P1V-S020AD018	186	79,5
P1V-S020AD005	202	95,5
P1V-S020AD002	202	95,5
P1V-S020AD001	218	111,5
P1V-S020AD0005	218	111,5

Flange

P1V-S4020B

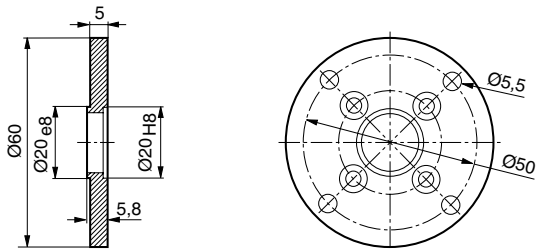

Foot bracket

P1V-S4020F

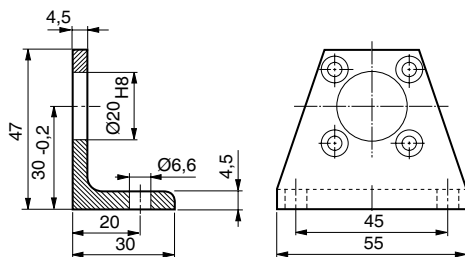

NOTE! All technical data are based on a working pressure of 6 bar and with oil. For oil-free performances are -10 to 15% lower. Data tolerance accuracy +-10%



IMPORTANT! Non Atex certified

Data for reversible brake motor with keyed shaft, P1V-S030AD series

Max power	Free speed*	Nominal speed	Nominal torque	Min start torque	Air consumption at max power	Conn.	Min pipe ID	Weight	Order code
kW	rpm	rpm	Nm	Nm	l/s		mm	Kg	
0,300	14500	7250	0,40	0,60	8,0	G1/4	10	1,350	P1V-S030ADE50
0,300	4600	2300	1,20	1,90	8,0	G1/4	10	1,400	P1V-S030AD460
0,300	2400	1200	2,40	3,60	8,0	G1/4	10	1,400	P1V-S030AD240
0,300	1400	700	4,10	6,10	8,0	G1/4	10	1,450	P1V-S030AD140
0,300	600	300	9,60	14,30	8,0	G1/4	10	1,500	P1V-S030AD060
0,300	340	170	16,90	25,30	8,0	G1/4	10	1,500	P1V-S030AD034
0,300	230	115	24,00	36**	8,0	G1/4	10	3,650	P1V-S030AD023
0,130	180	90	13,80	21,00	4,7	G1/4	10	1,150	P1V-S030AD018
0,300	100	50	57,00	85,50	8,0	G1/4	10	3,650	P1V-S030AD010
0,280	50	25	36**	36**	8,0	G1/4	10	1,600	P1V-S030AD005

** Max permitted torque to not damage the gearbox.

* maximum admissible speed (idling)

The P1V-S030D with threaded shaft may be reversed, but when operated anticlockwise, there is a risk that the driven unit may disconnect if it is not locked properly.

P1V-S030ADE50

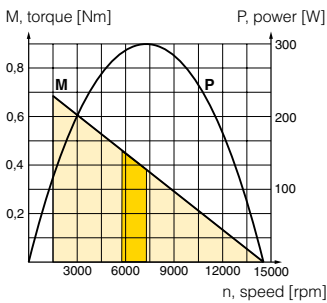

P1V-S030AD460

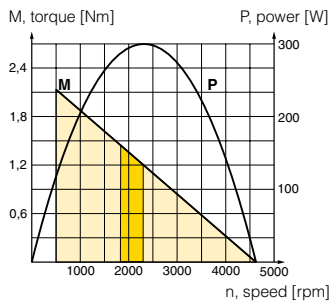

P1V-S030AD240

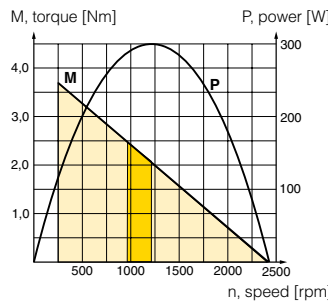

P1V-S030AD140

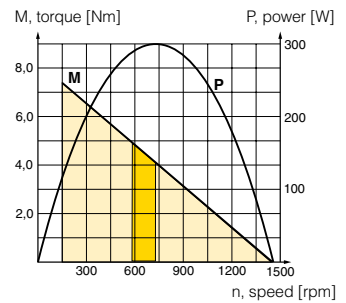

P1V-S030AD060

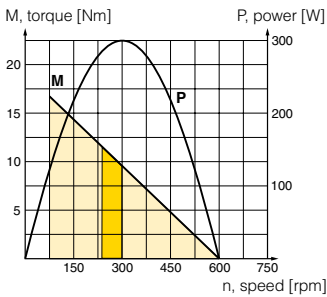

P1V-S030AD034

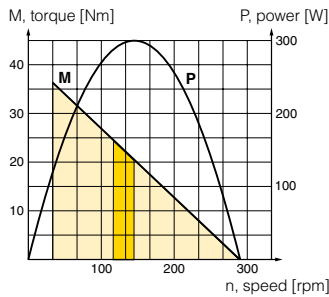

P1V-S030AD023

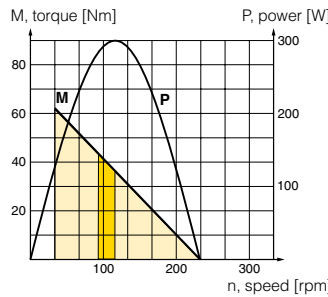

P1V-S030AD018

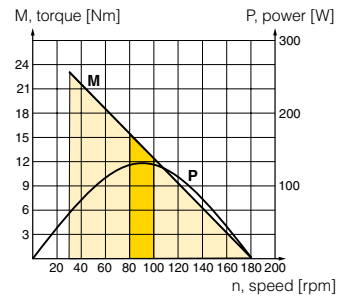

P1V-S030AD010

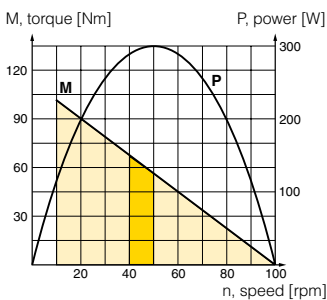

P1V-S030AD005

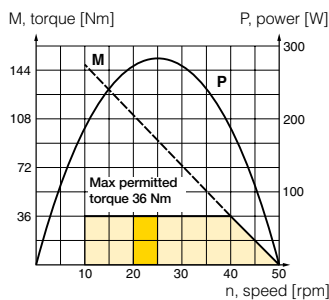

Possible working range of motor.
 Optimum working range of motor.
 Higher speeds = more vane wear
 Lower speeds with high torque = more gearbox wear

Dimensions (mm)

Brake motor P1V-S030

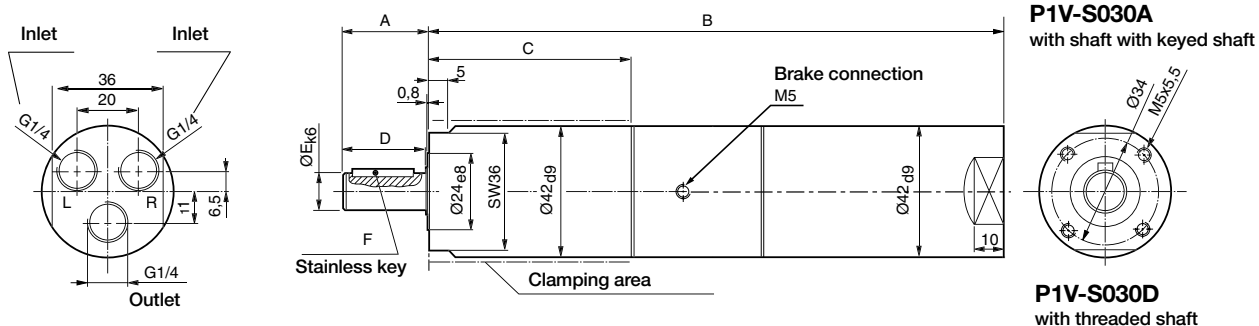

	A	B	C	D	E	F
P1V-S030ADE50	28,5	186	66	27	12	A4x4x20 DIN 6885
P1V-S030AD460	28,5	186	66	27	12	A4x4x20 DIN 6885
P1V-S030AD240	28,5	186	66	27	12	A4x4x20 DIN 6885
P1V-S030AD140	28,5	202	82	27	12	A4x4x20 DIN 6885
P1V-S030AD060	32,0	202	82	30	14	A5x5x20 DIN 6885
P1V-S030AD034	32,0	202	82	30	14	A5x5x20 DIN 6885
P1V-S030AD018	32,0	202	82	30	14	A5x5x20 DIN 6885
P1V-S030AD005	32,0	207	82	30	14	A5x5x20 DIN 6885

Flange

P1V-S4030B

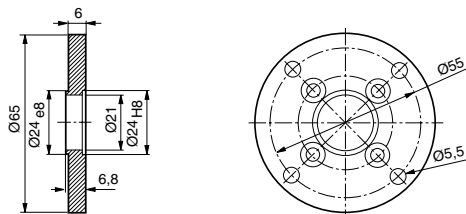

Foot bracket

P1V-S4030F

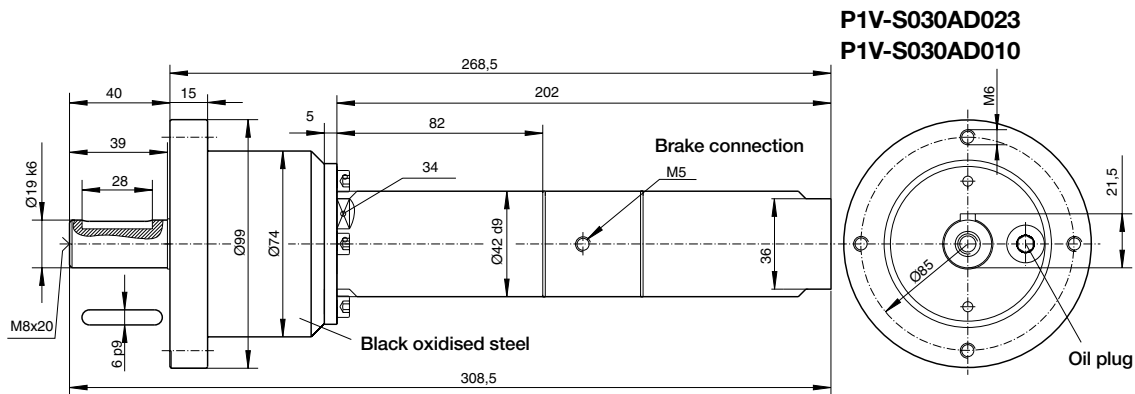
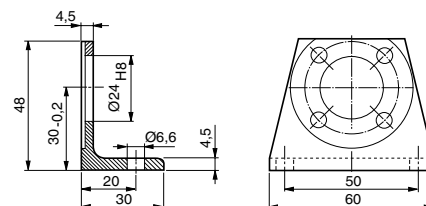

Foot bracket for motors

P1V-S030AD0023 and P1V-S030AD0010

P1V-S4020C

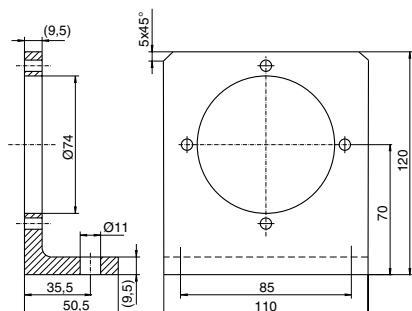

NOTE! All technical data are based on a working pressure of 6 bar and with oil. For oil-free performances are -10 to 15% lower. Data tolerance accuracy +-10%

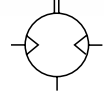

IMPORTANT! Non Atex certified

Data for reversible brake motor with keyed shaft, P1V-S120AD series

Max power	Free speed*	Nominal speed	Nominal torque	Min start torque	Air consumption at max power	Conn.	Min pipe ID	Weight	Order code
kW	rpm	rpm	Nm	Nm	l/s		mm	Kg	
1,200	9000	4500	2,50	3,80	26,7	G3/4	19	9,000	P1V-S120AD900
1,200	2500	1250	9,20	13,70	26,7	G3/4	19	9,200	P1V-S120AD250
1,200	1100	550	21,00	31,00	26,7	G3/4	19	9,200	P1V-S120AD110
1,200	700	350	33,00	49,00	26,7	G3/4	19	9,700	P1V-S120AD070
1,200	320	160	71,00	107,00	26,7	G3/4	19	9,700	P1V-S120AD032

* maximum admissible speed (idling)

P1V-S120AD900

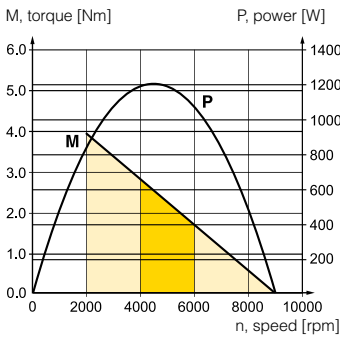

P1V-S120AD250

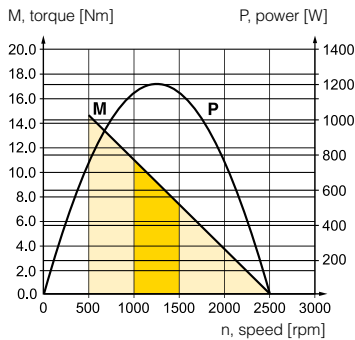

P1V-S120AD110

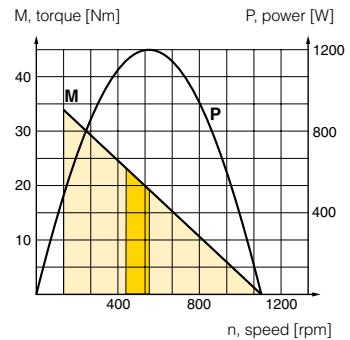

P1V-S120AD070

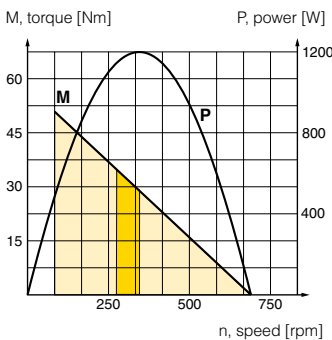

P1V-S120AD032

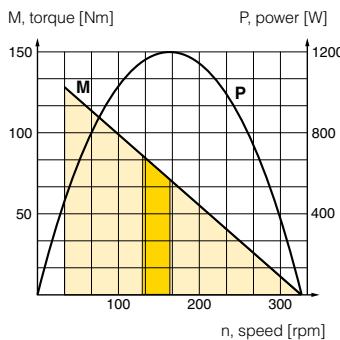

Possible working range of motor.

Optimum working range of motor.
Higher speeds = more vane wear
Lower speeds with high torque = more gearbox wear

Dimensions (mm)

Brake motor P1V-S120

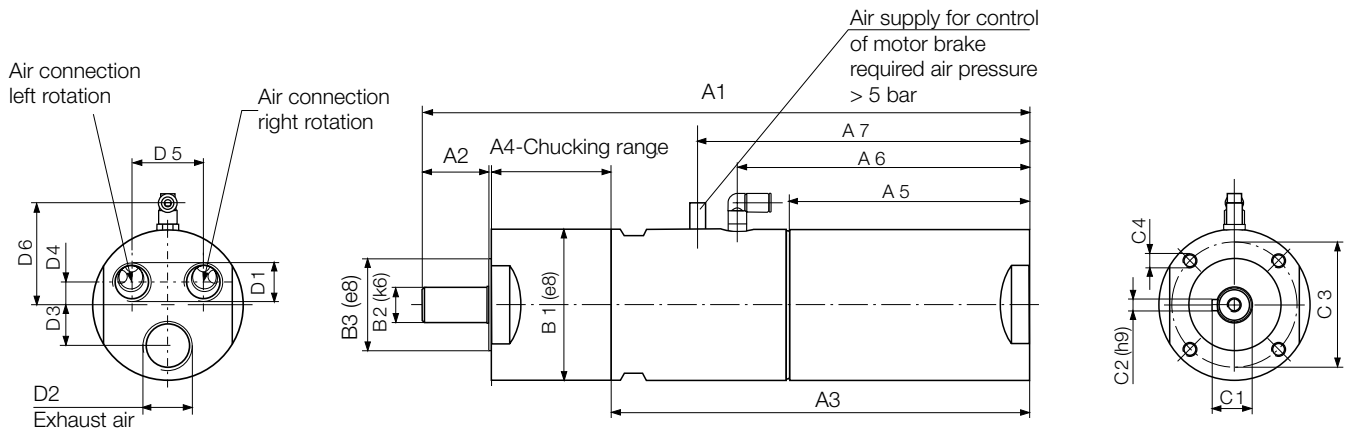

	A	B	C	D	E	F
P1V-S120AD900	28,5	186	66	27	12	A4x4x20 DIN 6885
P1V-S120AD250	28,5	186	66	27	12	A4x4x20 DIN 6885
P1V-S120AD110	28,5	186	66	27	12	A4x4x20 DIN 6885
P1V-S120AD070	28,5	202	82	27	12	A4x4x20 DIN 6885
P1V-S120AD032	32,0	202	82	30	14	A5x5x20 DIN 6885

Flange

P1V-S4120B

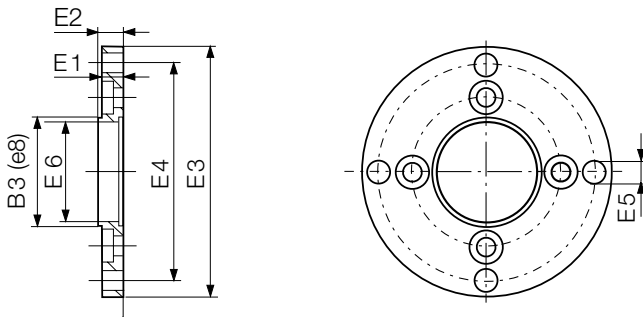

Foot bracket

P1V-S4120F

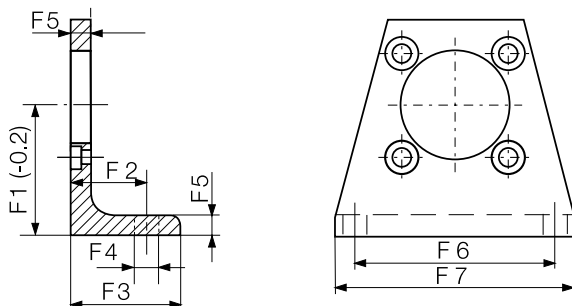



Air Motors

P1V-S, Stainless Steel High Torque Type
285, 570 & 860 Watts

Contents	Page
Technical data	49
Material specification	49
Stainless Steel High Torque Air Motors P1V-S 285 W	50
Dimensions	51
Stainless Steel High Torque Air Motors P1V-S 570 W	52
Dimensions	53
Stainless Steel High Torque Air Motors P1V-S 860 W	54
Dimensions	55
Mountings	56
Lubrication and service life	57
Service kits	58 - 59
Introduction to the ATEX directive	60 - 64

Technical data

Air motor size & type	P1V-S028	P1V-S057	P1V-S086
Nominal power (watts)	285	570	860
Working pressure (bar)	3 to 7, 6 in explosive atmosphere (high torque not atex certified)		
Working temperature (°C)	-20 to +110		
Ambient temperature (°C)	-20 to +40 in explosive atmosphere (high torque not atex certified)		
Air flow required (l/min)	470	850	1400
Min pipe ID, inlet (mm)	10	12	12
Min pipe ID, outlet (mm)	10	12	12

Choice of treatment unit: recommended min air flow (l/min) at p1 7.5 bar and 0.8 bar pressure drop

	510	900	1500
Medium	40µm filtered, oil mist or dry unlubricated compressed air		
Oil free operation, indoor	ISO8573-1 purity class 3.4.1		
Oil free operation, outdoor	ISO8573-1 purity class 1.2.1		
Oil operation	1-2 drop per cube meter, ISO8573-1 purity class 3.-.5		
Recommended oil	Foodstuffs industry Klüber oil 4 UH1- 32 N		

Choice of valve: recommended min nominal air flow (l/min) at p1 6 bar and 1 bar pressure drop

	550	950	1600
Sound level free outlet (dB(A))	103	103	106
With outlet silencer (dB(A))	91	94	88
Exhaust air removed with pipes to another room	70	76	80

Note: sound levels are measured at free speed with the measuring instrument positioned 1 meter away from the air motor at an height of 1 meter.

Table and diagram data

All technical data are based on a working pressure of 6 bar and with oil. Oil-free performances are -10 to 15% lower. Data tolerance accuracy +-10%

Material specification

Air motor size & type	P1V-S028	P1V-S057	P1V-S086
Planetary gearbox housing	Stainless steel		
Air motor housing	Stainless steel		
Shaft	Hardened stainless steel		
Key	Hardened stainless steel		
External seal Fluor rubber	Fluor rubber FPM		
Internal steel parts	High grade steel (not stainless)		
Planetary gear grease used in	Grease, Shell Cassida RLS2		
Screws in housing in last planet stage	Surface treated steel (not stainless)		

Accessories	P1V
Flange bracket	Stainless steel
Foot bracket	Stainless steel
Screws for the mountings	Stainless steel DIN A2

The high torque motors of the P1V-S type are small in size but provide extremely high output. Our high torque motors are also less apt to stall. These drive solutions are Particularly suitable for use in industrial agitators and mixers as used in the paint industry, food industry or pharmaceutical industry.

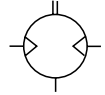

NOTE! All technical data are based on a working pressure of 6 bar and with oil. For oil-free performances are -10 to 15% lower. Data tolerance accuracy +-10%



Data for reversible air motor with keyed shaft, P1V-S028A series

Max power	Free speed*	Nominal speed	Nominal torque	Min start torque	Air consumption at max power	Conn.	Min pipe ID	Weight	Order code
kW	rpm	rpm	Nm	Nm	l/s		mm	Kg	
0,285	170	85	32	47	7,8	G3/8	10	2,700	P1V-S028A0017
0,285	80	40	62	92	7,8	G3/8	10	2,600	P1V-S028A0008
0,285	50	25	110	162	7,8	G3/8	10	2,900	P1V-S028A0005
0,280	26	13	210	320	7,8	G3/8	10	3,500	P1V-S028A0003
0,280	14	7	410	615	7,8	G3/8	10	3,500	P1V-S028A0002

* maximum admissible speed (idling)

P1V-S028A0017

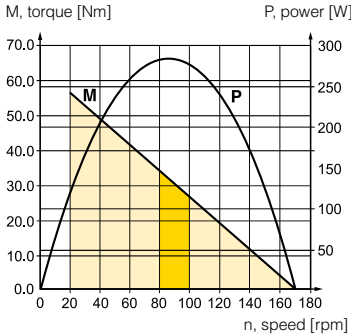

P1V-S028A0008

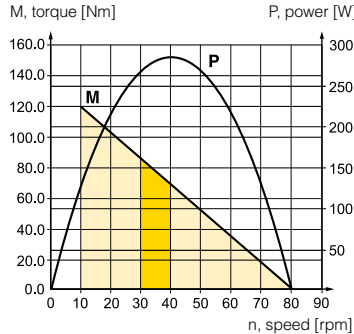

P1V-S028A00005

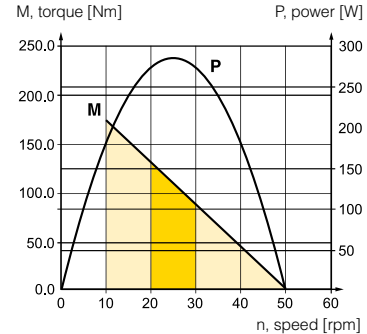

P1V-S028A00003

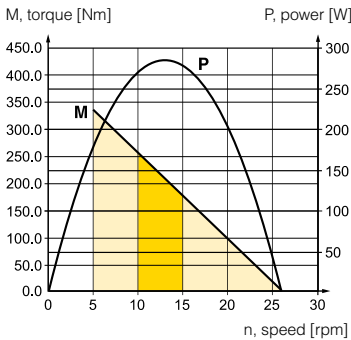

P1V-S028A00002

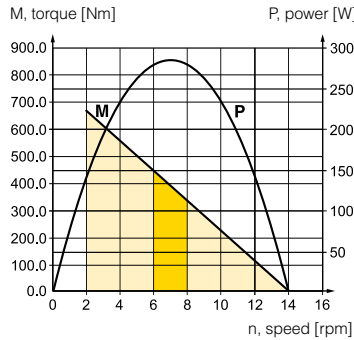

- Possible working range of motor.
 - Optimum working range of motor.
- Higher speeds = more vane wear
Lower speeds with high torque = more gearbox wear

Dimensions (mm)

High Torque Motor P1V-S028

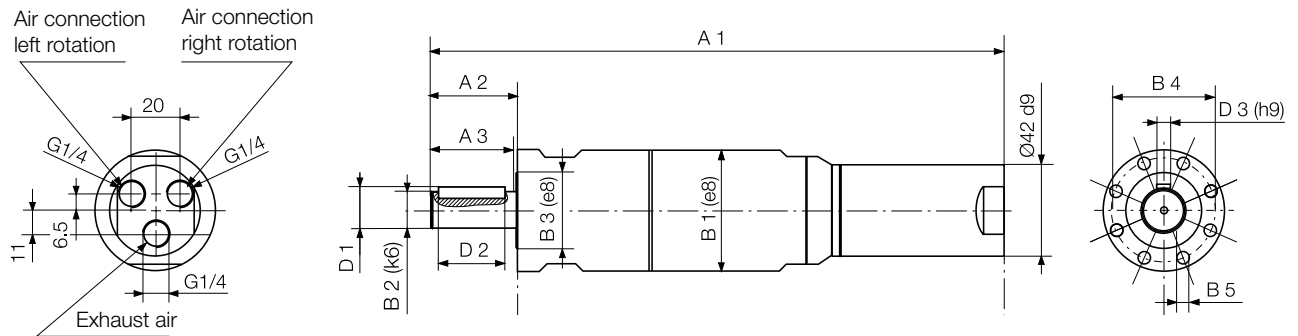

	A1	A2	A3	D1	D2	D3 (h9)	B1 (e8)	B2 (k6)	B3	B4	B5
P1V-S028A0017	254	44	42	21.5	32	A6x6x32 DIN6885	56	19	35	48	M6
P1V-S028A0008	254	44	42	21.5	32	A6x6x32 DIN6885	56	19	35	48	M6
P1V-S028A0005	270	44	42	21.5	32	A6x6x32 DIN6885	56	19	35	48	M6
P1V-S028A0003	270	47	45	27	32	A6x6x32 DIN6885	63	24	34	45	M8
P1V-S028A0002	279	47	45	27	32	A6x6x32 DIN6885	63	24	34	45	M8

Flange

P1V-S4028B1 & B2

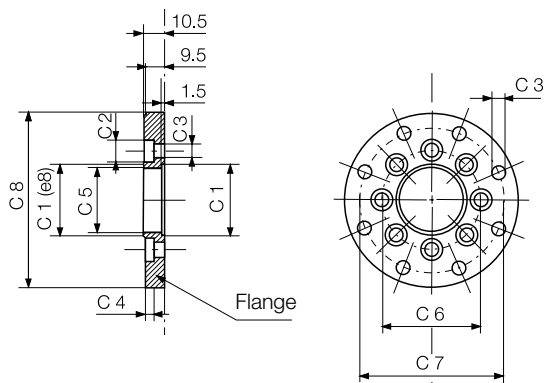

Foot bracket

P1V-S4028F1 & F2

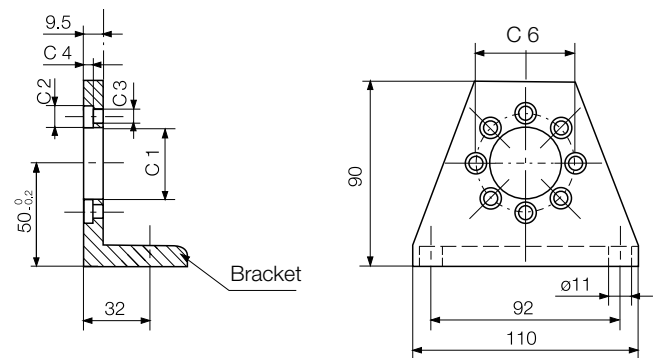

	c1 (e8)	C2	C3	C4	C5	C6	C7	C8
P1V-S028F1	35	11	6.6	4		48	70	
P1V-S028F2	34	13	8.4	5		45	79	
P1V-S028B1	35	11	6.6	4	32	48	70	85
P1V-S028B2	34	13	8.4	5	30	45	79	95

The high torque motors of the P1V-S type are small in size but provide extremely high output. Our high torque motors are also less apt to stall. These drive solutions are Particularly suitable for use in industrial agitators and mixers as used in the paint industry, food industry or pharmaceutical industry.

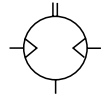

NOTE! All technical data are based on a working pressure of 6 bar and with oil. For oil-free performances are -10 to 15% lower. Data tolerance accuracy +-10%



Data for reversible air motor with keyed shaft, P1V-S057A series

Max power	Free speed*	Nominal speed	Nominal torque	Min start torque	Air consumption at max power	Conn.	Min pipe ID	Weight	Order code
kW	rpm	rpm	Nm	Nm	l/s		mm	Kg	
0,570	150	75	72	108	14,2	G1/2	10	3,600	P1V-S057A0015
0,570	110	55	98	147	14,2	G1/2	10	3,600	P1V-S057A0011
0,570	74	37	150	225	14,2	G1/2	10	3,600	P1V-S057A0007
0,565	40	20	265	400	14,2	G1/2	10	4,400	P1V-S057A0004

* maximum admissible speed (idling)

P1V-S057A0015

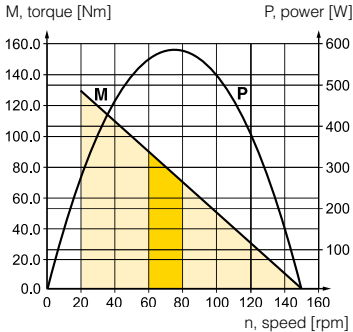

P1V-S057A0011

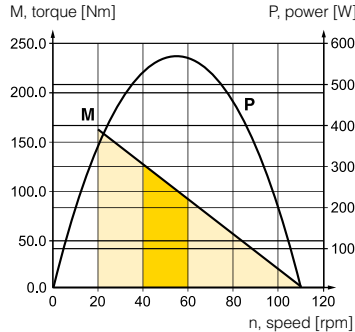

P1V-S057A0007

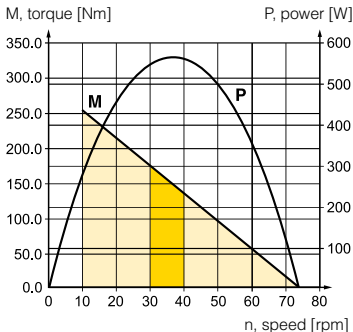

P1V-S057A0004

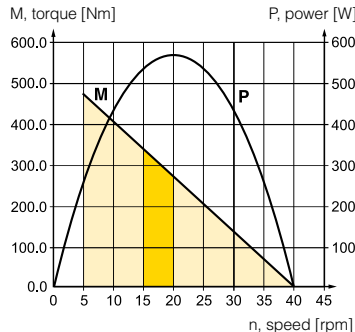

- Possible working range of motor.
 - Optimum working range of motor.
- Higher speeds = more vane wear
Lower speeds with high torque = more gearbox wear

Dimensions (mm)

High Torque Motor P1V-S057

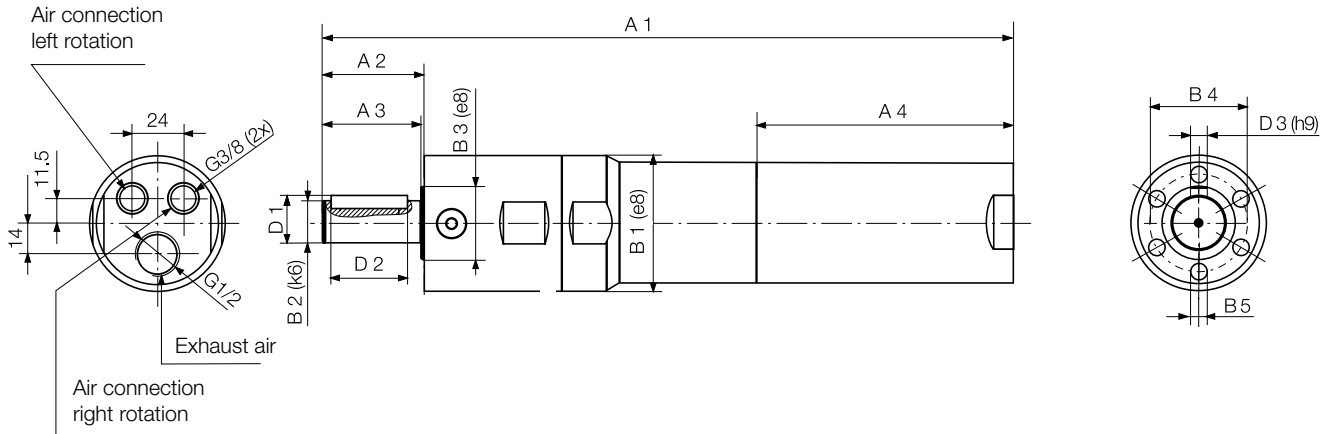

	A1	A2	A3	A4	D1	D3 (h9)	D2	B1 (e8)	B2 (k6)	B3 (e8)	B4	B5
P1V-S057A0015	283.5	44	42	98.5	21.5	A6x6x32 DIN6885	32	56	19	35	48	M6
P1V-S057A0011	283.5	44	42	98.5	21.5	A6x6x32 DIN6885	32	56	19	35	48	M6
P1V-S057A0007	283.5	44	42	98.5	21.5	A6x6x32 DIN6885	32	56	19	35	48	M6
P1V-S057A0004	347	47	45	98.5	27	A6x6x32 DIN6885	32	63	24	34	45	M8

Flange

P1V-S4028B1 & B2

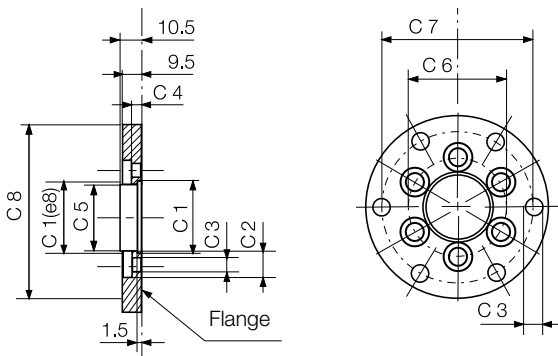

Foot bracket

P1V-S4028F1 & F2

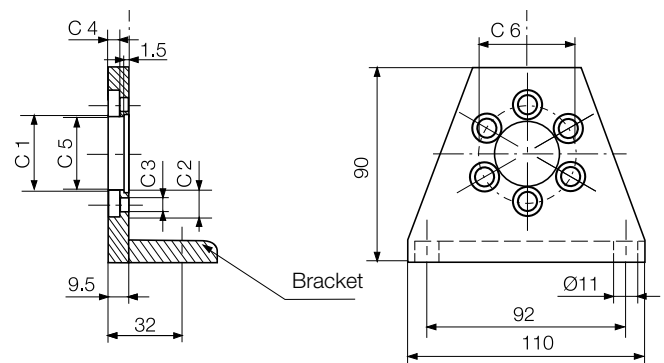

	c1 (e8)	C2	C3	C4	C5	C6	C7	C8
P1V-S028F1	35	11	6.6	4		48	70	
P1V-S028F2	34	13	8.4	5		45	79	
P1V-S028B1	35	11	6.6	4	32	48	70	85
P1V-S028B2	34	13	8.4	5	30	45	79	95

The high torque motors of the P1V-S type are small in size but provide extremely high output. Our high torque motors are also less apt to stall. These drive solutions are Particularly suitable for use in industrial agitators and mixers as used in the paint industry, food industry or pharmaceutical industry.



NOTE! All technical data are based on a working pressure of 6 bar and with oil. For oil-free performances are -10 to 15% lower. Data tolerance accuracy +-10%

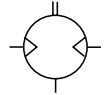

Data for reversible air motor with keyed shaft, P1V-S086A series

Max power	Free speed*	Nominal speed	Nominal torque	Min start torque	Air consumption at max power	Conn.	Min pipe ID	Weight	Order code
kW	rpm	rpm	Nm	Nm	l/s		mm	Kg	
0,860	150	75	160	110	23,3	G1/2	10	3,800	P1V-S086A0015
0,860	110	55	220	150	23,3	G1/2	10	3,900	P1V-S086A0011
0,860	70	35	335	225	23,3	G1/2	10	3,900	P1V-S086A0007
0,850	40	20	600	400	23,3	G1/2	10	4,700	P1V-S086A0004

* maximum admissible speed (idling)

P1V-S086A0015

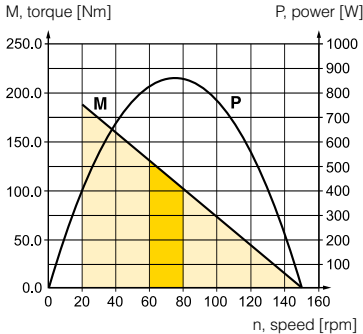

P1V-S086A0011

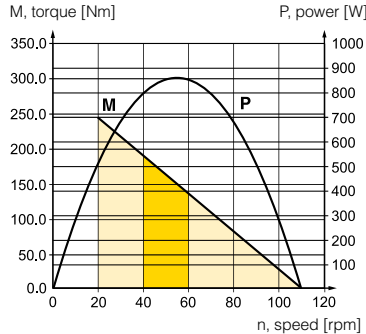

P1V-S086A0007

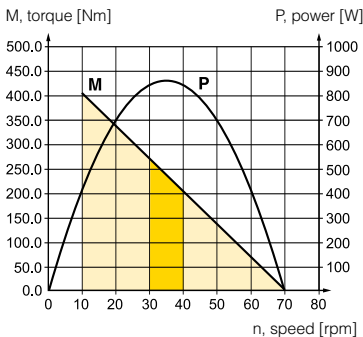

P1V-S086A0004

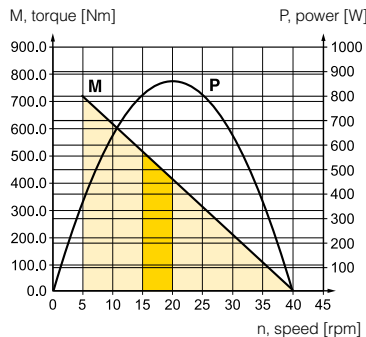

Possible working range of motor.

Optimum working range of motor.

Higher speeds = more vane wear
Lower speeds with high torque = more gearbox wear

Dimensions (mm)

High Torque Motor P1V-S086

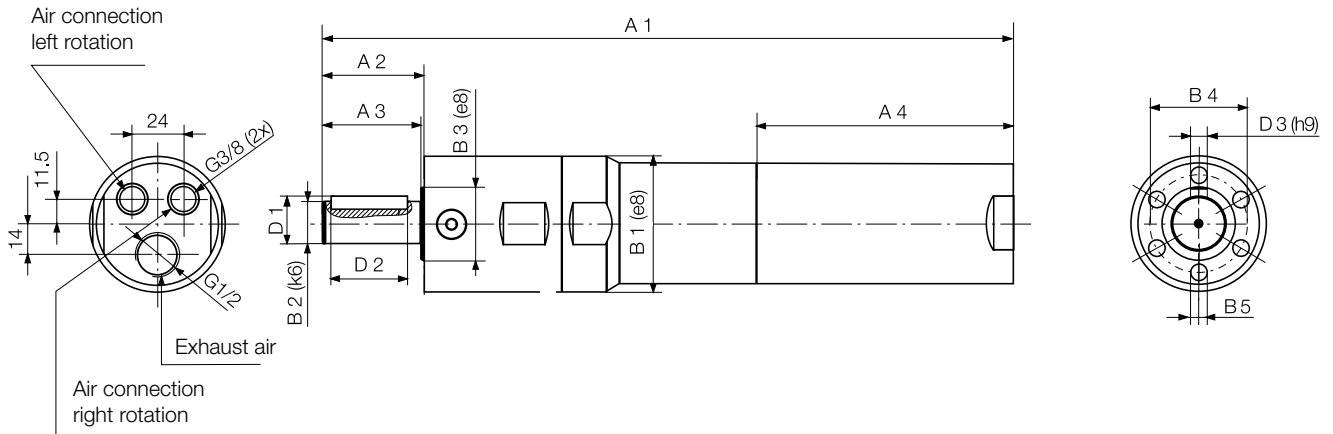

	A1	A2	A3	A4	D1	D3 (h9)	D2	B1 (e8)	B2 (k6)	B3 (e8)	B4	B5
P1V-S086A0015	303.5	44	42	118.5	21.5	A6x6x32 DIN6885	32	56	19	35	48	M6
P1V-S086A0011	303.5	44	42	118.5	21.5	A6x6x32 DIN6885	32	56	19	35	48	M6
P1V-S086A0007	303.5	44	42	118.5	21.5	A6x6x32 DIN6885	32	56	19	35	48	M6
P1V-S086A0004	320	47	45	98.5	27	A6x6x32 DIN6885	32	63	24	34	45	M8

Flange

P1V-S4028B1 & B2

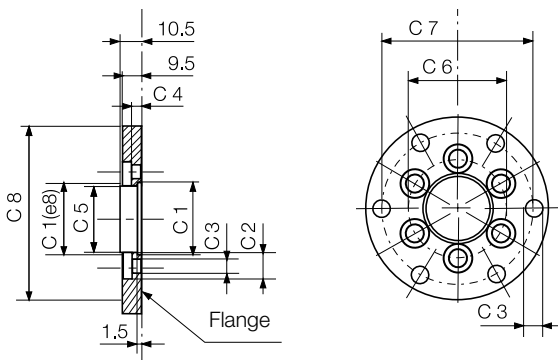

Foot bracket

P1V-S4028F1 & F2

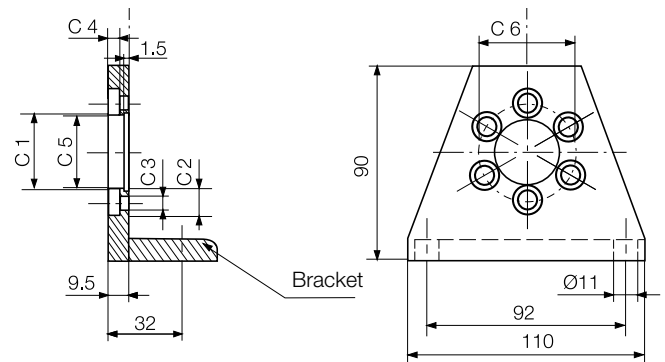

	c1 (e8)	C2	C3	C4	C5	C6	C7	C8
P1V-S028F1	35	11	6.6	4		48	70	
P1V-S028F2	34	13	8.4	5		45	79	
P1V-S028B1	35	11	6.6	4	32	48	70	85
P1V-S028B2	34	13	8.4	5	30	45	79	95

Mountings for P1V-S air motors

Type	For air motor	Weight Kg	Order code
------	---------------	--------------	------------

Flange

P1V-S002 & P1V-S003		0,04	P1V-S4002B
P1V-S008		0,04	P1V-S4008B
P1V-S012		0,05	P1V-S4012B
P1V-S020		0,09	P1V-S4020B
P1V-S028 high torque		0,10	P1V-S4028B1
P1V-S028 high torque		0,10	P1V-S4028B2
P1V-S030		0,12	P1V-S4030B
P1V-S057 high torque		0,30	P1V-S4028B1
P1V-S057 high torque		0,30	P1V-S4028B2
P1V-S060 & P1V-S090		0,30	P1V-S4060B
P1V-S086 high torque		0,30	P1V-S4028B1
P1V-S086 high torque		0,30	P1V-S4028B2
P1V-S120		0,60	P1V-S4120B

Foot bracket

P1V-S008		0,08	P1V-S4008F
P1V-S012		0,09	P1V-S4012F
P1V-S020		0,11	P1V-S4020F
P1V-S028 high torque		0,11	P1V-S4028F1
P1V-S028 high torque		0,11	P1V-S4028F2
P1V-S030A0023		0,55	P1V-S4020C
P1V-S030A0010		0,55	P1V-S4020C
P1V-S030		0,11	P1V-S4030F
P1V-S057 high torque		0,30	P1V-S4028F1
P1V-S057 high torque		0,30	P1V-S4028F2
P1V-S060 & P1V-S090		0,30	P1V-S4060F
P1V-S086 high torque		0,30	P1V-S4028F1
P1V-S086 high torque		0,30	P1V-S4028F2
P1V-S120		0,80	P1V-S4120F

All brackets supplied with fastening screws for the motor.

P1V-S - Stainless Steel Air Motors

Lubrication and service life



The first service is due after approximately 500 hours of operation. After the first service, the service interval is determined by the degree of vane wear*. The table below shows new dimensions and the minimum dimensions of worn vanes.

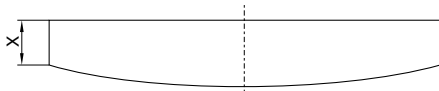

Air motor	Dimensions on new vanes X (mm), type of vanes			
	Standard	Z	C	M
P1V-S002	3,3	-	-	-
P1V-S003	X	-	-	-
P1V-S008	4,3	-	-	-
P1V-S012	4,2	4,2	4,2	4,2
P1V-S020	6,5	6,0	6,0	6,0
P1V-S028	X	X	X	X
P1V-S030	6,8	6,2	6,8	6,2
P1V-S057	X	X	X	X
P1V-S060	9,0	9,0	9,0	9,0
P1V-S086	X	X	X	X
P1V-S090	X	X	X	X
P1V-S120	14,7	14,0	14,0	14,0

Air motor	Dimensions on vanes X (mm), type of vanes			
	Standard	Z	C	M
P1V-S002	3,0	-	-	-
P1V-S003	X	-	-	-
P1V-S008	4,0	-	-	-
P1V-S012	3,3	3,3	3,3	3,3
P1V-S020	5,8	5,3	5,3	5,3
P1V-S028	X	X	X	X
P1V-S030	6,0	5,2	6,0	5,2
P1V-S057	X	X	X	X
P1V-S060	6,0	6,0	6,0	6,0
P1V-S086	X	X	X	X
P1V-S090	X	X	X	X
P1V-S120	14,2	13,5	13,5	13,5

The following normal service intervals should be applied to in order to guarantee problem-free operation in air motors working continuously at load speeds.

Intermittent lubrication-free operation of motors with standard vanes, option 0

Duty cycle : 70%
 Max. duration of intermittent use : 15 minutes
 Filtering 40 µm : 750 hours of operation*
 Filtering 5 µm : 1,000 hours of operation*

Continuous lubricated operation of motors with standard vanes, option 0

Duty cycle : Continuous
 Quantity of oil : 1 drop per m³ of air
 Filtering 40 µm : 1,000 hours of operation*
 Filtering 5 µm : 2,000 hours of operation*

Note! After 1000 hours of operation, the grease in the planetary gearbox must be changed

Continuous lubrication-free operation of motors equipped with vanes, option C

Duty cycle : Continuous
 Filtering 40 µm : 750 hours of operation*
 Filtering 5 µm : 1,000 hours of operation*



* The specified hours of operation apply when the motor is running at the speed corresponding to maximum power (load speed). This is approximately half free speed. If the motor operates at higher speeds, the service interval is shorter. If the motor operates at lower speeds, the service interval is longer.

P1V-S - Stainless Steel Air Motors

Service kits

The following kits are available for the basic motors, consisting of vanes, (springs), silencers, O-rings, seals and 50 g of grease. (USDA-H1 approved)

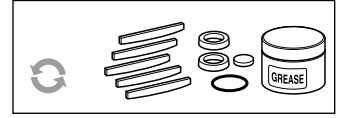
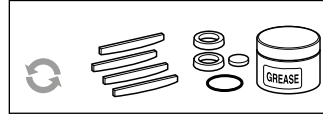
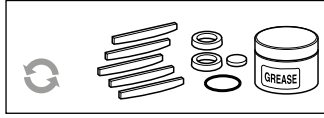
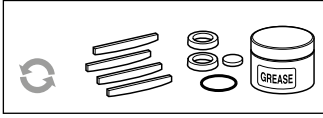

Optional function "0" and "D"

Service kits, vanes for intermittent lubrication-free operation

For motors	Order code
P1V-S002A	P1V-6/446083A
P1V-S003A	P1V-6/446083A
P1V-S008A	P1V-6/446084A
P1V-S012A0 / D0 (to serial no 948688)	9121720601
P1V-S012A0 / D0 (from serial no 948689)	9121720636
P1V-S020A• / D•	9121720602
P1V-S030A• / D•	9121720603
P1V-S060A0E00	9121720604
P1V-S060A0400	9121720604
P1V-S060A0350	9121720604
P1V-S060A0270	9121720604
P1V-S060A0170	9121720604
P1V-S060A0072	9121720604
P1V-S060A0063	9121720604
P1V-S060A0048	9121720605
P1V-S060A0030	9121720605
P1V-S060A0015	9121720605
P1V-S060A0010	9121720605
P1V-S090A0C00	P1V-6/444919A
P1V-S090A0350	P1V-6/444919A
P1V-S090A0270	P1V-6/444919A
P1V-S090A0170	P1V-6/444919A
P1V-S090A0063	P1V-6/444919A
P1V-S090A0048	P1V-6/444919B
P1V-S090A0030	P1V-6/444919B
P1V-S120A•800	9121720606
P1V-S120A•270	9121720606
P1V-S120A•110	9121720606
P1V-S120A•078	9121720607
P1V-S120A•032	9121720607
P1V-S120A•012	9121720607

Optional function "C" and "E"

Service kits, vanes for continuous lubrication-free operation

For motors	Order code
P1V-S012AC / DC (to serial no 948688)	9121720608
P1V-S012AC / DC (from serial no 948689)	9121720637
P1V-S020A• / D•	9121720609
P1V-S030A• / D•	9121720610
P1V-S060ACE00	9121720611
P1V-S060AC400	9121720611
P1V-S060AC350	9121720611
P1V-S060AC270	9121720611
P1V-S060AC170	9121720611
P1V-S060AC072	9121720611
P1V-S060AC063	9121720611
P1V-S060AC048	9121720612
P1V-S060AC030	9121720612
P1V-S060AC015	9121720612
P1V-S060AC010	9121720612
P1V-S090ACC00	On request
P1V-S090AC350	On request
P1V-S090AC270	On request
P1V-S090AC170	On request
P1V-S090AC063	On request
P1V-S090AC048	On request
P1V-S090AC030	On request
P1V-S120A•800	9121720613
P1V-S120A•270	9121720613
P1V-S120A•110	9121720613
P1V-S120A•078	9121720614
P1V-S120A•032	9121720614
P1V-S120A•012	9121720614

• : 0 or D, C or E

Service kits for high torque motors

For motors	Order code
P1V-S028A0017	P1V-6/4447861B
P1V-S028A0008	P1V-6/4447861B
P1V-S028A0005	P1V-6/4447861B
P1V-S028A0003	P1V-6/4447861C
P1V-S028A0002	P1V-6/4447861C
P1V-S057A0015	P1V-6/4447871D
P1V-S057A0011	P1V-6/4447871D
P1V-S057A0007	P1V-6/4447871D
P1V-S057A0004	P1V-6/4447871E
P1V-S086A0015	P1V-6/4449191C
P1V-S086A0011	P1V-6/4449191C
P1V-S086A0007	P1V-6/4449191C
P1V-S086A0004	P1V-6/4449191D

P1V-S - Stainless Steel Air Motors

Service kits

The following kits are available for the basic motors, consisting of vanes, (springs), silencers, O-rings, seals and 50 g of grease. (USDA-H1 approved)

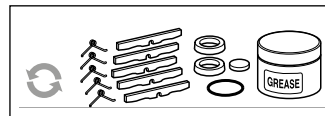
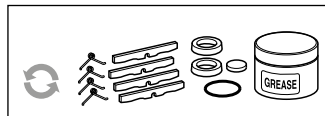
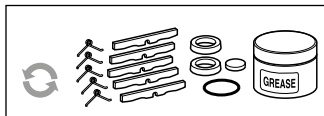
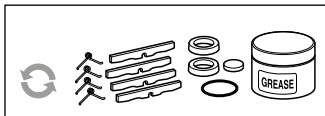

Optional function "Z" and "F"

Service kits, spring-loaded vanes for intermittent lubrication-free operation

For motors	Order code
P1V-S012AZ / DZ (to serial no 948688)	9121720615
P1V-S012AZ / DZ (from serial no 948689)	9121720638
P1V-S020A• / D•	9121720616
P1V-S030A• / D•	9121720617
P1V-S060AZE00	9121720618
P1V-S060AZ400	9121720618
P1V-S060AZ350	9121720618
P1V-S060AZ270	9121720618
P1V-S060AZ170	9121720618
P1V-S060AZ072	9121720618
P1V-S060AZ048	9121720619
P1V-S060AZ072	9121720619
P1V-S060AZ063	9121720619
P1V-S060AZ010	9121720619
P1V-S090AZC00	On request
P1V-S090AZ350	On request
P1V-S090AZ270	On request
P1V-S090AZ170	On request
P1V-S090AZ063	On request
P1V-S090AZ048	On request
P1V-S090AZ030	On request
P1V-S120A•800	9121720620
P1V-S120A•270	9121720620
P1V-S120A•110	9121720620
P1V-S120A•078	9121720621
P1V-S120A•032	9121720621
P1V-S120A•012	9121720621

• : Z or F, M or G

Optional function "M" and "G"

Service kits, spring-loaded vanes for continuous lubrication-free operation

For motors	Order code
P1V-S012AM / DM (to serial no 948688)	9121720622
P1V-S012AM / DM (from serial no 948689)	9121720639
P1V-S020A• / D•	9121720623
P1V-S030A• / D•	9121720624
P1V-S060AME00	9121720625
P1V-S060AM400	9121720625
P1V-S060AM270	9121720625
P1V-S060AM170	9121720625
P1V-S060AM072	9121720625
P1V-S060AM048	9121720626
P1V-S060AM030	9121720626
P1V-S060AM010	9121720626
P1V-S090AMC00	On request
P1V-S090AM350	On request
P1V-S090AM270	On request
P1V-S090AM170	On request
P1V-S090AM063	On request
P1V-S090AM048	On request
P1V-S090AM030	On request
P1V-S120A•800	9121720627
P1V-S120A•270	9121720627
P1V-S120A•110	9121720627
P1V-S120A•078	9121720628
P1V-S120A•032	9121720628
P1V-S120A•012	9121720628

Service kits for brake module for motors with brakes

For motors	Order code
P1V-S020AD and P1V-S030AD	P1V-6/446096A
P1V-S120AD	P1V-6/4460961B

Comment: To perform a full service on a brake motor, you will need a normal service kit as well as a service kit for the brake module.

Introduction to the ATEX directive

Explosive atmospheres

Directive 94/9/EC defines an explosive atmosphere as a mixture of:

- a) **flammable substances** – gases, vapours, mists or dusts
- b) with **air**
- c) under specific **atmospheric conditions**
- d) in which, after ignition has occurred, combustion spreads to the entire flammable mixture

(NB: with regard to dust, it may be that not all dust is combusted after ignition has occurred)

An atmosphere with the potential to become an explosive atmosphere during operating conditions and/or under the influence of the surroundings is defined as a **potentially explosive atmosphere**. Products covered by directive 94/9/EC are defined as intended for use in potentially explosive atmospheres.

Harmonised European ATEX standard

The European Union has adopted two harmonised directives in the field of health and safety. The directives are known as ATEX 100a and ATEX 137.

Directive ATEX 100a (94/9/EC) lays down minimum safety requirements for products intended for use in potentially explosive atmospheres in European Union member states. Directive ATEX 137 (99/92/EC) defines minimum requirements for health and safety at the workplace, for working conditions and for the handling of products and materials in potentially explosive atmospheres. This directive also divides the workplace into **zones** and defines criteria by which products are **categorised** within these zones.

The table below describes the **zones** in an installation where there is a potential for explosive atmospheres. The **owner** of the installation must analyse and assess the area in which the explosive gas/dust mixture may occur, and if necessary must divide it into **zones**. This process of zoning then allows the correct plant and equipment to be selected for use in the area.

The ATEX directive has been in force throughout the European Union

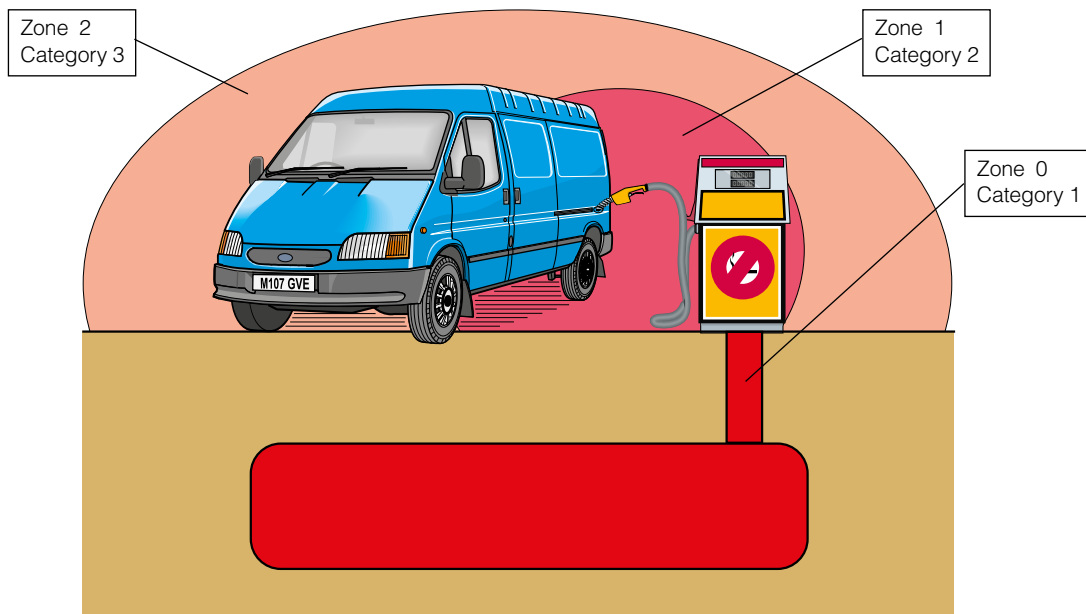

Zones		Presence of potentially explosive atmosphere	Type of risk
Gas G	Dust D		
0	20	Present continuously or for long periods	Permanent
1	21	Likely to occur in normal operation occasionally	Potential
2	22	Not likely to occur in normal operation but, if it does occur, will persist for a short period only	Minimal

since 1 July 2003, replacing the existing divergent national and European legislation relating to explosive atmospheres. Please note that for the first time, the directive covers mechanical, hydraulic and pneumatic equipment and not just electrical equipment as before.

With regard to the **Machinery directive** 98/37/EC, note that a number

of external requirements in 94/9/EC refer to hazards arising from potentially explosive atmospheres, where the Machinery directive only contains general requirements relating to explosion safety (Annex I 1.5.7).

As a result, directive 94/9/EC (ATEX 100a) takes precedence over the Machinery directive with regard to explosion protection in potentially explosive atmospheres. The requirements in the Machinery directive are applicable to all other risks relating to machinery.

P1V-S - Stainless Steel Air Motors

Levels of protection for the various equipment categories

The various equipment categories must be capable of operating in accordance with the manufacturer's operating specifications at defined levels of protection.

Level of protection	Category		Type of protection	Operating specifications
	Group I	Group II		
Very high	M1		Two independent means of protection or safety, ensuring that the equipment remains functional even in the event of two faults occurring independently of each other	The equipment remains energised and functional even with an explosive atmosphere present
Very high		1	Two independent means of protection or safety, ensuring that the equipment remains functional even in the event of two faults occurring independently of each other	The equipment remains energised and functional in zones 0, 1, 2 (G) and/or zones 20, 21, 22 (D)
High	M2		Protection suitable for normal operation and severe operating conditions	The equipment is de-energised in the event of an explosive atmosphere
High		2	Protection suitable for normal operation and frequent faults, or equipment in which faults normally have to be taken into account	The equipment remains energised and functional in zones 1, 2 (G) and/or zones 21, 22 (D)
Normal		3	Protection suitable for normal operation	The equipment remains energised and functional in zones 2 (G) and/or zones 22 (D)

Definition of groups (EN 1127-1)

Group I Equipment intended for use in underground parts of mines as well as those parts of surface installations of such mines likely to be endangered by flammable vapours and/or flammable dusts.

Group II Equipment intended for use in other places exposed to explosive atmospheres.

Group	I mines, combustible vapours		II other potentially explosive atmospheres (gases, dust)					
	M1	M2	1		2		3	
Category								
Atmosphere*			G	D	G	D	G	D
Zone			0	20	1	21	2	22

G = gas and D = dust

Temperature classes

Classification of flammable gases and vapours on the basis of ignition temperature

Temperature class	Ignition temperature °C
T1	Over 450
T2	(300) – 450
T3	(200) – 300
T4	(135) – 200
T5	(100) – 135
T6	(85) - 100

Declaration of conformity

The product catalogues contain copies of the declaration of conformity demonstrating that the product meets the requirements of directive 94/9/EC.

The declaration is only valid in conjunction with the instructions contained in the installation manual relating to the safe use of the product throughout its service life.

The instructions relating to the conditions in the surrounding area are particularly important, as the certificate is invalidated if the instructions are found not to have been adhered to during operation of the product. If there is any doubt as to the validity of the certificate of conformity, contact Parker Hannifin customer service.

Operation, installation and maintenance

The installation manual of the product contains instructions relating to the safe storage, handling, operation and servicing of the product.

The manual is available in different languages, and can be downloaded from www.parker.com/euro_pneumatic.

This document must be made accessible in a suitable place near where the product is installed. It is used as a reference for all personnel authorised to work with the product throughout its service life.

We, the manufacturer, reserve the right to modify, extend or improve the installation manual in the interests of the users.

For more information about ATEX see EUs homepage: <http://europa.eu.int/comm/enterprise/atex/>



Additional safety instructions for installation in explosive atmospheres

Serious, even fatal, damage or injury may be caused by the hot moving parts of the P1V-S motors in the presence of explosive gas mixtures and concentrations of dust.

All installation, connection, commissioning, servicing and repair work on P1V-S motors must be carried out by qualified personnel taking account of the following

- These instructions
- Notices on the motor
- All other planning documents, commissioning instructions and connection diagrams associated with the application.
- Provisions and requirements specific to the application
- Applicable national/international regulations (explosion protection, safety and accident prevention)

Real life applications

P1V-S motors are designed to provide rotary movement in industrial applications, and should only be used in accordance with the instructions in the technical specifications in the catalogue, and within the operating range indicated on the motor housing. The motors meet the applicable standards and requirements of the Machinery Directive 94/9/EC (ATEX)

The motors must not be used as brakes in explosive atmospheres.

Braking involves driving the motor against the direction of rotation for which the motor is supplied with compressed air. The motor is then operating as a compressor, and there is a corresponding increase in temperature.

The motors must **not** be used underground in mines susceptible to firedamp and/or combustible dust. The motors are intended for use in areas in which explosive atmospheres caused by gases, vapours or mists of combustible liquids, or air/dust mixtures may be expected to occur during normal use (infrequently)

Checklist

Before using the motors in a potentially explosive atmosphere, you should check the following:

Do the motor specifications match the classification of the area of use in accordance with Directive 94/9/EG (previously ATEX 100a)

- Equipment group
 - Equipment category
 - Zone
 - Temperature class
 - Max. surface temperature
1. When installing the motor, is it certain that there is no potentially explosive atmosphere, oil, acids, gases, vapours or radiation?
 2. Is the ambient temperature as specified in the technical data in the catalogue at all times?
 3. Is it certain that the P1V-S motor is adequately ventilated and that no additional heat is added (for example in the shaft connection)?
 4. Are all the driven mechanical components ATEX certified?

Installation requirements in potentially explosive atmospheres

- The temperature of the supply air must not exceed the ambient temperature.
- The P1V-S may be installed in any position.
- An air treatment unit must be attached to the inlet of the P1V-S air motor.
- In a potentially explosive atmosphere, none of the motor ports may be blocked because this may cause an increase in temperature. The air from the port must be taken to the silencer or, preferably, outside the potentially explosive area.
- The P1V-S motor must be connected to ground at all times, through its support, a metallic tube or separate conductor.
- The outlet of the P1V-S motor must not open within a potentially explosive area, but must be passed to the silencer or, preferably, removed and released outside the potentially explosive area.
- The P1V-S motor may only drive units that are ATEX certified.
- Ensure that the motor is not exposed to forces greater than those permitted in accordance with the catalogue.

Measuring the temperature on the outside of the P1V-S motor (only when used in potentially explosive areas)

During the commissioning process, it is essential to measure temperature increases at the indicated positions on the outside of the P1V-S motor.

These measurements can be taken using standard thermometers.

Checking the motor during operation

The motor must be kept clean on the outside, and a layer of dirt thicker than 5 mm must never be allowed to form. Strong solvents should not be used for cleaning, because they can cause the seal (material NBR/FPM) around the drive shaft to swell, potentially increasing the temperature.

P1V-S - Stainless Steel Air Motors

The temperature is measured on the metal surface next to the seal around the output shaft on all P1V-S012, P1V-S020, P1V-S028, P1V-S030, P1V-S057, P1V-S060, P1V-S086 and P1V-S090 motors.

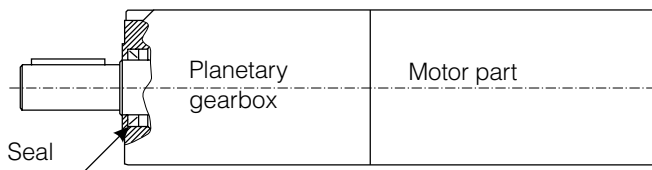

Motors P1V-S030A0023 and P1V-S030A0010

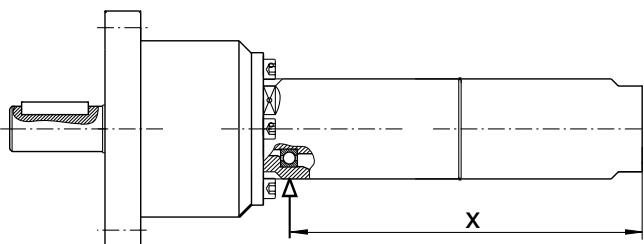

Motor	x [mm]
P1V-S030A0023	146
P1V-S030A0010	147,5

The maximum temperature is reached after approximately 1,5 hours of operation, and the difference in temperature between the motor and the ambient temperature must not exceed 40 °C.

If the temperature difference at the seal of a P1V-S 120 to 900 watts exceeds 40 °C, you should stop the motor immediately and contact Parker Hannifin.

The following applies to the P1V-S120 series:

The temperature is measured on the metal surface at a point 45 mm from the port end of the motor housing, on all P1V-S120.

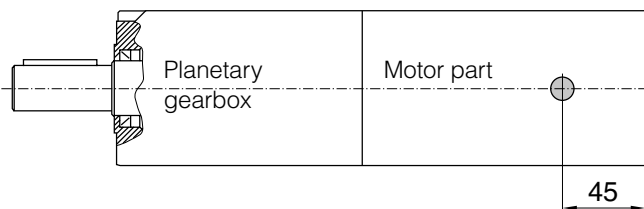

The maximum temperature is reached after approximately 1,5 hours of operation, and the difference in temperature between the motor and the ambient temperature must not exceed 55 °C.

If the temperature difference at this point on a P1V-S120 exceeds 55 °C, you should stop the motor immediately and contact Parker Hannifin.

Marking of products

For all P1V-S 120 to 900 watts



For the P1V-S120 1200 watts



- CE** Communauté Européenne = EU
CE marking shows that as a manufacturer, Parker Hannifin meets the guidelines specified by the EU
- Ex** means that this product is intended for use in a potentially explosive area
- II** stands for the equipment group (I = mines and II = other places liable to be endangered)
- 2GD** stands for equipment category
2G means the equipment can be used in zones 1 and 2 where there is a risk involving gas, vapour or mist of combustible liquids and **2D** in zones 21 and 22 where there is a risk involving dust .
2GD means the equipment can be used in zones 1, 2, 21 and 22.
- c** Safe design (prEN 13463-5)
- IIC** Explosion group, P1V-S air motors are tested to the highest standards in terms of test gases, and can be installed in the presence of all gases without restriction.
- T6** If equipment is in temperature class **T6**, the maximum surface temperature must not exceed 85 °C. (To guarantee this, the product has been tested to ensure that the maximum is 80 °C. This provides a safety margin of 5 °K.)
- T5** If equipment is in temperature class **T5**, the maximum surface temperature must not exceed 100 °C. (To guarantee this, the product has been tested to ensure that the maximum is 95 °C. This provides a safety margin of 5 °K.)
- (80 °C)** Maximum permitted surface temperature on the motor in atmospheres containing potentially explosive dust.
- X** Note special conditions

Test certificate number IBExU04ATEXB004 X from IBExU Institut für Sicherheitstechnik GmbH, D-09599 Freiberg, Germany

P1V-S Declaration of Conformity acc. ATEX 94/9/EC
P1V-S Declaration of Incorporation acc. EC
Machinery Directive 2006/42/EC



We Parker Hannifin Manufacturing
 Germany GmbH & Co. KG
 Pneumatic Division Europe
 Industriestrasse 8
 70794 Filderstadt Germany

Declare that the following Air Motors have been assessed in accordance with ATEX 94/9/EC (Products for use in potentially explosive atmospheres). Air Motors **P1V-S012, P1V-S020, P1V-S028, P1V-S030, P1V-S057, P1V-S060, P1V-S086** and **P1V-S090** range are compatible for the use in explosive atmosphere **Ex II 2 GD c T6 (T80°C) X**. Air Motors **P1V-S120** range are compatible for the use in explosive atmosphere **Ex II 2 GD c T5 (T95°C) X**. **All without brake option.**

P1V-S is designed for utilization in applications falling under the scope of the ATEX 94/9/EC. These products are designed and manufactured in compliance with following elements:

- **EN 1127-1:2007** Explosive atmospheres – Explosion prevention and protection – Part 1: Basic concepts and methodology
- **EN 13463-1:2009** Non electrical equipment for use in potentially explosive atmospheres – Part 1: Basic method and requirements
- **EN 13463-5** Non-electrical equipment intended for use in potentially explosive atmospheres – Part 5: Protection by constructional safety ‘c’
- **EN 983+A1:2008** Safety of machinery – Safety requirements for fluid power systems and their components - Pneumatics

As manufacturer of the partly completed machine we declare that:

- The specified Air motor corresponds to the listed essential requirements of the EC Machinery Directive 2006/42/EC
- The relevant technical documentation is compiled in accordance with part B of Annex VII
- The relevant technical documentation in accordance with part B of Annex VII will be transmitted in response to a reasonable request by the national authorities

Product: Air motors P1V-S

Directives	Date	Applied and fulfilled essential requirements
2006/42/EC	2006-06-06	1.1.2, 1.1.5, 1.3.4, 1.5.3, 1.7.3, 1.7.4

Standards	Date	Remark
DIN EN ISO 12100	2011-03	Partly fulfilled

This partly completed machinery must not be put into service until the final machinery into which it is to be incorporated has been declared in conformity with the provisions of the Directive 2006/42/EG, were appropriated.



Additional Information
 This coverage could only be referred to as long as operations needed for final assembling and starting up of these products comply with standards relating to the above mentioned directive. Each time this will be required for compliance purpose, the user will have to apply for a complete coverage of the final assembled system according to the above mentioned directive and relating standards

Filderstadt, Germany June 2014

Ing. Franck Roussillon
 European Product Manager
 Actuators Business Unit, Pneumatic Division Europe



Air Tools

To use in Robots and Automated Machines

Drilling type 80 to 600 Watts

Grinding type 90 to 300 Watts

Milling type 400 to 1000 Watts

Contents	Page
Introduction	67
Order model code	67
Technical data	68
Material specification	68
Permitted shaft loadings	69
Drilling motor with collet 80 watts	70
Dimensions	70
Drilling motor with collet 170 watts	71
Dimensions	71
Drilling motor for drill chuck 170 watts	72
Dimensions	72
Drilling motor with collet 250 watts	73
Dimensions	73
Drilling motor for drill chuck 250 watts	74
Dimensions	74
Drilling motor for drill chuck 400 watts	75
Dimensions	75
Drilling motor for drill chuck 600 watts	76
Dimensions	76
Mounting for drilling motors	77
Grinding motor with collet 90 watts	78
Grinding motor with collet 150 watts	79
Grinding motor with collet 250 watts	79
Grinding motor with collet 300 watts	79
Milling motor with collet 400 watts	80
Milling motor with collet 500 watts	81
Milling motor with collet 700 watts	81
Milling motor with collet 1000 watts	81
Dimensions	81
Lubrication and service life	82
Service kits	82

P1V-S - Drilling, Grinding & Milling Air Motors

Introduction

A large number of drilling motors, milling motors and grinding motors have been developed using the P1V-S as the base motor in order to make it easier to install air motors in machining applications. These motors are all equipped with standard vanes for intermittent lubrication-free operation, although it is recommended to use oil mist if you are planning to operate them for extended periods.

NOTE! These motors are not made of 100% stainless steel.

Drilling motors are available with power ratings of 80, 170, 250, 400 and 600 Watts, and several different speeds for the machining of a range of materials. They can be fitted with collet chucks, drill chucks and quick-release chucks. Many of them also have accessories allowing the exhaust air to be removed.

The milling motor, with a power rating of 400 Watts, runs at a relatively high speed, and is fitted with a collet chuck for a shaft diameter of 8 mm. It is equipped with strong bearings able to handle greater shear forces on the spindle.

The grinding motor, with a power rating of 200 Watts, is fitted with a collet chuck for a shaft diameter of 8 mm and runs at a relatively high speed. It is equipped with strong bearings able to handle greater shear forces on the spindle.

The design principle of the 90 Watt grinding motor is different from the others. The turbine principle means that high speeds are possible without the need for lubrication.

Feed movement in drilling, milling and grinding motors

A slow and even feed movement is necessary in machining applications. During drilling, the feed must not uncontrollably speed up once the drill breaks through the material. One good way of solving the problem is to use a pneumatic cylinder for the feed, which is able to provide force during drilling and a rapid approach before the actual drilling phase. Feed during the drilling phase is controlled using a hydraulic brake cylinder (HYDROCHECK) fitted in parallel with the pneumatic cylinder. This provides even, slow and safe feed movement, without the risk of the uncontrolled feed described above.

Order Code Key

(This model code can not be used for creating new part numbers. All possible combinations between motor size, function and free speed are in the next pages).

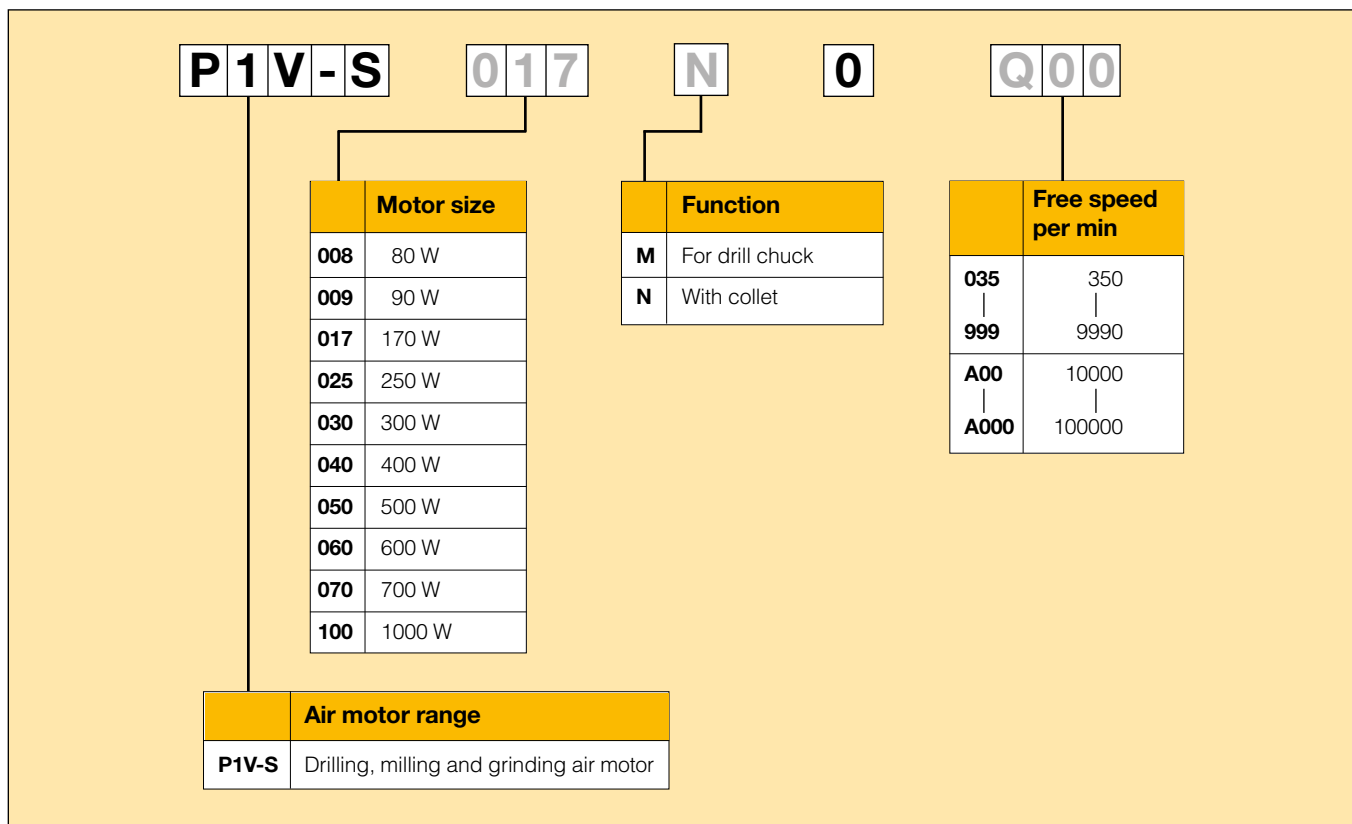

P1V-S - Drilling, Grinding & Milling Air Motors

Technical data (all air motors are non reversible, right rotation only)

Air motor size & type	P1V-S008	P1V-S017	P1V-S025	P1V-S040	P1V-S060	P1V-S009*	P1V-S015	P1V-S025	P1V-S030	P1V-S040	P1V-S050	P1V-S070	P1V-S100
Air motor type	Drilling					Grinding				Milling			
Nominal power (watts)	80	170	250	400	600	90	150	250	300	400	500	700	1000
Working pressure (bar)	3 to 7												
Working temperature (°C)	-20 to +110												
Ambient temperature (°C)	-20 to +110												
Air flow required (NI/min)	230	300	350	420	850	120	300	350	380	420	700	900	1100
Min pipe ID, inlet (mm)	4	6	6	10	12	4	6	6	6	10	10	10	10
Min pipe ID, outlet (mm)	4	6	6	10	12	4	6	6	6	10	10	10	10

Choice of treatment unit: recommended min air flow (l/min) at p1 7.5 bar and 0.8 bar pressure drop

	260	340	400	500	950	140	340	400	440	500	800	1020	1250
--	-----	-----	-----	-----	-----	-----	-----	-----	-----	-----	-----	------	------

Choice of valve: recommended min nominal air flow (l/min) at p1 6 bar and 1 bar pressure drop

	290	380	450	580	1050	160	380	450	510	580	900	1140	1400
Medium	40µm filtered, oil mist or dry unlubricated compressed air												
Oil free operation, indoor	ISO8573-1 purity class 3.4.1												
Oil free operation, outdoor	ISO8573-1 purity class 1.2.1												
Oil operation	1-2 drop per cube meter, ISO8573-1 purity class 3.-.5												
Recommended oil	Foodstuffs industry Klüber oil 4 UH1- 32 N												
Sound level free outlet (dB(A))	-	-	-	-	-	-	-	-	-	-	-	-	-
With outlet silencer (dB(A))	85	74	76	75	94	72	85	76	-	75	-	-	-
Exhaust air removed with pipes to another room	71	70	71	73	76	-	73	71	79	73	79	79	80

Note: sound levels are measured at free speed with the measuring instrument positioned 1 meter away from the air motor at an height of 1 meter.

* Un lubricated for grinding air motor P1V-S009.

Table and diagram data

All technical data are based on a working pressure of 6 bar and with oil. Oil-free performances are -10 to 15% lower.

Data tolerance accuracy +-10%

Material specification

Air motor size	P1V-S008	P1V-S017	P1V-S025	P1V-S040	P1V-S060	P1V-S009*	P1V-S015	P1V-S025	P1V-S030	P1V-S040	P1V-S050	P1V-S070	P1V-S100
Air motor type	Drilling					Grinding				Milling			
Housing	Stainless steel X12Cr13	High grade steel (not stainless)	Stainless steel X12Cr13			High grade steel (not stainless)				Stainless steel X12Cr13			
Shaft, collet	Hardened steel (not stainless)												
Shaft for drill chuck	Hardened and tempered steel (not stainless)												
Collet	Hardened and tempered steel (not stainless)												
All internal parts	High grade steel (not stainless)												
Accessories	Surface treated steel, plastic and aluminium												
Accessories	P1V Drilling air motors												
Flange bracket	Stainless steel												
Foot bracket	Stainless steel												
Screws for the mountings	Stainless steel DIN A2												

Permitted shaft loadings

Drilling, milling and grinding motors

Max. permitted load on output shaft for motors (based on 10 000 000 rpm at input shaft with 90 % probable service life for ball bearings).

Drilling motors with collet

Order code	Fax [N]	Frad [N]	a [mm]
P1V-S008N0***	200	75	25
P1V-S017N0***	380	50	25
P1V-S025N0***	750	220	25

Grinding motors with collet

Order code	Fax [N]	Frad [N]	a [mm]
P1V-S009N0A000	15	30	25
P1V-S015N0AQ0	15	30	25
P1V-S025N0Z00	25	50	25
P1V-S030N0***	20	40	25

Milling motors with collet

Order code	Fax [N]	Frad [N]	a [mm]
P1V-S040N0L00	750	150	25
P1V-S050N0L00	25	50	25
P1V-S070N0N00	40	90	25
P1V-S100N0F30	55	120	25

Frad = Radial loading (N)
 Fax = Axial loading (N)
 a = distance from shaft's end (mm)

Drilling motors for drill chuck

Order code	Fax [N]	Frad [N]	a [mm]
P1V-S017M0***	380	35	60
P1V-S025M0***	750	150	70
P1V-S040M0***	750	150	70
P1V-S060M0350	1100	150	80
P1V-S060M0270	1100	150	80
P1V-S060M0170	1100	150	80
P1V-S060M0063	1100	265	80
P1V-S060M0048	1100	265	80
P1V-S060M0030	1100	265	80
P1V-S060M0015	1100	150	80

Collet

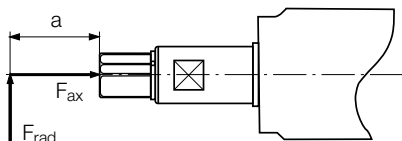

Collet

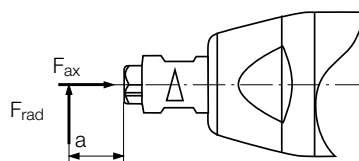

Drill chuck

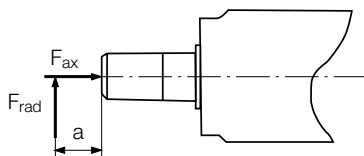

Collet

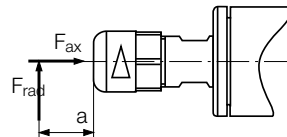

Collet

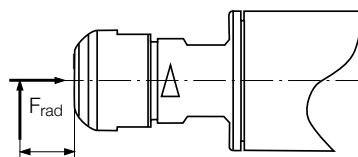

Load on output shaft for drilling, milling and grinding motors.

Drilling motor with collet P1V-S008N

Our smallest and most versatile drilling motor for small-scale drilling operations. The standard collet chuck is for 3 mm shaft diameter. For other diameters, select a different collet chuck as an accessory. The motor has a port for a 6 mm hose to remove the exhaust air to a silencer.

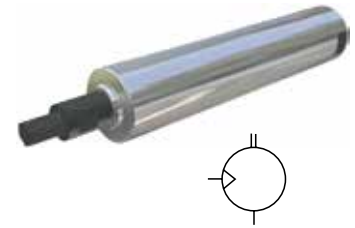

Note! All technical data are based on a working pressure of 6 bar and with oil. For oil-free performances are -10 to 15% lower. Data tolerance accuracy +-10%

Data for drilling motor with collet P1V-S008N

Max power kW	Free speed rpm	Version	Drilling in steel mm	Drilling in aluminium mm	Air consumption at max power l/s	Conn.	Min pipe ID mm	Weight Kg	Order code
0,080	22000	Collet 3 mm	-	3	3,8	M8 x 0,75*	4	0,20	P1V-S008N0N00
0,080	6000	Collet 3 mm	3	3	3,8	M8 x 0,75*	4	0,20	P1V-S008N0600
0,080	1900	Collet 3 mm	3	3	3,8	M8 x 0,75*	4	0,22	P1V-S008N0190
0,080	1300	Collet 3 mm	3	3	3,8	M8 x 0,75*	4	0,22	P1V-S008N0130

* 2 push in nipples for plastic pipe Ø6/4 supplied

Accessories for drilling motor with collet P1V-S008N

Name	Order code
Collet	
Collet Ø2 mm	P1V-6/314693
Collet Ø3 mm the motor	Included with
Collet Ø3/32"	P1V-6/314694
Collet Ø1/8"	P1V-6/314407

Dimensions (mm)

Drilling motor with collet P1V-S008N

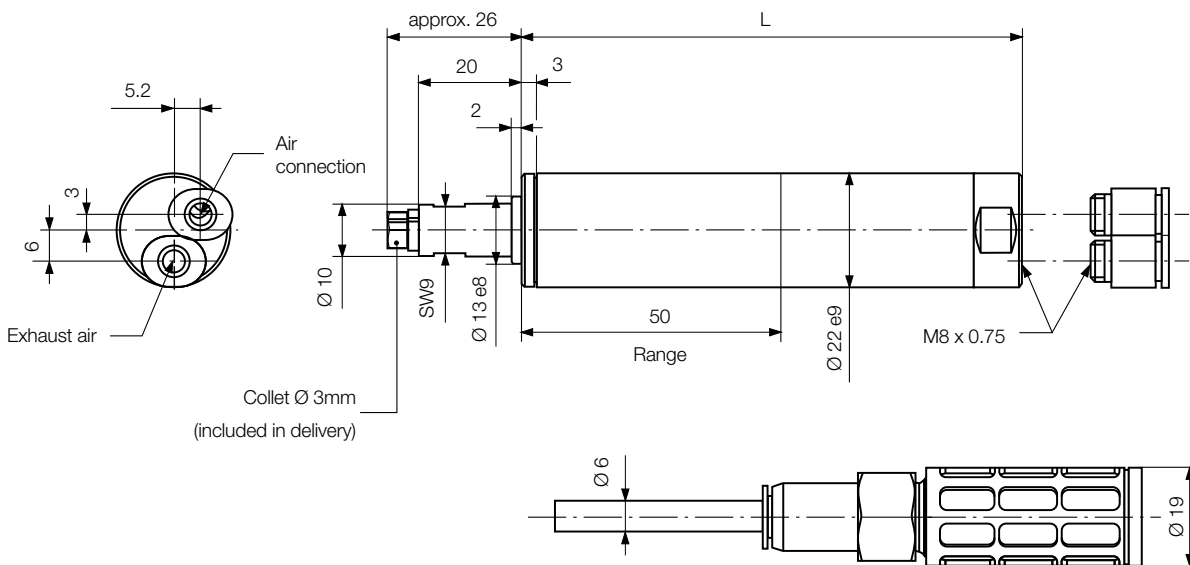

	A	B
P1V-S008N0N00, P1V-S008N0600	98	96
P1V-S008N0190, P1V-S008N0130	107	105

Drilling motor with collet P1V-S017N

A small drilling motor for small-scale, lighter drilling operations. The standard collet chuck is for 6 mm shaft diameter. For other diameters, select a different collet chuck as an accessory. The motor has a built-in silencer for exhaust air. If lower noise levels are required, or if you want the exhaust air to be collected, the relevant accessories are available.



Note! All technical data are based on a working pressure of 6 bar and with oil. For oil-free performances are -10 to 15% lower. Data tolerance accuracy +-10%

Data for drilling motor with collet P1V-S017N

Max power	Free speed	Version	Drilling in steel	Drilling in aluminium	Air consumption at max power	Conn.	Min pipe ID	Weight	Order code
kW	rpm		mm	mm	l/s		mm	Kg	
0,170	24000	Collet 6 mm	-	4	5,0	G1/4o	6	0,38	P1V-S017N0Q00
0,170	6000	Collet 6 mm	3	5	5,0	G1/4o	6	0,38	P1V-S017N0600
0,170	4000	Collet 6 mm	4	6	5,0	G1/4o	6	0,38	P1V-S017N0400
0,170	1500	Collet 6 mm	4	6	5,0	G1/4o	6	0,43	P1V-S017N0150
0,170	1000	Collet 6 mm	4	6	5,0	G1/4o	6	0,43	P1V-S017N0100
0,170	660	Collet 6 mm	4	6	5,0	G1/4o	6	0,43	P1V-S017N0066

Accessories for drilling motor with collet P1V-S017N

Name	Order code
Collet	
Collet Ø3 mm	P1V-6/312681
Collet Ø4 mm	P1V-6/312684
Collet Ø5 mm	P1V-6/312686
Collet Ø6 mm the motor	Included with
Collet Ø1/8"	P1V-6/312682
Collet Ø1/4"	P1V-6/312689
Other accessories	
Outlet hose	P1V-6/806112
Seal for outlet hose	P1V-6/823221
Outlet connection parallel	P1V-6/302923A

Dimensions (mm)

Drilling motor with collet P1V-S017N

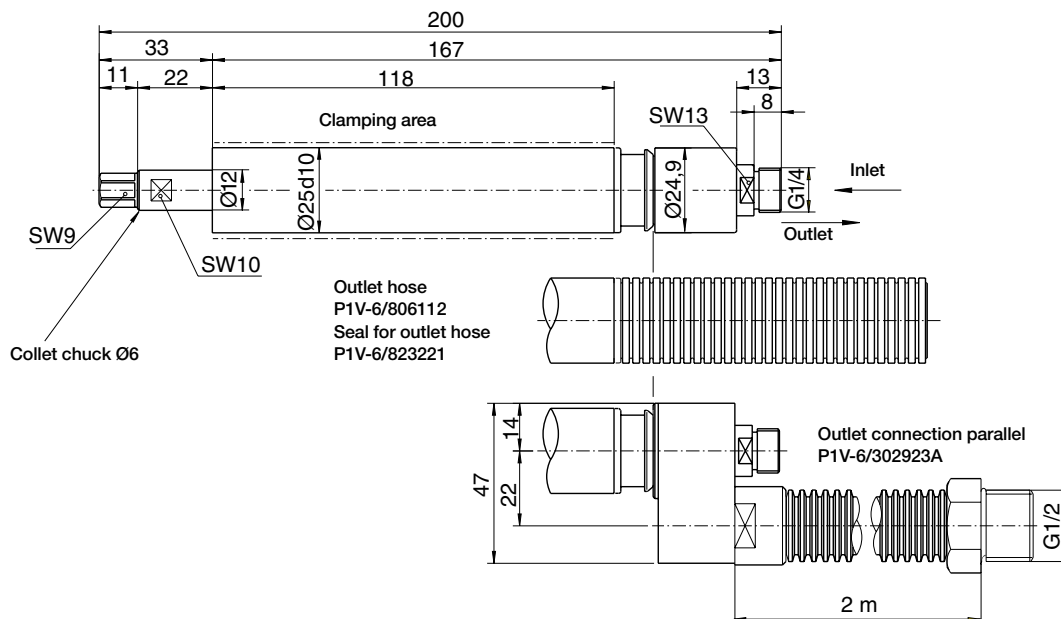

Drilling motor for drill chuck P1V-S017M

A small drilling motor for small-scale, lighter drilling operations. Select drill chucks as accessories. The motor has a built-in silencer for exhaust air. If lower noise levels are required, or if you want the exhaust air to be collected, the relevant accessories are available.



Note! All technical data are based on a working pressure of 6 bar and with oil. For oil-free performances are -10 to 15% lower. Data tolerance accuracy +-10%

Data for drilling motor for drill chuck P1V-S017M

Max power kW	Free speed rpm	Version	Drilling in steel mm	Drilling in aluminium mm	Air consumption at max power l/s	Conn.	Min pipe ID mm	Weight Kg	Order code
0,170	6000	For drill chuck B10	3	5	5,0	G1/4o	6	0,38	P1V-S017M0600
0,170	4000	For drill chuck B10	4	6	5,0	G1/4o	6	0,38	P1V-S017M0400
0,170	1500	For drill chuck B10	4	6	5,0	G1/4o	6	0,43	P1V-S017M0150
0,170	1000	For drill chuck B10	4	6	5,0	G1/4o	6	0,43	P1V-S017M0100
0,170	660	For drill chuck B10	4	6	5,0	G1/4o	6	0,43	P1V-S017M0066

Accessories for drilling motor for drill chuck P1V-S017M

Name	Order code
Standard drill chuck Diameters 0,5 – 6 mm/B10	P1V-6/804655
Other accessories	
Outlet hose	P1V-6/806112
Seal for outlet hose	P1V-6/823221
Outlet connection parallel	P1V-6/302923A

Dimensions (mm)

Drilling motor for drill chuck P1V-S017M

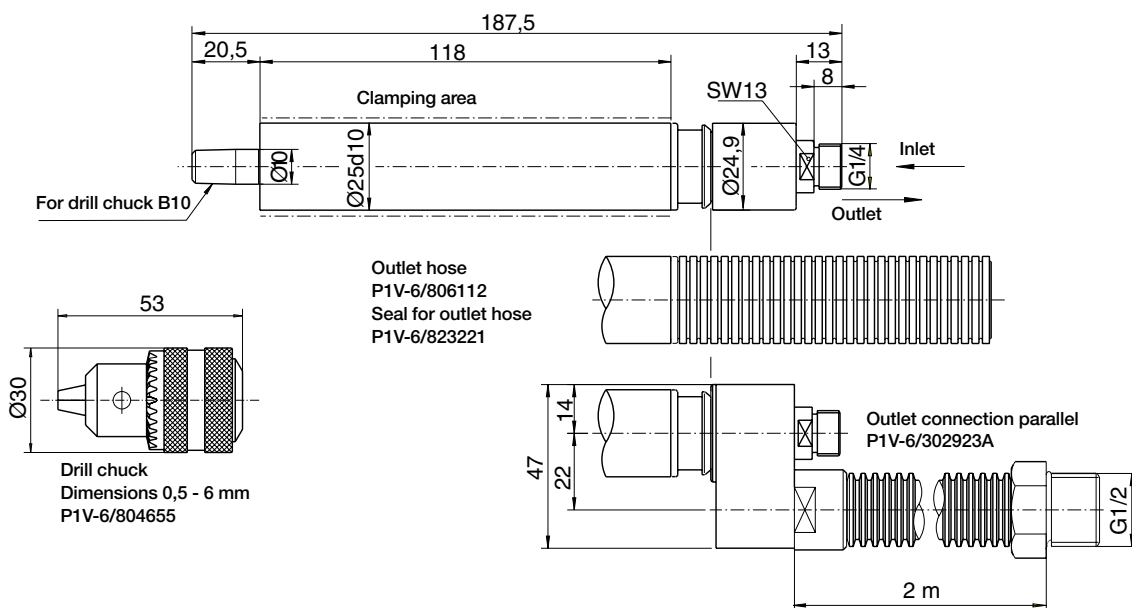

Drilling motor with collet P1V-S025N

A small drilling motor for moderately heavy drilling operations. The standard collet chuck is for 6 mm shaft diameter. For other diameters, select a different collet chuck as an accessory. The motor has a built-in silencer for exhaust air. If lower noise levels are required, or if you want the exhaust air to be collected, the relevant accessories are available.



Note! All technical data are based on a working pressure of 6 bar and with oil. For oil-free performances are -10 to 15% lower. Data tolerance accuracy +-10%

Data for drilling motor with collet P1V-S025N

Max power kW	Free speed rpm	Version	Drilling in steel mm	Drilling in aluminium mm	Air consumption at max power l/s	Conn.	Min pipe ID mm	Weight Kg	Order code
0,250	17000	Collet 6 mm	-	6	6,3	G1/4o	6	0,80	P1V-S025N0H00
0,250	4800	Collet 6 mm	4	6	6,3	G1/4o	6	0,80	P1V-S025N0480
0,250	2500	Collet 6 mm	6	6	6,3	G1/4o	6	0,80	P1V-S025N0250
0,250	1400	Collet 6 mm	6	6	6,3	G1/4o	6	0,90	P1V-S025N0140
0,250	700	Collet 6 mm	6	-	6,3	G1/4o	6	0,90	P1V-S025N0070
0,250	350	Collet 6 mm	6	-	6,3	G1/4o	6	0,90	P1V-S025N0035

Accessories for drilling motor with collet P1V-S025N

Name	Order code
Collet	
Collet Ø3 mm	P1V-6/312681
Collet Ø4 mm	P1V-6/312684
Collet Ø5 mm	P1V-6/312686
Collet Ø6 mm	Included with the motor
Collet Ø1/8"	P1V-6/312682
Collet Ø1/4"	P1V-6/312689
Other accessories	
Outlet connection straight	P1V-6/3131179A
Outlet hose Ø23 x 28 mm 0,75 m long	P1V-6/806110
Outlet connection parallel	P1V-6/388378A

Dimensions (mm)

Drilling motor with collet P1V-S025N

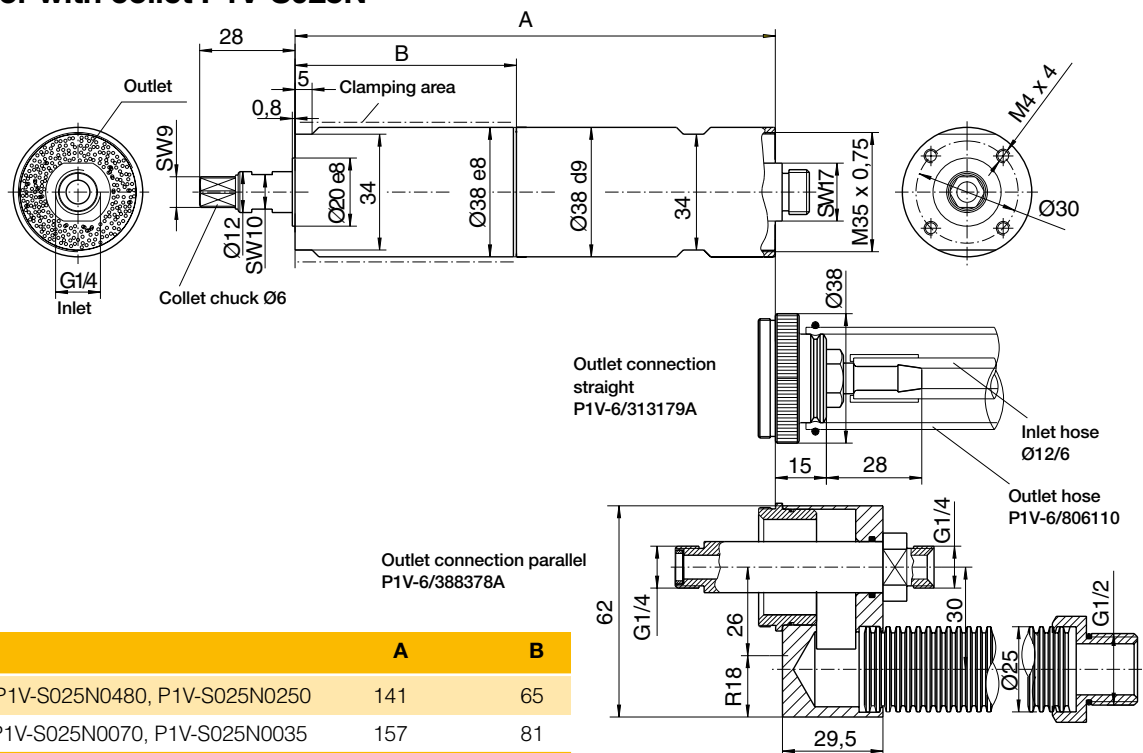

	A	B
P1V-S025N0H00, P1V-S025N0480, P1V-S025N0250	141	65
P1V-S025N0140, P1V-S025N0070, P1V-S025N0035	157	81

Drilling motor for drill chuck P1V-S025M

A small drilling motor for moderately heavy drilling operations. The standard collet chuck is for 6 mm shaft diameter. For other diameters, select a different collet chuck as an accessory. The motor has a built-in silencer for exhaust air. If lower noise levels are required, or if you want the exhaust air to be collected, the relevant accessories are available.



Note! All technical data are based on a working pressure of 6 bar and with oil. For oil-free performances are -10 to 15% lower. Data tolerance accuracy +-10%

Data for drilling motor for drill chuck P1V-S025M

Max power kW	Free speed rpm	Version	Drilling in steel mm	Drilling in aluminium mm	Air consumption at max power l/s	Conn.	Min pipe ID mm	Weight Kg	Order code
0,250	17000	For drill chuck B12	-	6	6,3	G1/4o	6	0,80	P1V-S025M0H00
0,250	4800	For drill chuck B12	4	6	6,3	G1/4o	6	0,80	P1V-S025M0480
0,250	2500	For drill chuck B12	6	8	6,3	G1/4o	6	0,80	P1V-S025M0250
0,250	1400	For drill chuck B12	8	10	6,3	G1/4o	6	0,80	P1V-S025M0140
0,250	700	For drill chuck B12	10	-	6,3	G1/4o	6	0,80	P1V-S025M0070
0,250	350	For drill chuck B12	10	-	6,3	G1/4o	6	0,80	P1V-S025M0035

Accessories for drilling motor for drill chuck P1V-S025M

Name	Order code
Standard drill chuck Diameters 0,8 - 10 mm/B12	P1V-6/804650
Quick release chuck Diameters 0,5 - 8 mm/B12	P1V-6/804661
Other accessories	
Outlet connection straight	P1V-6/313179A
Collet Ø1/4"	P1V-6/312689
Outlet hose Ø23 x 28 mm 0,75 m long	P1V-6/806110
Outlet connection parallel	P1V-6/388378A

Dimensions (mm)

Drilling motor for drill chuck P1V-S025M

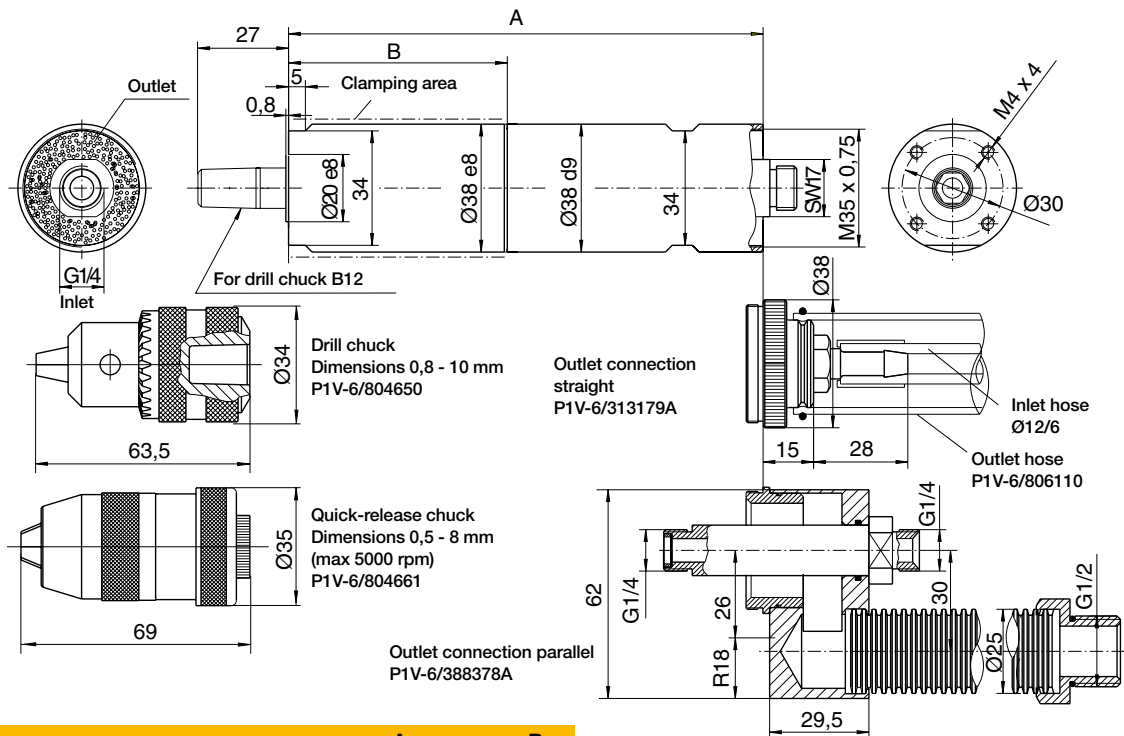

	A	B
P1V-S025M0H00, P1V-S025M0480, P1V-S025M0250	141	65
P1V-S025M0140, P1V-S025M0070, P1V-S025M0035	157	81

Drilling motor for drill chuck P1V-S040M

Our large drilling motor is used for small-scale heavy drilling operations requiring considerable feed force. Select drill chucks or quick-release chucks as accessories as necessary. The motor has a built-in silencer for exhaust air. If lower noise levels are required, or if you want the exhaust air to be collected, the relevant accessories are available.



Note! All technical data are based on a working pressure of 6 bar and with oil. For oil-free performances are -10 to 15% lower. Data tolerance accuracy +-10%

Data for drilling motor for drill chuck P1V-S040M

Max power kW	Free speed rpm	Version	Drilling in steel mm	Drilling in aluminium mm	Air consumption at max power l/s	Conn.	Min pipe ID mm	Weight Kg	Order code
0,400	17000	For drill chuck B12	-	6	8,0	G1/4o	6	0,82	P1V-S040M0H00
0,400	4800	For drill chuck B12	4	6	8,0	G1/4o	6	0,82	P1V-S040M0480
0,400	2500	For drill chuck B12	6	8	8,0	G1/4o	6	0,82	P1V-S040M0250
0,400	1400	For drill chuck B12	8	10	8,0	G1/4o	6	0,92	P1V-S040M0140

Accessories for drilling motor for drill chuck P1V-S040M

Name	Order code
Standard drill chuck Diameters 0,8 – 10 mm/B12	P1V-6/804650
Quick-release chuck Diameters 0,5 – 8 mm/B12 (Cannot be used for drilling motor P1V-S040M0H00)	P1V-6/804661
Other accessories Outlet connection straight	P1V-6/3131179A
Outlet hose Ø23 x 28 mm 0,75 m long	P1V-6/806110
Outlet connection parallel	P1V-6/388378A

Dimensions (mm)

Drilling motor for drill chuck P1V-S040M

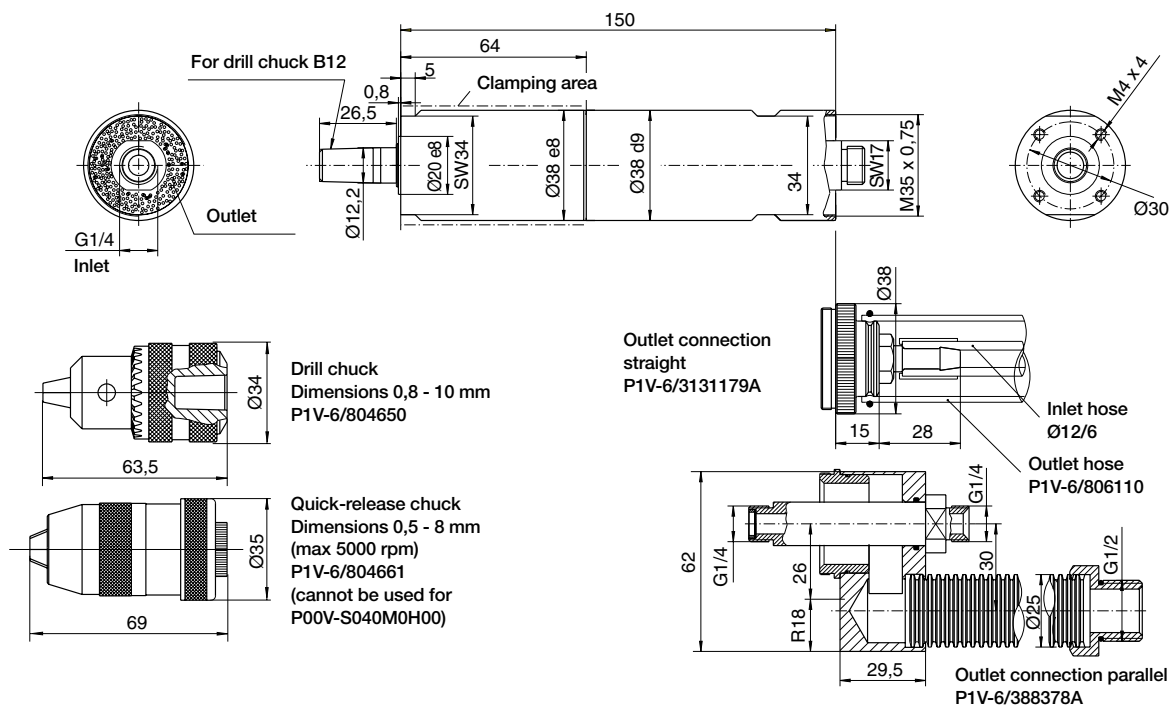

Drilling motor for drill chuck P1V-S060M

Our large drilling motor is used for small-scale heavy drilling operations requiring considerable feed force. Select drill chucks or quick-release chucks as accessories as necessary. The motor has a built-in silencer for exhaust air. If lower noise levels are required, or if you want the exhaust air to be collected, the relevant accessories are available.



Note! All technical data are based on a working pressure of 6 bar and with oil. For oil-free performances are -10 to 15% lower. Data tolerance accuracy +-10%

Data for drilling motor for drill chuck P1V-S060M

Max power	Free speed	Version	Drilling in steel	Drilling in aluminium	Air consumption at max power	Conn.	Min pipe ID	Weight	Order code
kW	rpm		mm	mm	l/s		mm	Kg	
0,600	3500	For drill chuck B16	3	3	14,2	G3/8	12	2,1	P1V-S060M0350
0,600	2700	For drill chuck B16	5	5	14,2	G3/8	12	2,1	P1V-S060M0270
0,600	1700	For drill chuck B16	8	8	14,2	G3/8	12	2,1	P1V-S060M0170
0,600	630	For drill chuck B16	13	13	14,2	G3/8	12	2,2	P1V-S060M0063
0,600	480	For drill chuck B16	13	13	14,2	G3/8	12	2,3	P1V-S060M0048
0,600	300	For drill chuck B16	13	13	14,2	G3/8	12	2,3	P1V-S060M0030
0,600	150	For drill chuck B16	13	13	14,2	G3/8	12	2,3	P1V-S060M0015

Accessories for drilling motor for drill chuck P1V-S060M

Name	Order code
Standard drill chuck Diameters 1 – 13 mm/B16	P1V-6/804652
Quick-release chuck Diameters 1 – 13 mm/B16	P1V-6/804663

Dimensions (mm)

Drilling motor for drill chuck P1V-S060M

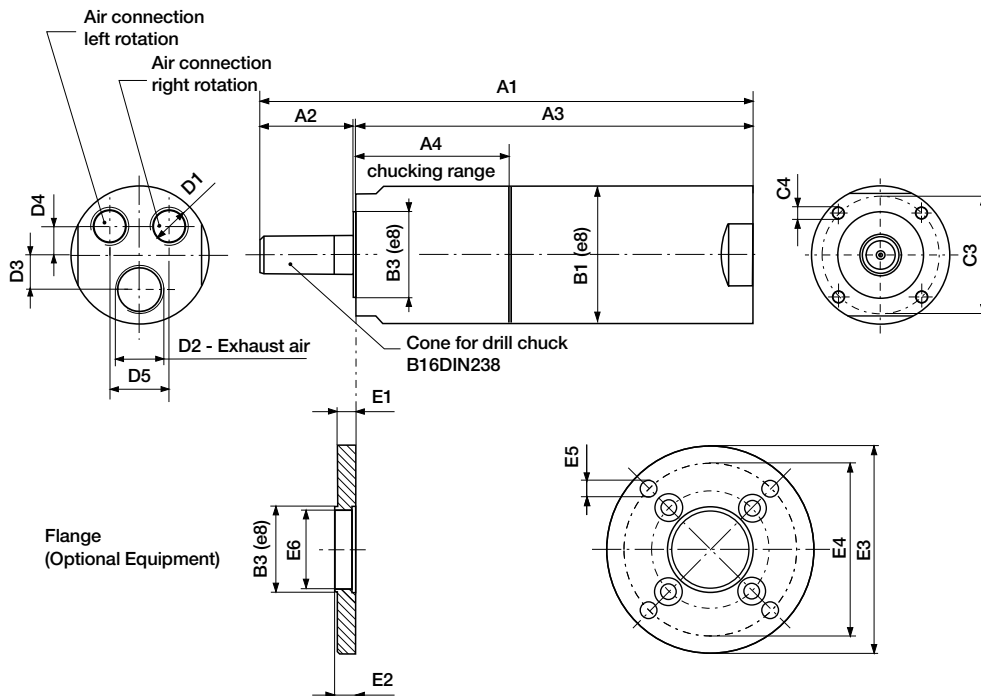

Mountings for drilling P1V-S air motors

Type	For drilling motor	Weight Kg	Order code
------	--------------------	--------------	------------

Flange

P1V-S008		0,04	P1V-S4008B
P1V-S025		0,09	P1V-S4020B
P1V-S040		0,12	P1V-S4030B
P1V-S060		0,25	P1V-S4060B

Foot bracket

P1V-S008		0,08	P1V-S4008F
P1V-S025		0,11	P1V-S4020F
P1V-S040		0,11	P1V-S4030F
P1V-S060		0,30	P1V-S4060F

All brackets supplied with fastening screws for the motor.

Grinding gear motor with collet (no vanes) P1V-S009N

The grinding motor is used for small-scale point grinding and small-scale milling where the high speed is an advantage. It has proved to be very useful for drilling small holes and milling thin slits in PCBs in the electronics industry. In this application, the high speed means that the holes and slits are free of burrs on the underside.



Note! All technical data are based on a working pressure of 6 bar and with oil. For oil-free performances are -10 to 15% lower. Data tolerance accuracy +-10%



Data for grinding gear motor with collet (no vanes) 90 W

Max power	Free speed	Version	Point grinding diam. max	Milling diam. max	Air consumption at max power	Conn.	Min pipe ID	Weight	Order code
kW	rpm		mm	mm	l/s		mm	Kg	
0,090	100000	Collet 3 mm	5	3	2,0	Pipe 6/4	4	0,3	P1V-S009N0A000

Dimensions (mm)

Grinding motor P1V-S009N0A000

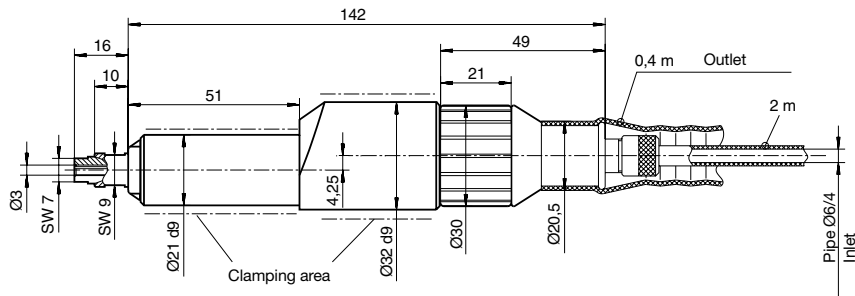

Grinding motors with collets 150, 250 & 300 W

This grinding motor is used when larger-scale point grinding is required. The motor can also be used for light milling operations. The motor has a built-in silencer for exhaust air.



Note! All technical data are based on a working pressure of 6 bar and with oil. For oil-free performances are -10 to 15% lower. Data tolerance accuracy +-10%

Data for grinding motors with collets 150, 250 & 300 W

Max power kW	Free speed rpm	Version	Point grinding diam. max mm	Milling diam. max mm	Air consumption at max power l/s	Conn.	Min pipe ID mm	Weight Kg	Order code
0,150	47000	Collet 6 mm	-	-	X	G 1/4o	6	0,36	P1V-S015N0AQ0
0,250	32000	Collet 6 mm	-	-	X	G 1/4o	6	0,80	P1V-S025N0Z00
0,300	30000	Collet 6 mm	-	-	X	G 1/4o	6	0,70	P1V-S030N0X00
0,300	45000	Collet 6 mm	-	-	X	-	6	0,70	P1V-S030N0AN0

Dimensions (mm)

Grinding motor P1V-S015N0AQ0

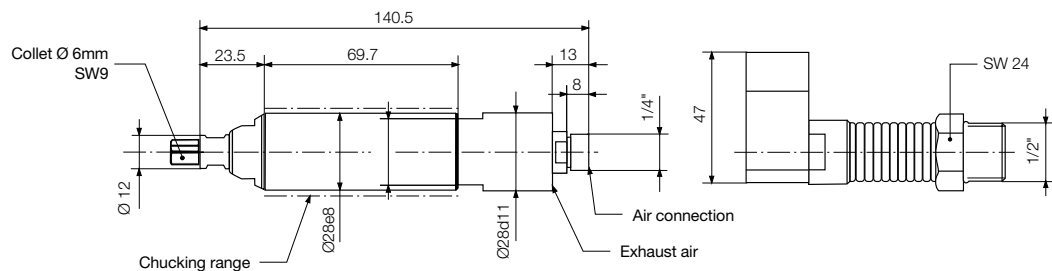

Grinding motor P1V-S025N0Z00

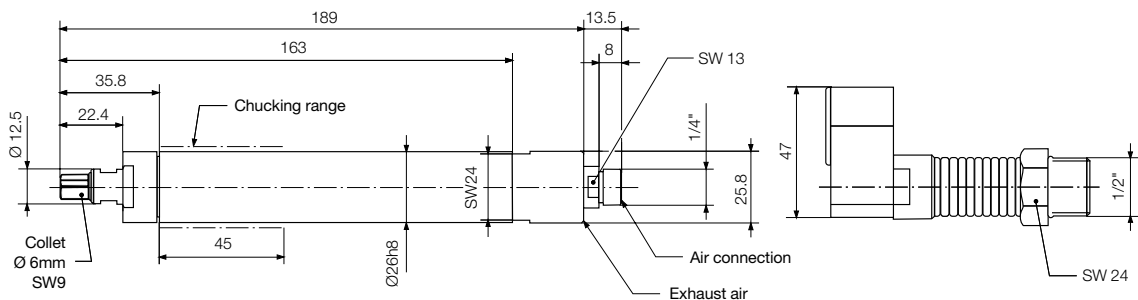

Grinding motor P1V-S030N0X00

Grinding motor P1V-S030N0AN0

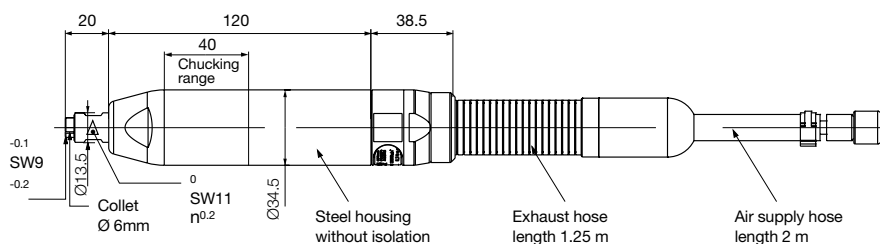

Milling motor with collet P1V-S040N

This motor was designed for milling plastic components, but it can also be used for milling other materials. The motor has a built-in silencer for exhaust air. If lower noise levels are required, or if you want the exhaust air to be collected, the relevant accessories are available.



Note! All technical data are based on a working pressure of 6 bar and with oil. For oil-free performances are -10 to 20% lower. Data tolerance accuracy +-10%

Data for milling motor with collet P1V-S040N

Max power	Free speed	Version	Milling of plastic mill dia. max mm	Milling of wood mill dia. max mm	Air consumption at max power l/s	Conn.	Min pipe ID	Weight	Order code
kW	rpm						mm	Kg	
0,400	20000	Collet 8mm	8	10	5,0	G1/4o	6	0,80	P1V-S040N0L00

Accessories for milling motor with collet P1V-S040N

Name	Order code
Collet	
Collet Ø3 mm	P1V-6/312690
Collet Ø4 mm	P1V-6/312692
Collet Ø5 mm	P1V-6/312693
Collet Ø6 mm	P1V-6/312694
Collet Ø8 mm	Included with the motor
Collet Ø1/8"	P1V-6/312691
Collet Ø1/4"	P1V-6/312695
Other accessories	
Outlet connection straight	P1V-6/313179A
Outlet hose Ø23 x 28 mm 0,75 m long	P1V-6/806110
Outlet connection parallel	P1V-6/388378A

Dimensions (mm)

Milling motor with collet P1V-S040N0L00

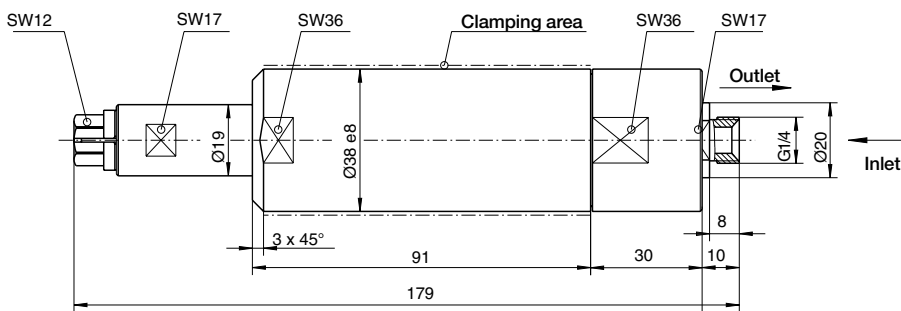

Outlet connection straight
P1V-6/313179A

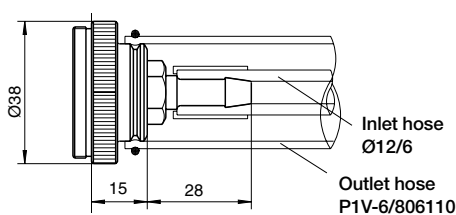

Outlet connection parallel
P1V-6/388378A

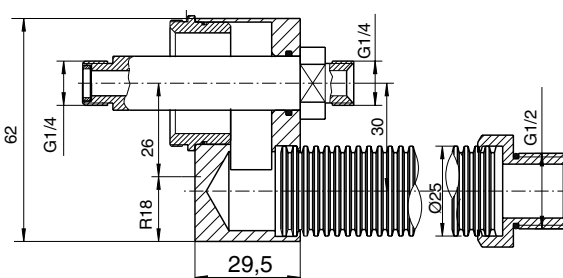

Milling motors with collets 500, 700 & 1000 W

This motor was designed for milling plastic components, but it can also be used for milling other materials. The motor has a built-in silencer for exhaust air. If lower noise levels are required, or if you want the exhaust air to be collected, the relevant accessories are available.

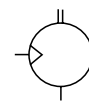

Note! All technical data are based on a working pressure of 6 bar and with oil. For oil-free performances are -10 to 15% lower. Data tolerance accuracy +-10%

Data for milling motors with collets 500, 700 & 1000 W

Max power	Free speed	Version	Air consumption at max power	Conn.	Min pipe ID	Weight	Order code
kW	rpm		l/s		mm	Kg	
0,500	20000	Collet 8 mm	15,0	-	10	1,20	P1V-S050N0L00
0,700	19000	Collet 8 mm	15,0	-	10	1,70	P1V-S070N0N00
1,000	15300	Collet 8 mm	16,7	-	12	1,70	P1V-S100N0F30

Dimensions (mm)

Milling motor with collet P1V-S050N0L00

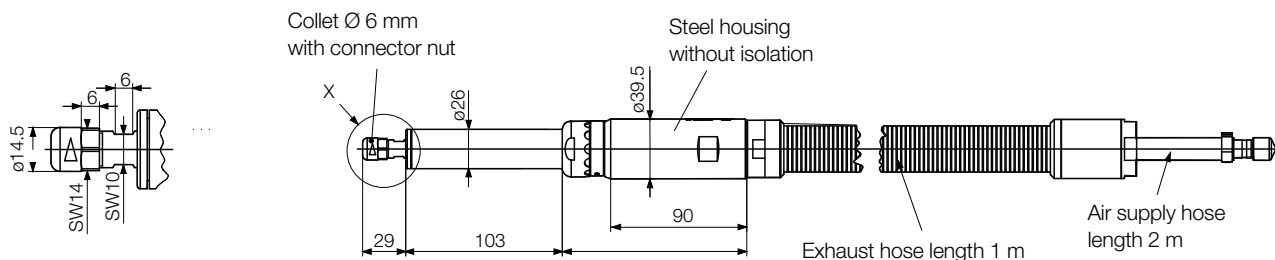

Milling motor with collet P1V-S070N0N00

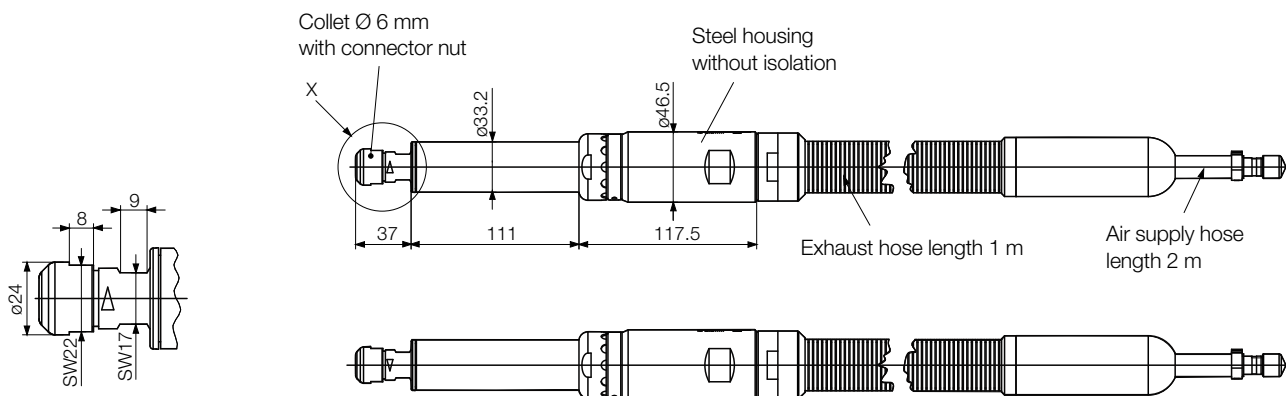

Milling motor with collet P1V-S100N0F30

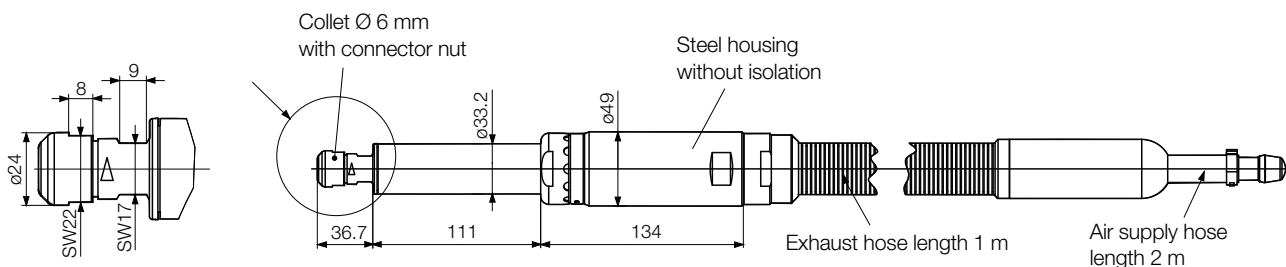

P1V-S - Drilling, Grinding & Milling Air Motors

Lubrication and service life



The first service is due after approximately 500 hours of operation. After the first service, the service interval is determined by the degree of vane wear*. The table below shows new dimensions and the minimum dimensions of worn vanes.

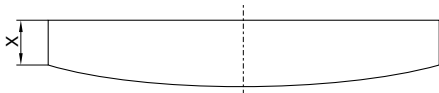

Drilling motors	New dimensions X (mm)	Minimum dimensions X (mm)
P1V-S008	4,3	4,0
P1V-S017	4,2	3,3
P1V-S025	6,5	5,8
P1V-S040	6,8	6,0

Milling motors	New dimensions X (mm)	Minimum dimensions X (mm)
P1V-S040	X	X
P1V-S050	X	X
P1V-S070	X	X
P1V-S100	X	X

Grinding motors	New dimensions X (mm)	Minimum dimensions X (mm)
P1V-S009	No vanes	No vanes
P1V-S015	X	X
P1V-S025	X	X
P1V-S030	X	X



* The specified hours of operation apply when the motor is running at the speed corresponding to maximum power (load speed). This is approximately half free speed. If the motor operates at higher speeds, the service interval is shorter. If the motor operates at lower speeds, the service interval is longer.

Service kits for drilling, milling and grinding motors

The following kits are available for the motors, consisting of vanes, (springs), silencers, O-rings, seals and 50 g of grease: (USDA-H1 approved)

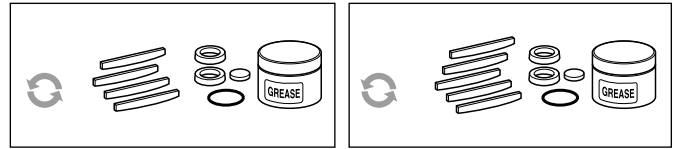

Service kits

For drilling motors	Order code
P1V-S008N	P1V-6/446085A
P1V-S017N/M	P1V-6/446086A
P1V-S025N/M	P1V-6/446087A
P1V-S040M	P1V-6/446088A
P1V-S060M0350	9121720604
P1V-S060M0270	9121720604
P1V-S060M0170	9121720604
P1V-S060M0063	9121720604
P1V-S060M0048	9121720605
P1V-S060M0030	9121720605
P1V-S060M0015	9121720605

For milling motors	Order code
P1V-S040N	P1V-6/446088A
P1V-S050N	P1V-6/4405021B
P1V-S070N	P1V-6/4405021C
P1V-S100N	P1V-6/4405021D

For grinding motors	Order code
P1V-S009N	Service free
P1V-S015N	P1V-6/4449221A
P1V-S025N	P1V-6/4449211A
P1V-S030N	P1V-6/4405021B

Parker Worldwide

AE – UAE, Dubai
Tel: +971 4 8127100
parker.me@parker.com

AR – Argentina, Buenos Aires
Tel: +54 3327 44 4129

AT – Austria, Wiener Neustadt
Tel: +43 (0)2622 23501-0
parker.austria@parker.com

AT – Eastern Europe, Wiener Neustadt
Tel: +43 (0)2622 23501 900
parker.easteurope@parker.com

AU – Australia, Castle Hill
Tel: +61 (0)2-9634 7777

AZ – Azerbaijan, Baku
Tel: +994 50 2233 458
parker.azerbaijan@parker.com

BE/LU – Belgium, Nivelles
Tel: +32 (0)67 280 900
parker.belgium@parker.com

BR – Brazil, Cachoeirinha RS
Tel: +55 51 3470 9144

BY – Belarus, Minsk
Tel: +375 17 209 9399
parker.belarus@parker.com

CA – Canada, Milton, Ontario
Tel: +1 905 693 3000

CH – Switzerland, Etoy
Tel: +41 (0)21 821 87 00
parker.switzerland@parker.com

CL – Chile, Santiago
Tel: +56 2 623 1216

CN – China, Shanghai
Tel: +86 21 2899 5000

CZ – Czech Republic, Klecany
Tel: +420 284 083 111
parker.czechrepublic@parker.com

DE – Germany, Kaarst
Tel: +49 (0)2131 4016 0
parker.germany@parker.com

DK – Denmark, Ballerup
Tel: +45 43 56 04 00
parker.denmark@parker.com

ES – Spain, Madrid
Tel: +34 902 330 001
parker.spain@parker.com

FI – Finland, Vantaa
Tel: +358 (0)20 753 2500
parker.finland@parker.com

FR – France, Contamine s/Arve
Tel: +33 (0)4 50 25 80 25
parker.france@parker.com

GR – Greece, Athens
Tel: +30 210 933 6450
parker.greece@parker.com

HK – Hong Kong
Tel: +852 2428 8008

HU – Hungary, Budapest
Tel: +36 1 220 4155
parker.hungary@parker.com

IE – Ireland, Dublin
Tel: +353 (0)1 466 6370
parker.ireland@parker.com

IN – India, Mumbai
Tel: +91 22 6513 7081-85

IT – Italy, Corsico (MI)
Tel: +39 02 45 19 21
parker.italy@parker.com

JP – Japan, Tokyo
Tel: +81 (0)3 6408 3901

KR – South Korea, Seoul
Tel: +82 2 559 0400

KZ – Kazakhstan, Almaty
Tel: +7 7272 505 800
parker.easteurope@parker.com

MX – Mexico, Apodaca
Tel: +52 81 8156 6000

MY – Malaysia, Shah Alam
Tel: +60 3 7849 0800

NL – The Netherlands, Oldenzaal
Tel: +31 (0)541 585 000
parker.nl@parker.com

NO – Norway, Asker
Tel: +47 66 75 34 00
parker.norway@parker.com

NZ – New Zealand, Mt Wellington
Tel: +64 9 574 1744

PL – Poland, Warsaw
Tel: +48 (0)22 573 24 00
parker.poland@parker.com

PT – Portugal, Leca da Palmeira
Tel: +351 22 999 7360
parker.portugal@parker.com

RO – Romania, Bucharest
Tel: +40 21 252 1382
parker.romania@parker.com

RU – Russia, Moscow
Tel: +7 495 645-2156
parker.russia@parker.com

SE – Sweden, Spånga
Tel: +46 (0)8 59 79 50 00
parker.sweden@parker.com

SG – Singapore
Tel: +65 6887 6300

SK – Slovakia, Banská Bystrica
Tel: +421 484 162 252
parker.slovakia@parker.com

SL – Slovenia, Novo Mesto
Tel: +386 7 337 6650
parker.slovenia@parker.com

TH – Thailand, Bangkok
Tel: +662 717 8140

TR – Turkey, Istanbul
Tel: +90 216 4997081
parker.turkey@parker.com

TW – Taiwan, Taipei
Tel: +886 2 2298 8987

UA – Ukraine, Kiev
Tel: +380 44 494 2731
parker.ukraine@parker.com

UK – United Kingdom, Warwick
Tel: +44 (0)1926 317 878
parker.uk@parker.com

US – USA, Cleveland
Tel: +1 216 896 3000

VE – Venezuela, Caracas
Tel: +58 212 238 5422

ZA – South Africa, Kempton Park
Tel: +27 (0)11 961 0700
parker.southafrica@parker.com

European Product Information Centre
Free phone: 00 800 27 27 5374
(from AT, BE, CH, CZ, DE, EE, ES, FI, FR, IE, IL, IS, IT, LU, MT, NL, NO, PT, SE, SK, UK)

Parker Hannifin Ltd.
Tachbrook Park Drive
Tachbrook Park, Warwick CV34 6TU
United Kingdom
Tel.: +44 (0) 1926 317 878
Fax: +44 (0) 1926 317 855
parker.uk@parker.com
www.parker.com

