

## Way Valves to VDMA 24563 and ISO5599

*Series S20*

### Contents

Version	Actuation	Standard / Size	Page		
			Characteristics	Dimension Table	Order Instructions Overview
5/2 and 5/3 Way Valves Series S20	Pneumatic Electrical	VDMA 24563 size 01	118, 119	120	124, 125
5/2 and 5/3 Way Valves Series S20	Pneumatic Electrical	ISO 5599 size 1	118, 119	121	124, 125
5/2 and 5/3 Way Valves Series S20	Pneumatic Electrical	ISO 5599 size 2	118, 119	122	124, 125
5/2 and 5/3 Way Valves Series S20	Pneumatic Electrical	ISO 5599 size 3	118, 119	123	124, 125

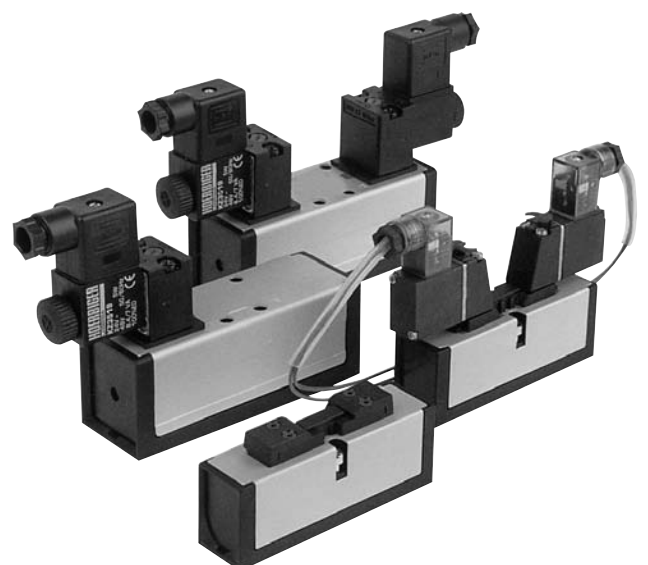

## Way Valves to VDMA 24563 and ISO5599

Series S20

### Characteristics

Characteristics	Symbol	Unit	Series S20 to VDMA 01	
Actuation			Pneumatic	Electrical
General Features				
Type			Ceramic-Spool valve	
Mounting			Via base plate to VDMA 24563	
Tube connection			Base Plate	
Port size			G1/8 or G1/4 (base plate)	
Weight				
– permanent signal		kg	0.130	0.170
– impulse version		kg	0.130	0.210
Installation				
Ambient temperature range <sup>(1)</sup>	T <sub>min. / max.</sub>	°C	-10 to +60	-10 to +60
Medium temperature range <sup>(1)</sup>	T <sub>min. / max.</sub>	°C	-10 to +55	-10 to +55
Medium			Filtered compressed air	
Lubrication			With or without oil mist lubrication (We recommend the use of mineral oil type VG 32 to ISO 3448)	
Pneumatic Characteristics				
Nominal pressure	p <sub>min. / max.</sub>	bar	6	6
Operating pressure range <sup>(2)</sup>				
– permanent signal version	p <sub>min. / max.</sub>	bar	-0.9 – 10	2 – 10
– impulse version	p <sub>min. / max.</sub>	bar	-0.9 – 10	2 – 10
– with external pilot air	p <sub>min. / max.</sub>	bar	–	-0.9 – 10
Maximum flow	Q <sub>max.</sub>	l/min	1050	1050
Actuation				
Pneumatic			Direct	–
Actuation pressure range				
– permanent signal version	p <sub>min. / max.</sub>	bar	2 – 10	2 – 10
– impulse version	p <sub>min. / max.</sub>	bar	2 – 10	2 – 10
Electrical				
Voltage type			AC 50/60Hz	Direct current
Nominal voltage				
– Standard version	Un	V	230 ±10%	24 ±10%
– Low wattage version	Un	V	–	–
Initial power consumption				
– Standard version		VA (W)	2 (Nominal Power)	2 (Nominal Power)
– Low wattage version		VA (W)	2 (Nominal Power)	2 (Nominal Power)
Continuous consumption				
– Standard version		VA (W)	–	–
– Low wattage version		VA (W)	–	–
Duty cycle	ED	%	100	
Electrical protection		IP	IP65 to DIN 40050 (applies only to solenoid with connector)	
Connection			Plug to DIN EN 175301-803 form C	

<sup>(1)</sup> Note:  
Please consult us for  
operating temperatures  
below 0° C

<sup>(2)</sup> 16 bar Version for  
valves to ISO 5599  
size 1, 2, 3 on request

<sup>(4)</sup> Low wattage version  
connector DIN EN  
175301-803 form A

Series S20 to ISO 5599						
Size 1		Size 2		Size 3		
Pneumatic	Electrical	Pneumatic	Electrical	Pneumatic	Electrical	
Ceramic-Spool valve						
via base plate to ISO5599						
Base plate						
G1/4 (Base plate)		G3/8 (Base plate)		G1/2 (Base plate)		
0.350	0.410	0.600	0.650	1.100	1.150	
0.350	0.450	0.600	0.700	1.100	1.200	
In any position	In any position	In any position	In any position	In any position	In any position	
-10 to +60	-10 to +60	-10 to +60	-10 to +60	-10 to +60	-10 to +60	
-10 to +60	-10 to +60	-10 to +60	-10 to +60	-10 to +60	-10 to +60	
Filtered compressed air						
With or without oil mist lubrication (We recommend the use of mineral oil type VG 32 to ISO 3448)						
6	6	6	6	6	6	
-0.9 – 12	2 – 12	-0.9 – 12	2 – 12	-0.9 – 12	2 – 12	
-0.9 – 12	2 – 12	-0.9 – 12	2 – 12	-0.9 – 12	2 – 12	
–	-1 – 12	–	-1 – 12	–	-1 – 12	
1680	1680	4320	4320	6540	6540	
Direct	–	Direct	–	Direct	–	
2 – 12	2 – 10	2 – 12	2 – 10	2 – 12	2 – 10	
2 – 12	2 – 10	2 – 12	2 – 10	2 – 12	2 – 10	
Pilot operated						
Alternating current 50/60Hz		Direct current				
230 ±10%		24 ±10%		other voltages		
230 ±10%		24 ±10%		on request		
11		4.8				
7.8		2.7				
8.5		4.8				
4.9		2.7				
100						
IP65 to DIN 40050 (applies only to solenoid with connector)						
Plug to DIN EN 175301-803 form B – industrial standard (4)						

# 5/2 and 5/3 Way Valves Series S20

to VDMA 24563  
Size 01

**Actuations:**  
– Pneumatic  
– Electrical pilot operated

**Versions:**  
– With external pilot air  
– With biased position

### Weight (mass) kg

Description	Type	Weight (mass)	* Type supplements for version with middle position
Pneumatic, by permanent signal	S20 561R..-01*	0.130	G = middle position closed
Pneumatic, by impulse	S20 561-01	0.130	E = middle position exhausted
Electrical, by permanent signal	S20 581R..-01*	0.170	B = middle position pressurized
Electrical, by permanent signal	S20 581S-R..-01*	0.170	
Electrical, by impulse	S20 581-01	0.210	
– with biased position	S20 582-01	0.210	
Electrical, by impulse	S20 581S-01	0.210	

### Pneumatically actuated – Type: S20 561...-01

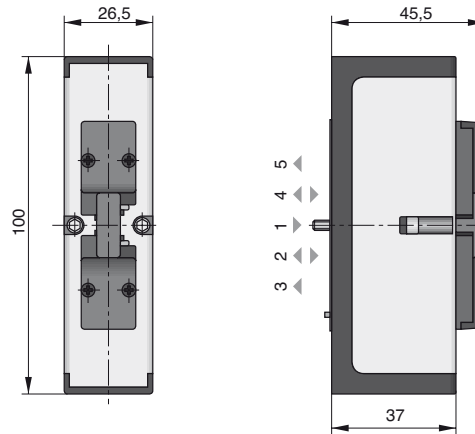

### Electrical pilot operated – Type: S20 581...-01-..., S20 582...-01-..., S20 581S...-01-...

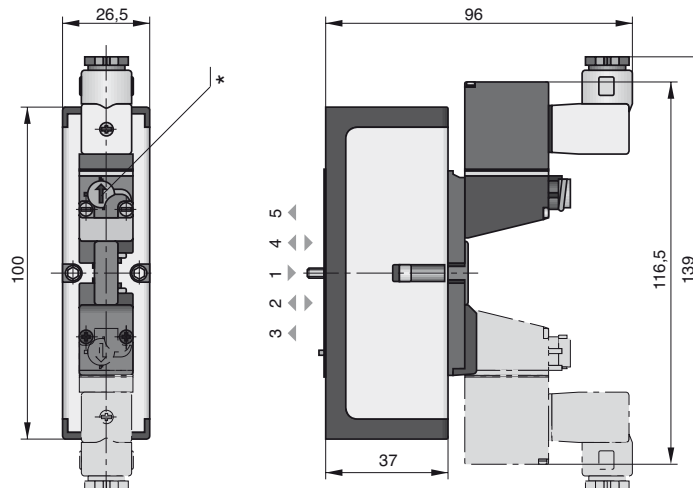

**The delivery includes:**  
1 Valve with mounting screws  
1 Gasket

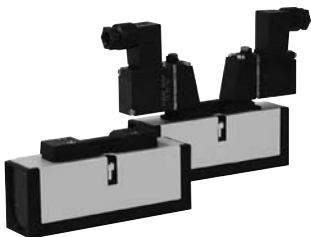

\* Manual override

Overview and order instructions see page 124, 125

Dimensions in mm

**Weight (mass) kg**

Description	Type	Weight (mass)	* Type supplements for version with middle position
Pneumatic, by permanent signal	S20 561R...-1*	0.350	
Pneumatic, by impulse	S20 561-1	0.350	
Electrical, by permanent signal	S20 581R...-1*	0.410	G = middle position closed
Electrical, by permanent signal	S20 581S-R...-1*	0.410	E = middle position exhausted
Electrical, by impulse	S20 581-1	0.450	B = middle position pressurized
- with biased position	S20 582-1	0.450	
Electrical, by impulse	S20 581S-1	0.450	

## 5/2 and 5/3 Way Valves Series S20

to ISO 5599 size 1

**Actuations:**  
 - Pneumatic  
 - Electrical pilot operated

**Versions:**  
 - With external pilot air  
 - With biased position  
 - Low wattage version

**Pneumatically actuated – Type: S20 561...-1**

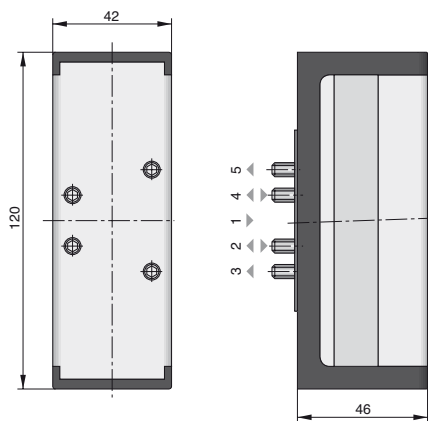

**Electrical pilot operated  
 Type: S20 581...-1..., S20 582-1..., S20 581S...-1...**

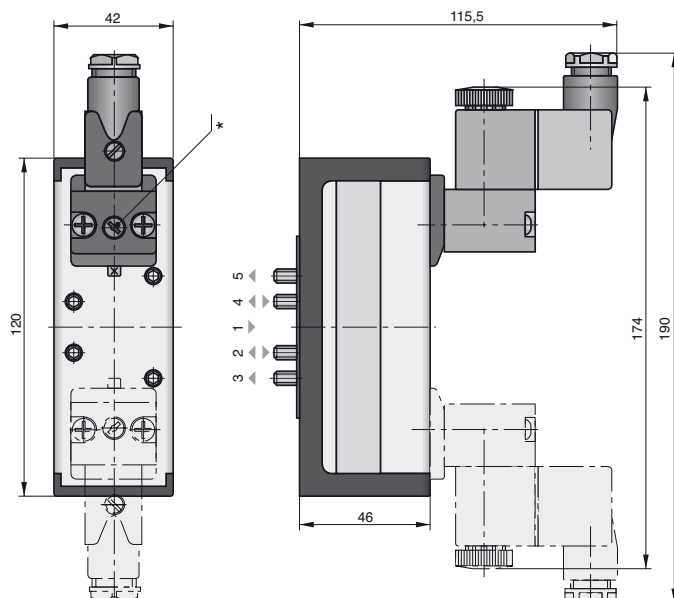

**Magnet for low wattage version**

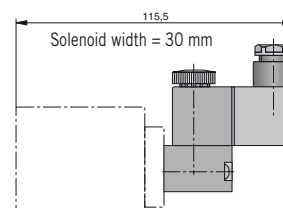

\* Manual override

Overview and order instructions see page 124, 125

Dimensions in mm

**The delivery includes:**  
 1 Valve with mounting screws  
 1 Gasket

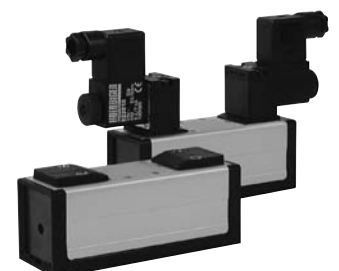

# 5/2 and 5/3 Way Valves Series S20

to ISO 5599  
size 2

**Actuations:**  
– Pneumatic  
– Electrical pilot operated

**Versions:**  
– With external pilot air  
– With biased position  
– Low wattage version

**The delivery includes:**  
1 Valve with mounting screws  
1 Gasket

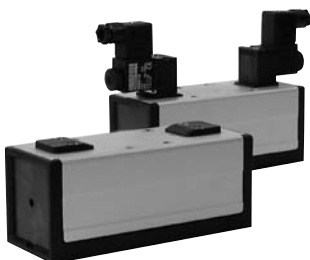

### Weight (mass) kg

Description	Type	Weight (mass)	* Type supplements for version with middle position
Pneumatic, by permanent signal	S20 561R..-2*	0.600	G = middle position closed E = middle position exhausted B = middle position pressurized
Pneumatic, by impulse	S20 561-2	0.600	
Electrical, by permanent signal	S20 581R..-2*	0.650	
Electrical, by permanent signal	S20 581S-R..-2*	0.650	
Electrical, by impulse	S20 581-2	0.700	
– with biased position	S20 582-2	0.700	
Electrical, by impulse	S20 581S-2	0.700	

### Pneumatically actuated – Type: S20 561...-2

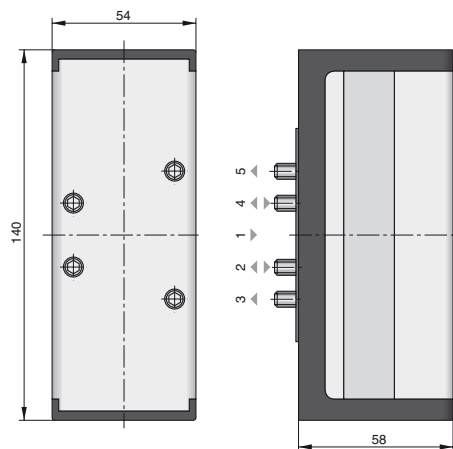

### Electrical pilot operated Type: S20 581...-2-..., S20 582-2-..., S20 581S...-2-..

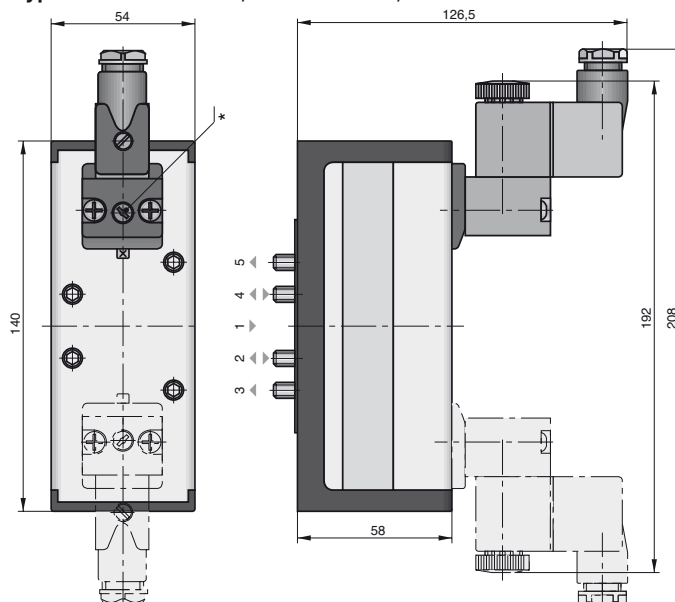

\* Manual override

### Magnet for low wattage version

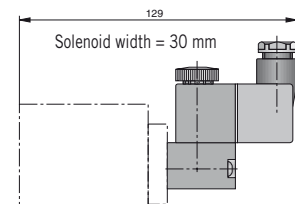

Overview and order instructions see page 124, 125

Dimensions in mm

## 5/2 and 5/3 Way Valves Series S20

to ISO 5599  
size 3

**Actuations:**  
– Pneumatic  
– Electrical pilot operated

**Versions:**  
– With external pilot air  
– With biased position  
– Low wattage version

### Weight (mass) kg

Description	Type	Weight (mass)	* Type supplements for version with middle position
Pneumatic, by permanent signal	S20 561R...-3*	1.100	G = middle position closed
Pneumatic, by impulse	S20 561-3	1.100	E = middle position exhausted
Electrical, by permanent signal	S20 581R...-3*	1.150	B = middle position pressurized
Electrical, by permanent signal	S20 581S-R...-3*	1.150	
Electrical, by impulse	S20 581-3	1.200	
– with biased position	S20 582-3	1.200	
Electrical, by impulse	S20 581S-3	1.200	

**Pneumatically actuated – Type: S20 561...-3**

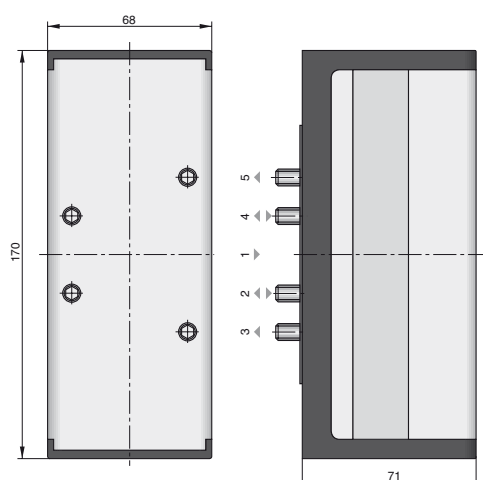

**Electrical pilot operated – Type: S20 581...-3..**

**Magnet for low wattage version**

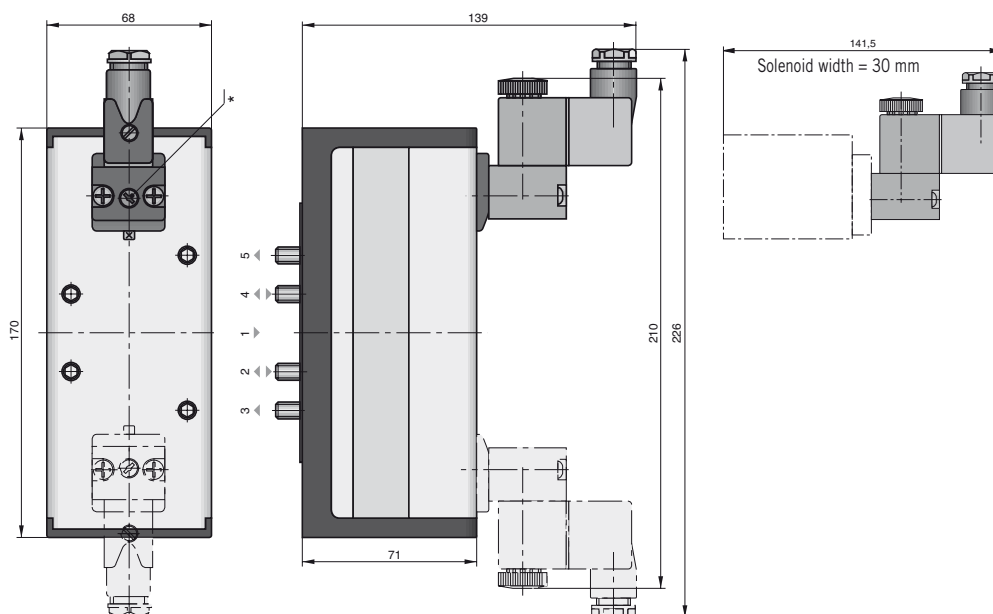

\* Manual override



Overview and order instructions see page 124, 125

Dimensions in mm

**The delivery includes:**  
1 valve with mounting screws  
1 Gasket

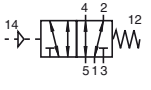
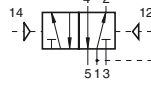
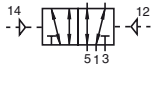
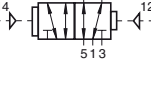

### Order Instructions – 5/2 Way Valves

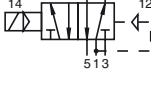
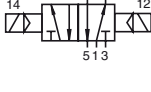
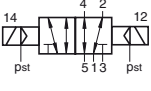
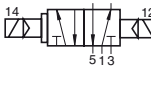
Actuation	Symbol	Standard / Size	Order Instructions		Page
			Type	Order No.	
Pneumatic by permanent signal, spring return		VDMA 24563 Gr.01	S20 561RF-01	PA 12891	120
		ISO 5599 Größe 1	S20 561RF-1	PA 12869	121
		ISO 5599 size 2	S20 561RF-2	PA 16425	122
		ISO 5599 size 3	S20 561RF-3	PA 16426	123
Pneumatic by permanent signal, air spring return		VDMA 24563 Gr.01	S20 561R-01	PA 12892	120
		ISO 5599 size 1	S20 561R-1	PA 12870	121
		ISO 5599 size 2	S20 561R-2	PA 16428	122
		ISO 5599 size 3	S20 561R-3	PA 16429	123
Pneumatic by impulse		VDMA 24563 Gr.01	S20 561-01	PA 12893	120
		ISO 5599 size 1	S20 561-1	PA 12868	121
		ISO 5599 size 2	S20 561-2	PA 16422	122
		ISO 5599 size 3	S20 561-3	PA 16423	123
Pneumatic by impulse with biased position		VDMA 24563 Gr.01	S20 562-01	PA 12908	120
		ISO 5599 size 1	S20 562-1	PA 12905	121
		ISO 5599 size 2	S20 562-2	PA 12906	122
		ISO 5599 size 3	S20 562-3	PA 12907	123
Electrical by permanent signal, spring return  with external pilot air		VDMA 24563 Gr.01	S20 581RF-01-..	PA 12886-..33	120
		ISO 5599 size 1	S20 581RF-1-..	PA 12875-..33	121
		ISO 5599 size 2	S20 581RF-2-..	PA 16441-..33	122
		ISO 5599 size 3	S20 581RF-3-..	PA 16442-..33	123
		VDMA 24563 Gr.01	S20 581S-RF-01-..	PA 12896-..33	120
		ISO 5599 size 1	S20 581S-RF-1-..	PA 12882-..33	121
		ISO 5599 size 2	S20 581S-RF-2-..	PA 16456-..33	122
		ISO 5599 size 3	S20 581S-RF-3-..	PA 16462-..33	123
Electrical by permanent signal, air spring return		VDMA 24563 Gr.01	S20 581R-01-..	PA 12887-..33	120
		ISO 5599 size 1	S20 581R-1-..	PA 12876-..33	121
		ISO 5599 size 2	S20 581R-2-..	PA 16444-..33	122
		ISO 5599 size 3	S20 581R-3-..	PA 16445-..33	123
Electrical by impulse  with external pilot air		VDMA 24563 Gr.01	S20 581-01-..	PA 12888-..33	120
		ISO 5599 size 1	S20 581-1-..	PA 12874-..33	121
		ISO 5599 size 2	S20 581-2-..	PA 16438-..33	122
		ISO 5599 size 3	S20 581-3-..	PA 16439-..33	123
		VDMA 24563 Gr.01	S20 581S-01-..	PA 12898-..33	120
		ISO 5599 size 1	S20 581S-1-..	PA 12880-..33	121
		ISO 5599 size 2	S20 581S-2-..	PA 16454-..33	122
		ISO 5599 size 3	S20 581S-3-..	PA 16460-..33	123
Electrical by impulse with biased position		VDMA 24563 Gr.01	S20 582-01-..	PA 12904-..33	120
		ISO 5599 size 1	S20 582-1-..	PA 12901-..33	121
		ISO 5599 size 2	S20 582-2-..	PA 12902-..33	122
		ISO 5599 size 3	S20 582-3-..	PA 12903-..33	123

Type and additional order instructions see page 125

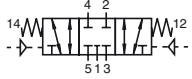
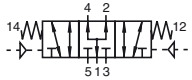
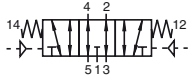
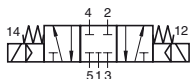
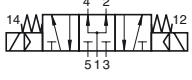
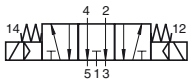
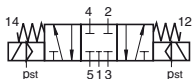
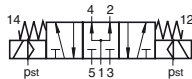
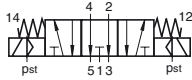

### Order Instructions – 5/3 Way Valves

Actuation	Symbol	Standard / Size	Order Instructions		Page	
			Type	Order No.		
Pneumatic by permanent signal, spring return to middle position		VDMA 24563 Gr. 01	S20 561RFG-01	PA 12894	120	
		ISO 5599 size 1	S20 561RFG-1	PA 12871	121	
		ISO 5599 size 2	S20 561RFG-2	PA 16431	122	
		ISO 5599 size 3	S20 561RFG-3	PA 16432	123	
		ISO 5599 size 1	S20 561RFB-1	PA 12873	121	
		ISO 5599 size 2	S20 561RFB-2	PA 16437	122	
		VDMA 24563 Gr. 01	S20 561RFE-01	PA 12895	120	
		ISO 5599 size 1	S20 561RFE-1	PA 12872	121	
		ISO 5599 size 2	S20 561RFE-2	PA 16434	122	
		ISO 5599 size 3	S20 561RFE-3	PA 16435	123	
		VDMA 24563 Gr. 01	S20 581RFG-01	PA 12889-..33	120	
		ISO 5599 size 1	S20 581RFG-1-..	PA 12877-..33	121	
Electrical by permanent signal, spring return to middle position		ISO 5599 size 2	S20 581RFG-2-..	PA 16447-..33	122	
		ISO 5599 size 3	S20 581RFG-3-..	PA 16448-..33	123	
			ISO 5599 size 1	S20 581RFB-1-..	PA 12879-..33	121
			ISO 5599 size 2	S20 581RFB-2-..	PA 16453-..33	122
			VDMA 24563 Gr. 01	S20 581RFE-01	PA 12890-..33	120
			ISO 5599 size 1	S20 581RFE-1-..	PA 12878-..33	121
		ISO 5599 size 2	S20 581RFE-2-..	PA 16450-..33	122	
		ISO 5599 size 3	S20 581RFE-3-..	PA 16451-..33	123	
	with external pilot air		VDMA 24563 Gr. 01	S20 581S-RFG-01-..	PA 12900-..33	120
			ISO 5599 size 1	S20 581S-RFG-1-..	PA 12883-..33	121
			ISO 5599 size 2	S20 581S-RFG-2-..	PA 16457-..33	122
			ISO 5599 size 3	S20 581S-RFG-3-..	PA 16463-..33	123
		ISO 5599 size 1	S20 581S-RFB-1-..	PA 12885-..33	121	
		ISO 5599 size 2	S20 581S-RFB-2-..	PA 16459-..33	122	
			VDMA 24563 Gr. 01	S20 581S-RFE-01-..	PA 12899-..33	120
			ISO 5599 size 1	S20 581S-RFE-1-..	PA 12884-..33	121
ISO 5599 size 2			S20 581S-RFE-2-..	PA 16458-..33	122	
ISO 5599 size 3			S20 581S-RFE-3-..	PA 16464-..33	123	

Solenoid version	Nominal voltage	Applicable for	Key code
Standard version	230V 50/60Hz	110 V =	61
	24V =	60V 50/60Hz	02
Low wattage version	24V =		13
	230V 50/60Hz		69
Other voltages on request			



**Contents**

Version	Standard / Size	Page	
		Dimensions	Order Instructions Overview
Single Base Plates G1/8, G1/4	VDMA 24563 size 01	128	128
Modules for Base Plate Combinations G1/8, G1/4	VDMA 24563 size 01	129	129
Single Base Plates	ISO 5599 size 1, 2, 3	130, 131	130, 131
Base Plate combinations	ISO 5599 size 1, 2, 3	132, 133	132, 133

## Single Base Plates

– to VDMA 24563,  
Size 01

– to ISO 5599  
Size 1, 2, 3

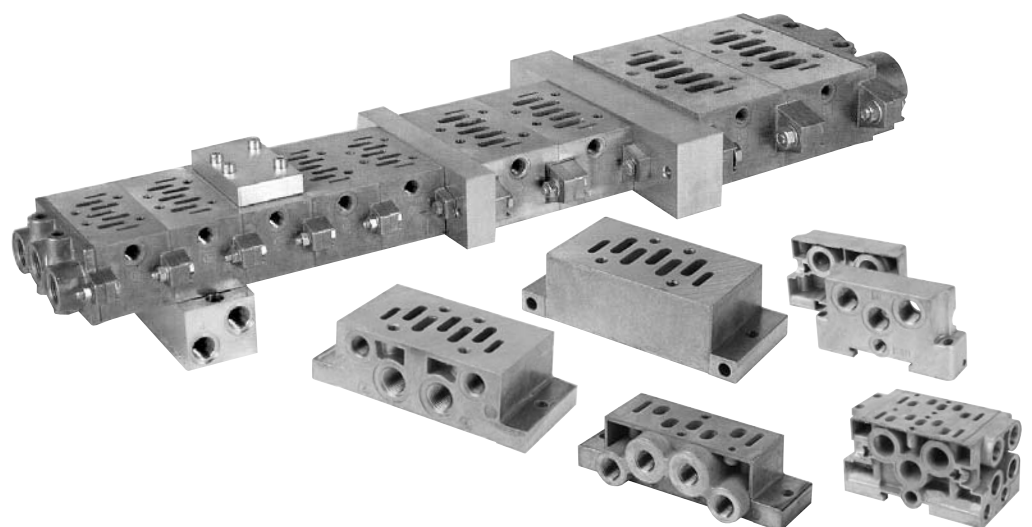

# Single Base Plates

to VDMA 24563  
Size 01, Form A

Port size:  
G1/8  
G1/4

Single Base Plates Form A – Connection size G1/8 – Type: S20-01-1/8-A

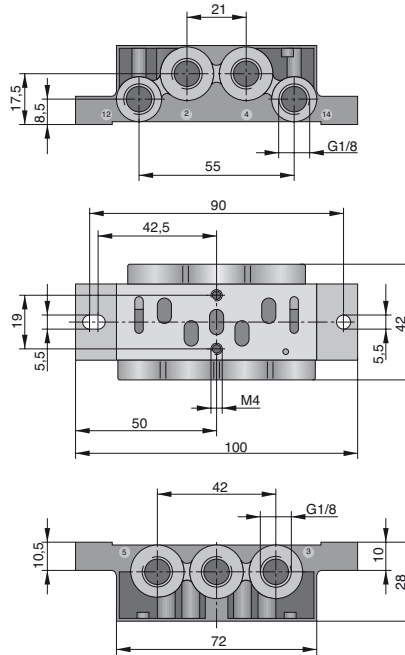

Single Base Plates Form A – Connection size G1/4 – Type: S20-01-1/4-A

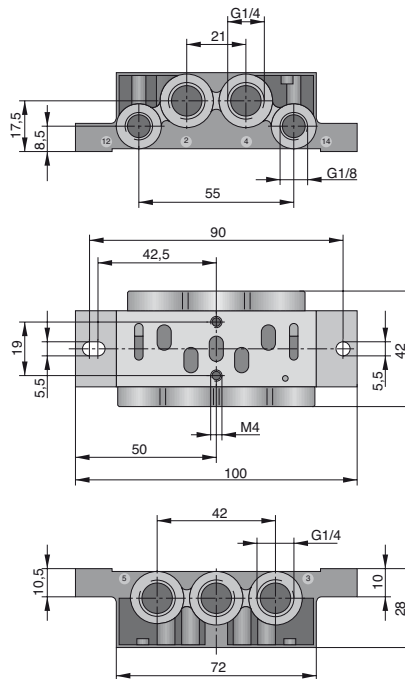

### Order Instructions

Description	Connection	Weight (kg)	Order Instructions	
			Type	Order No.
Single Base Plate	G1/8	0.070	S20-01-1/8-A	KL8004
	G1/4	0.120	S20-01-1/4-A	KL8005

Dimensions in mm

### End Plate Set Form D for Intermediate Plate

Description	Size	Weight (kg)	Order Instructions		Figure
			Type	Order No.	
End Plate set Form D	VDMA 01	0.220	S20-01-D	KL8008	

**The delivery includes:** End Plate set, completely with screws

### Intermediate Plate Form C

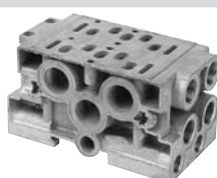
Description	Port size (Connection)	Weight (kg)	Order Instructions		Figure
			Type	Order No.	
Intermediate Plate form C	VDMA 01 (G1/8)	0.080	S20-01-C	KL8006	
Intermediate Plate form C	VDMA 01 (G1/4)	0.100	S20-01-C	KL8007	

**The delivery includes:** Intermediate Plate, completely with O-Rings and screws

### Dummy plate

Description	Size	Weight (kg)	Order Instructions		Figure
			Type	Order No.	
Dummy Plate	VDMA 01	0.050	S20-01-BP	KL8009	

**The delivery includes:** Dummy Plate with gasket and screws

## Modules for Base Plate Combinations

to VDMA 24563 size 01

**Modules:**  
 – End Plate set, Form D, for Intermediate Plate Form C  
 – Angle base plate, Form E, for Intermediate Plate Form C  
 – Accessories

**Port size:**  
 G1/8  
 G1/4

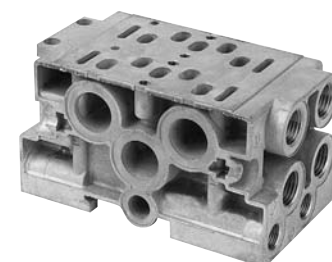

Dimensions in mm

# Base Plates

to ISO 5599  
Size 1, 2, 3

Versions:  
– Single Base Plates  
to VDMA 24345 Form A

## Single Base Plates Form A – Type: S9-.-A

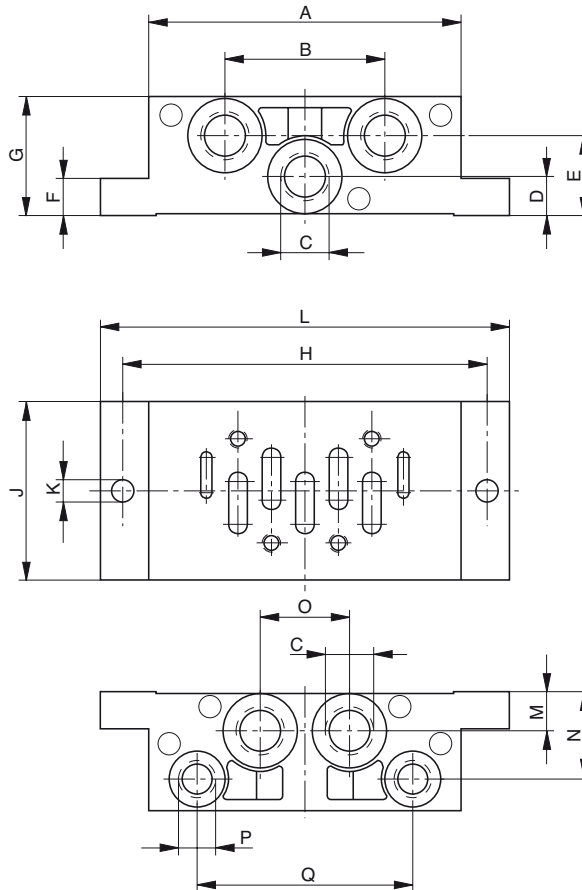

**Dimension Table Single Base Plates Form A**

ISO-Size	A	B	C	D	E	F	G	H
1	84	43	G1/4	10.5	21.5	10	32	98
2	95	56	G3/8	14	26	13	40	112
3	119	68	G1/2	17	17	18	32	136

ISO-Size	J	K	L	M	N	O	P	Q
1	48	5,5	110	10.5	23,5	24	G1/8	58
2	57	6,6	124	14	30	30	G1/8	74
3	71	6,6	149	17	22	32	G1/8	90

### Order Instructions Form A

ISO-Size	Weight (kg)	Order Instructions	
		Type	Order No.
1	0.160	S9-1-A	KX 9076
2	0.280	S9-2-A	KX 9433
3	0.570	S9-3-A	KX 9434

Dimensions in mm



Single Base Plates Form B – Type: S9 --B

## Base Plates

to ISO 5599  
Size 1, 2, 3

Versions:  
– Single Base Plates  
to VDMA 24345 Form B

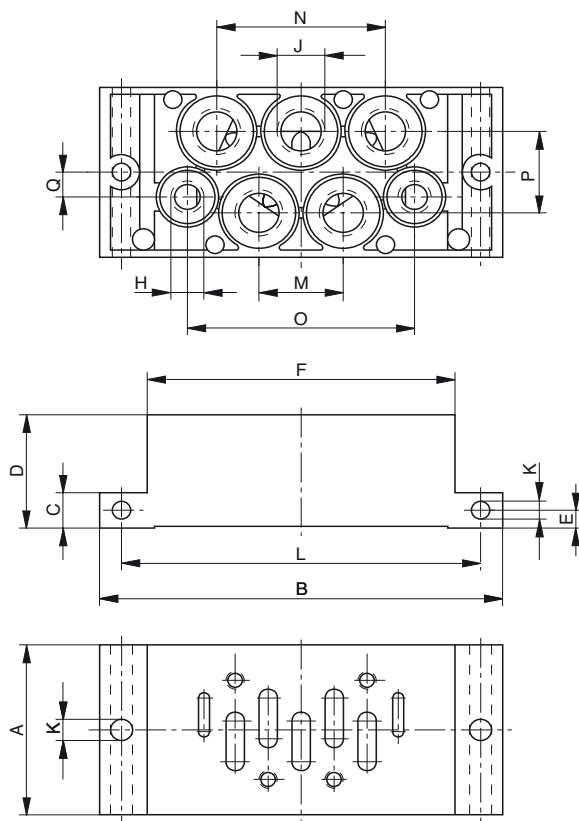

**Dimension Table Single Base Plates Form B**

ISO-Size	A	B	C	D	E	F	H	J
1	46	110	10	30	5	84	G1/8	G1/4
2	56	124	13	35	6,5	95	G1/8	G3/8
3	71	149	18	32	9	119	G1/8	G1/2

ISO-Size	K	L	M	N	O	P	Q
1	5,5	98	23	46	62	23	7.5
2	6,6	112	28	56	73	27	7.5
3	6,6	136	34	68	90	35	10

**Order Instructions Form B**

ISO-Size	Weight (kg)	Order Instructions	
		Type	Order No.
1	0.370	S9-1-B	KX 9077
2	0.590	S9-2-B	KX 9436
3	0.900	S9-3-B	KX 9437

Dimensions in mm



## Modules for Base Plate Combinations

to ISO 5599  
Size 1, 2, 3

### Versions

to VDMA 24345

- End Plate set, Form D, for Intermediate Plate, Form C
- Intermediate Plate, Form C
- Angle Base Plates Form E for for Intermediate Plate Form C
- Accessories

### End Plate Set Form D for Intermediate Plate – Order Instructions and Weight

ISO-Size	Weight (kg)	Order Instructions		Figure
		Type	Order No.	
1	0.210	S9-1-D	KX 9078	
2	0.360	S9-2-D	KX 9421	
3	0.680	S9-3-D	KX 9422	

The delivery includes: End Plate Set, completely with screws

### Intermediate Plate Form C – Order Instructions and Weight

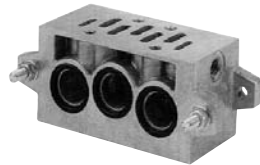
ISO-Size	Weight (kg)	Order Instructions		Figure
		Type	Order No.	
1	0.240	S9-1-C	KX 9079	
2	0.360	S9-2-C	KX 9419	
3	0.700	S9-3-C	KX 9420	

The delivery includes: Intermediate Plate, completely with O-rings and screws

### Angle Base Plate Form E for Intermediate Plate Form C

Dimension Table

Figure

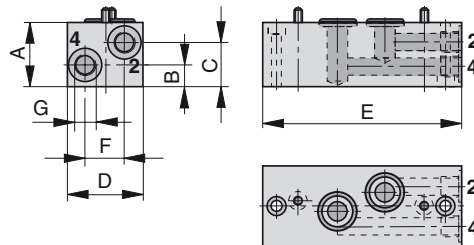

### Order Instructions and Dimension Table (mm)

Order Instructions		ISO-Size	A	B	C	D	E	F	G
Type	Order No.								
S9-1-E	KX 9081	1	37	12	25	42	110	22	G1/4
-	-	2	-	-	-	-	-	-	-
S9-3-E	KX 9425	3	45	17	29	70	190	36	G1/2

The delivery includes: Angle Base Plate, completely with O-rings and screws

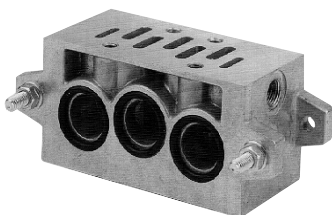

Dimensions in mm

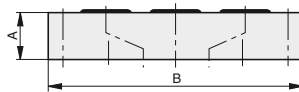

### Adapter Plate for Linkage of ISO-Sizes 1, 2, 3 – Dimension Table and Order Instructions

Order Instructions		for ISO Size	A	B	Width	Figure
Type	Order No.					
S9-1-2-KP	KX 9430	1 to 2	20	135	45	
S9-2-3-KP	KX 9431	2 to 3	25	190	55	
S9-1-3-KP	KX 9432	1 to 3	35	190	50	

**The delivery includes:** Adapter Plate with O-Rings and washers

### Dummy Plate – Dimension Table and Order Instructions

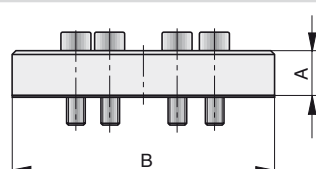
Order Instructions		for ISO Size	A	B	Width	Figure
Type	Order No.					
S9-1-BP	KX 9082	1	12	70	40	
S9-2-BP	KX 9423	2	12	90	55	
S9-3-BP	KX 9424	3	12	110	70	

**The delivery includes:** Dummy Plate with gasket and screws

### Plug – Order Instructions

Order Instructions		for ISO Size	Figure
Type	Order No.		
S9-1-VS	KX 5789	1	
S9-2-VS	KX 9426	2	
S9-3-VS	KX 9427	3	

Dimensions in mm

# Connection-platten

to ISO 5599  
size 1, 2, 3

**Versions**

to VDMA 24345

- End Plate set Form D for Intermediate Plate Form C
- Intermediate Plate Form C
- Angle Base Plates Form E for Intermediate Plate Form C
- Accessories

Example of Plate Combination

