



Non-return valves

Applications

Legris non-return valves allow fluids to pass in one direction whilst blocking flow in the other direction. They can be used both for hydraulic circuits and for compressed air applications and are an essential complementary range of Legris high pressure couplings.



Principle and advantages

Non-return valves are designed with a 90° cone face and an elastomer seal ensuring **perfect sealing**. In the open position, the cross-sectional flow area of non-return valves is not reduced and enables **full fluid flow with reduced pressure loss**. Efficiency of the valve is guaranteed with a maximum flow of 4 to 5 m/s.

The different versions of Legris non-return valves are :

- valves for assembly on screwed couplings (flow towards screwed plug or flow from screwed plug)
- straight coupling valves for assembly on hydraulic tubing
- double female valves, BSP parallel

All valves are marked with flow direction and valve opening pressure. Legris non-return valves are supplied with a standard valve opening pressure of 1 bar. Valves with alternative opening pressures are available on request (0,2 bar / 0,5 bar / 2 bar / 3 bar).

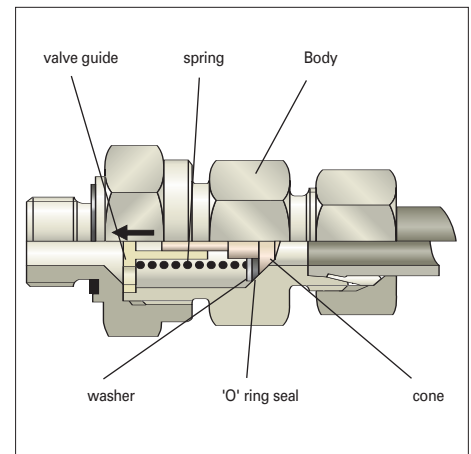

132

Choosing a non-return valve

The non-return valve must be selected according to the flow required by the hydraulic application. You will find below the curves showing pressure loss, dependant on the working fluid, with a valve opening pressure of 1 bar:

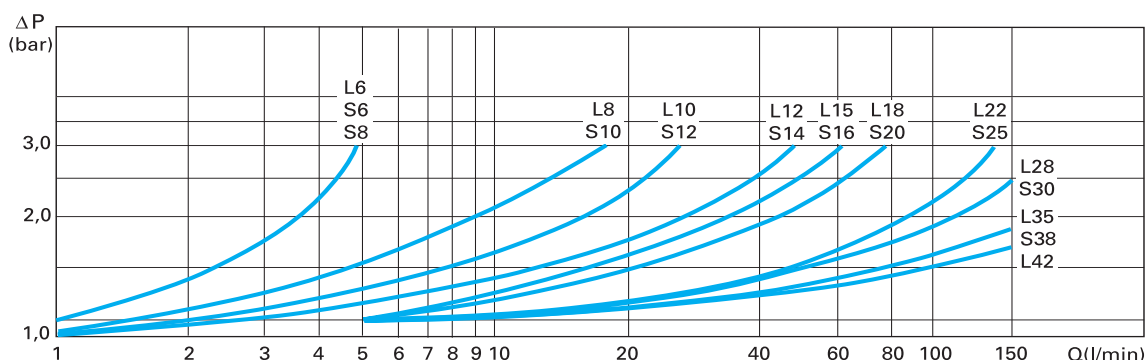

Product range

flow towards screwed plug

8280
BSP parallel



134

8280
metric parallel



135

flow from screwed plug

8281
BSP parallel



136

8281
metric parallel



137

straight coupling (non-return valves)

8282

133



138

double female (non-return valves)

8083
BSP parallel



139

Non-return valves, flow towards screwed plug

BSP parallel
elastomer seal
ISO 1179-2

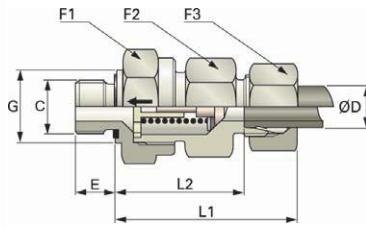

	PB	ØD	C	Body only	Double-bite ring	DiNova ring	Bell code	E	F1	F2	F3	G	L1	L2	kg
L	250	6	G1/8	8080L06 10	8280L06 10	8380L06 10	ZS15/A-52/L6RD	8	17	17	14	13,9	41	26,5	0,051
		8	G1/4	8080L08 13	8280L08 13	8380L08 13	ZS15/A-52/L8RD	12	19	17	17	18,9	43	28,5	0,065
		10	G1/4	8080L10 13	8280L10 13	8380L10 13	ZS15/A-52/L10RD	12	24	22	19	18,9	53	38,5	0,085
		12	G3/8	8080L12 17	8280L12 17	8380L12 17	ZS15/A-52/L12RD	12	30	27	22	21,9	55	40,5	0,180
		15	G1/2	8080L15 21	8280L15 21	8380L15 21	ZS15/A-52/L15RD	14	30	27	27	26,9	58	42,5	0,210
	160	18	G1/2	8080L18 21	8280L18 21	8380L18 21	ZS15/A-52/L18RD	14	36	36	32	26,9	64	48	0,320
		22	G3/4	8080L22 27	8280L22 27	8380L22 27	ZS15/A-52/L22RD	16	46	41	36	31,9	72	56	0,490
		28	G1	8080L28 34	8280L28 34	8380L28 34	ZS15/A-52/L28RD	18	55	50	41	39,9	81	64	0,770
	100	35	G1"1/4	8080L35 42	8280L35 42	8380L35 42	ZS15/A-52/L35RD	20	60	60	50	49,9	92	70	1,140
		42	G1"1/2	8080L42 49	8280L42 49	8380L42 49	ZS15/A-52/L42RD	22	70	65	60	54,9	93	70,5	1,510
S	400	6	G1/4	8080S06 13	8280S06 13	8380S06 13	ZS15/A-52/S6RD	12	19	19	17	18,9	46	31,5	0,075
		8	G1/4	8080S08 13	8280S08 13	8380S08 13	ZS15/A-52/S8RD	12	22	19	19	18,9	46	31,5	0,085
		10	G3/8	8080S10 17	8280S10 17	8380S10 17	ZS15/A-52/S10RD	12	27	24	22	21,9	54	38	0,150
		12	G3/8	8080S12 17	8280S12 17	8380S12 17	ZS15/A-52/S12RD	12	30	27	24	21,9	57	41	0,180
		14	G1/2	8080S14 21	8280S14 21	8380S14 21	ZS15/A-52/S14RD	14	32	27	27	26,9	61	43,5	0,252
		16	G1/2	8080S16 21	8280S16 21	8380S16 21	ZS15/A-52/S16RD	14	36	32	30	26,9	64	46	0,325
		20	G3/4	8080S20 27	8280S20 27	8380S20 27	ZS15/A-52/S20RD	16	46	41	36	31,9	72	50	0,590
	250	25	G1	8080S25 34	8280S25 34	8380S25 34	ZS15/A-52/S25RD	18	50	46	46	39,9	79	54,5	0,820
		30	G1"1/4	8080S30 42	8280S30 42	8380S30 42	ZS15/A-52/S30RD	20	60	55	50	49,9	91	64	1,155
		38	G1"1/2	8080S38 49	8280S38 49	8380S38 49	ZS15/A-52/S38RD	22	70	65	60	54,9	102	71,5	1,615

Non-return valves, flow towards screwed plug

metric parallel
elastomer seal
ISO 9974-2

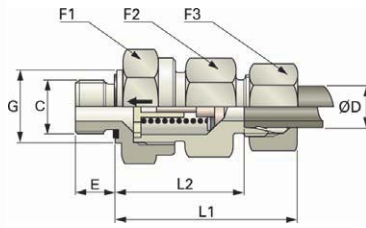

	PB	ØD	C	Body only	Double-bite ring	DiNova ring	Bell code	E	F1	F2	F3	G	L1	L2	kg
L	250	6	M10x1	8080L06 60	8280L06 60	8380L06 60	ZS15/A-52/L6MD	8	17	17	14	13,9	41	26,5	0,051
		8	M12x1,5	8080L08 67	8280L08 67	8380L08 67	ZS15/A-52/L8MD	12	19	17	17	16,9	43	28,5	0,065
		10	M14x1,5	8080L10 71	8280L10 71	8380L10 71	ZS15/A-52/L10MD	12	24	22	19	18,9	53	38,5	0,085
		12	M16x1,5	8080L12 75	8280L12 75	8380L12 75	ZS15/A-52/L12MD	12	30	27	22	21,9	55	40,5	0,180
		15	M18x1,5	8080L15 78	8280L15 78	8380L15 78	ZS15/A-52/L15MD	12	30	27	27	23,9	58	42,5	0,210
	160	18	M22x1,5	8080L18 82	8280L18 82	8380L18 82	ZS15/A-52/L18MD	14	36	36	32	26,9	64	48	0,320
		22	M26x1,5	8080L22 89	8280L22 89	8380L22 89	ZS15/A-52/L22MD	16	46	41	36	31,9	72	56	0,490
		28	M33x2	8080L28 91	8280L28 91	8380L28 91	ZS15/A-52/L28MD	18	55	50	41	39,9	81	64	0,770
		35	M42x2	8080L35 96	8280L35 96	8380L35 96	ZS15/A-52/L35MD	20	60	60	50	49,9	92	70	1,140
		42	M48x2	8080L42 98	8280L42 98	8380L42 98	ZS15/A-52/L42MD	22	70	65	60	54,9	93	70,5	1,510
S	400	6	M12x1,5	8080S06 67	8280S06 67	8380S06 67	ZS15/A-52/S6MD	12	19	19	17	16,9	46	31,5	0,075
		8	M14x1,5	8080S08 71	8280S08 71	8380S08 71	ZS15/A-52/S8MD	12	22	19	19	18,9	46	31,5	0,085
		10	M16x1,5	8080S10 75	8280S10 75	8380S10 75	ZS15/A-52/S10MD	12	27	24	22	21,9	54	38	0,150
		12	M18x1,5	8080S12 78	8280S12 78	8380S12 78	ZS15/A-52/S12MD	12	30	27	24	23,9	57	41	0,180
		14	M20x1,5	8080S14 80	8280S14 80	8380S14 80	ZS15/A-52/S14MD	14	32	27	27	25,9	61	43,5	0,252
	250	16	M22x1,5	8080S16 82	8280S16 82	8380S16 82	ZS15/A-52/S16MD	14	36	32	30	26,9	64	46	0,325
		20	M27x2	8080S20 86	8280S20 86	8380S20 86	ZS15/A-52/S20MD	16	46	41	36	31,9	72	50	0,590
		25	M33x2	8080S25 91	8280S25 91	8380S25 91	ZS15/A-52/S25MD	18	50	46	46	39,9	79	54,5	0,820
		30	M42x2	8080S30 96	8280S30 96	8380S30 96	ZS15/A-52/S30MD	20	60	55	50	49,9	91	64	1,155
		38	M48x2	8080S38 98	8280S38 98	8380S38 98	ZS15/A-52/S38MD	22	70	65	60	54,9	102	71,5	1,615

Discover it on legris.com

- A dynamic catalogue of the complete range - to **consult** and, through which, to request a **quotation**.
- A technical guide with **animated presentations** of product ranges.
- More than 3000 CAD drawings available.

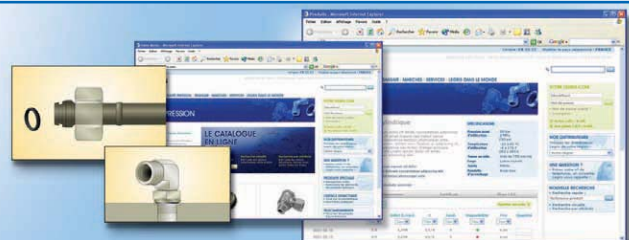

Non-return valves, flow from screwed plug

BSP parallel
elastomer seal
ISO 1179-2

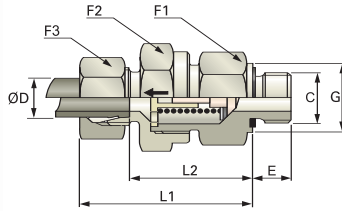

	PB	ØD	C	Body only	Double-bite ring	DiNova ring	Bell code	E	F1	F2	F3	G	L1	L2	kg
L	250	6	G1/8	8081L06 10	8281L06 10	8381L06 10	ZS15/E-52/L6RD	8	17	17	14	13,9	43	28	0,050
		8	G1/4	8081L08 13	8281L08 13	8381L08 13	ZS15/E-52/L8RD	12	19	19	17	18,9	45	30	0,072
		10	G1/4	8081L10 13	8281L10 13	8381L10 13	ZS15/E-52/L10RD	12	22	24	19	18,9	53	38,5	0,090
		12	G3/8	8081L12 17	8281L12 17	8381L12 17	ZS15/E-52/L12RD	12	27	30	22	21,9	57	42,5	0,185
		15	G1/2	8081L15 21	8281L15 21	8381L15 21	ZS15/E-52/L15RD	14	27	30	27	26,9	61	45,5	0,225
	160	18	G1/2	8081L18 21	8281L18 21	8381L18 21	ZS15/E-52/L18RD	14	36	36	32	26,9	66	50	0,335
		22	G3/4	8081L22 27	8281L22 27	8381L22 27	ZS15/E-52/L22RD	16	41	46	36	31,9	71	55	0,500
		28	G1	8081L28 34	8281L28 34	8381L28 34	ZS15/E-52/L28RD	18	50	55	41	39,9	80	63	0,785
	100	35	G1"1/4	8081L35 42	8281L35 42	8381L35 42	ZS15/E-52/L35RD	20	60	60	50	49,9	91	69	1,152
		42	G1"1/2	8081L42 49	8281L42 49	8381L42 49	ZS15/E-52/L42RD	22	65	70	60	54,9	91	68,5	1,510
S	400	6	G1/4	8081S06 13	8281S06 13	8381S06 13	ZS15/E-52/S6RD	12	19	19	17	18,9	46	31,5	0,090
		8	G1/4	8081S08 13	8281S08 13	8381S08 13	ZS15/E-52/S8RD	12	19	22	19	18,9	46	31,5	0,115
		10	G3/8	8081S10 17	8281S10 17	8381S10 17	ZS15/E-52/S10RD	12	24	27	22	21,9	54	38	0,150
		12	G3/8	8081S12 17	8281S12 17	8381S12 17	ZS15/E-52/S12RD	12	27	30	24	21,9	57	41	0,185
		14	G1/2	8081S14 21	8281S14 21	8381S14 21	ZS15/E-52/S14RD	14	27	32	27	26,9	62	44,5	0,255
	250	16	G1/2	8081S16 21	8281S16 21	8381S16 21	ZS15/E-52/S16RD	14	32	36	30	26,9	66	48	0,320
		20	G3/4	8081S20 27	8281S20 27	8381S20 27	ZS15/E-52/S20RD	16	41	46	36	31,9	74	52	0,595
		25	G1	8081S25 34	8281S25 34	8381S25 34	ZS15/E-52/S25RD	18	46	50	46	39,9	79	54,5	0,780
		30	G1"1/4	8081S30 42	8281S30 42	8381S30 42	ZS15/E-52/S30RD	20	55	60	50	49,9	91	64	1,170
		38	G1"1/2	8081S38 49	8281S38 49	8381S38 49	ZS15/E-52/S38RD	22	65	70	60	54,9	100	69,5	1,630

Non-return valves, flow from screwed plug

metric parallel
elastomer seal
ISO 9974-2

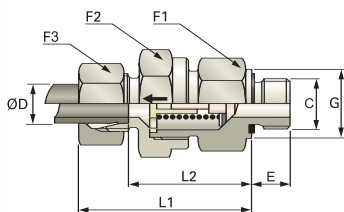

	PB	ØD	C	Body only	Double-bite ring	DiNova ring	Bell code	E	F1	F2	F3	G	L1	L2	kg	
L	250	6	M10x1	8081L06 60	8281L06 60	8381L06 60	ZS15/E-52/L6MD	8	17	17	14	13,9	43	28	0,050	
		8	M12x1,5	8081L08 67	8281L08 67	8381L08 67	ZS15/E-52/L8MD	12	17	19	17	16,9	44	29	0,072	
		10	M14x1,5	8081L10 71	8281L10 71	8381L10 71	ZS15/E-52/L10MD	12	22	24	19	18,9	53	38,5	0,090	
		12	M16x1,5	8081L12 75	8281L12 75	8381L12 75	ZS15/E-52/L12MD	12	27	30	22	21,9	57	42,5	0,185	
		15	M18x1,5	8081L15 78	8281L15 78	8381L15 78	ZS15/E-52/L15MD	12	27	30	27	23,9	61	45,5	0,225	
	160	18	M22x1,5	8081L18 82	8281L18 82	8381L18 82	ZS15/E-52/L18MD	14	36	36	32	26,9	66	50	0,335	
		22	M26x1,5	8081L22 89	8281L22 89	8381L22 89	ZS15/E-52/L22MD	16	41	46	36	31,9	71	55	0,500	
		100	28	M33x2	8081L28 91	8281L28 91	8381L28 91	ZS15/E-52/L28MD	18	50	55	41	39,9	80	63	0,785
			35	M42x2	8081L35 96	8281L35 96	8381L35 96	ZS15/E-52/L35MD	20	60	60	50	49,9	91	69	1,152
			42	M48x2	8081L42 98	8281L42 98	8381L42 98	ZS15/E-52/L42MD	22	65	70	60	54,9	91	68,5	1,510
S	400	6	M12x1,5	8081S06 67	8281S06 67	8381S06 67	ZS15/E-52/S6MD	12	19	19	17	16,9	46	31,5	0,090	
		8	M14x1,5	8081S08 71	8281S08 71	8381S08 71	ZS15/E-52/S8MD	12	19	22	19	18,9	46	31,5	0,115	
		10	M16x1,5	8081S10 75	8281S10 75	8381S10 75	ZS15/E-52/S10MD	12	24	27	22	21,9	54	38	0,150	
		12	M18x1,5	8081S12 78	8281S12 78	8381S12 78	ZS15/E-52/S12MD	12	27	30	24	23,9	57	41	0,185	
		14	M20x1,5	8081S14 80	8281S14 80	8381S14 80	ZS15/E-52/S14MD	14	27	32	27	25,9	62	44,5	0,255	
	250	16	M22x1,5	8081S16 82	8281S16 82	8381S16 82	ZS15/E-52/S16MD	14	32	36	30	26,9	66	48	0,320	
		20	M27x2	8081S20 86	8281S20 86	8381S20 86	ZS15/E-52/S20MD	16	41	46	36	31,9	74	52	0,595	
		25	M33x2	8081S25 91	8281S25 91	8381S25 91	ZS15/E-52/S25MD	18	46	50	46	39,9	79	54,5	0,780	
		30	M42x2	8081S30 96	8281S30 96	8381S30 96	ZS15/E-52/S30MD	20	55	60	50	49,9	91	64	1,170	
		38	M48x2	8081S38 98	8281S38 98	8381S38 98	ZS15/E-52/S38MD	22	65	70	60	54,9	100	69,5	1,630	

Non-return valves, straight coupling

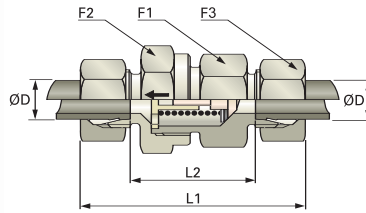



PB	ØD				Bell code	F1	F2	F3	L1	L2	
		Body only	Double-bite ring	DiNova ring							
L	6	8082L06 00	8282L06 00	8382L06 00	ZS15-53/L6	17	17	14	58	29	0,065
	8	8082L08 00	8282L08 00	8382L08 00	ZS15-53/L8	17	19	17	59	30	0,080
	10	8082L10 00	8282L10 00	8382L10 00	ZS15-53/L10	22	24	19	70	40,5	0,140
	12	8082L12 00	8282L12 00	8382L12 00	ZS15-53/L12	27	30	22	73	43,5	0,210
	15	8082L15 00	8282L15 00	8382L15 00	ZS15-53/L15	27	30	27	78	47,5	0,250
	18	8082L18 00	8282L18 00	8382L18 00	ZS15-53/L18	36	36	32	84	51,5	0,400
	22	8082L22 00	8282L22 00	8382L22 00	ZS15-53/L22	41	46	36	94	61,5	0,610
	28	8082L28 00	8282L28 00	8382L28 00	ZS15-53/L28	50	55	41	103	69,5	0,830
	35	8082L35 00	8282L35 00	8382L35 00	ZS15-53/L35	60	60	50	118	74,5	1,705
	42	8082L42 00	8282L42 00	8382L42 00	ZS15-53/L42	65	70	60	118,5	73,5	1,820
S	6	8082S06 00	8282S06 00	8382S06 00	ZS15-53/S6	19	19	17	64	34,5	0,095
	8	8082S08 00	8282S08 00	8382S08 00	ZS15-53/S8	19	22	19	64	34,5	0,110
	10	8082S10 00	8282S10 00	8382S10 00	ZS15-53/S10	24	27	22	73	40,5	0,180
	12	8082S12 00	8282S12 00	8382S12 00	ZS15-53/S12	27	30	24	75	42,5	0,215
	14	8082S14 00	8282S14 00	8382S14 00	ZS15-53/S14	27	32	27	83	47,5	0,300
	16	8082S16 00	8282S16 00	8382S16 00	ZS15-53/S16	32	36	30	87	50,5	0,400
	20	8082S20 00	8282S20 00	8382S20 00	ZS15-53/S20	41	46	36	98	54,5	0,690
	25	8082S25 00	8282S25 00	8382S25 00	ZS15-53/S25	46	50	46	107	58,5	1,020
	30	8082S30 00	8282S30 00	8382S30 00	ZS15-53/S30	55	60	50	123	69,5	1,380
	38	8082S38 00	8282S38 00	8382S38 00	ZS15-53/S38	65	70	60	137	75,5	1,940

non-return valves double female

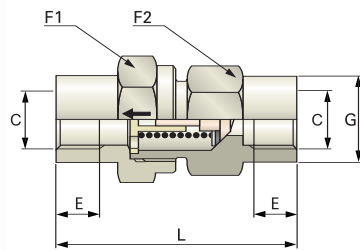
BSP parallel



PB	C		Bell code	F1	F2	G	L	E	
400	G1/8	8083 00 10	15-55/R1/8"	19	19	19	42,5	8	0,085
	G1/4	8083 00 13	15-55/R1/4"	19	19	19	51	12	0,100
	G3/8	8083 00 17	15-55/R3/8"	27	24	24	60	12	0,195
	G1/2	8083 00 21	15-55/R1/2"	36	32	32	72	15	0,350
	G3/4	8083 00 27	15-55/R3/4"	46	41	41	84	16,5	0,660
250	G1	8083 00 34	15-55/R1"	50	46	46	95	19	0,830
	G1"1/4	8083 00 42	15-55/R1 1/4"	60	55	55	110	21,5	1,420
	G1"1/2	8083 00 49	15-55/R1 1/2"	70	65	65	114	22	1,900