

Vacuum Products



Vacuum Pads



Vacuum Ejectors



Vacuum Sensors

Accessories



Vacuum pads

- Flat & Bellow Pads
- Male & Female Connections
- Different Materials
- Range of Diameters



Flat Pads - PFG

Ø (mm)	Order code
1	PFG-1-NBR
1,5	PFG-1.5-NBR
2	PFG-2A-NBR
3,5	PFG-3.5A-NBR
5	PFG-5A-NBR
6	PFG-6A-NBR
8	PFG-8A-NBR
10	PFG-10A-NBR
15	PFG-15A-NBR
20	PFG-20B-NBR
25	PFG-25-NBR
30	PFG-30-NBR
35	PFG-35-NBR
40	PFG-40-NBR
50	PFG-50-NBR
60	PFG-60-NBR
80	PFG-80-NBR
95	PFG-95-NBR
120	PFG-120-NBR
150	PFG-150-NBR
200	PFG-200-NBR



Flat Pads - Male Connection - PFTM

Ø (mm)	Thread	Order code
2	M5	PFTM-2A-NBR-M5
3,5	M5	PFTM-3.5A-NBR-M5
5	M5	PFTM-5A-NBR-M5
5	G1/8	PFTM-5A-NBR-G1
6	M5	PFTM-6A-NBR-M5
6	G1/8	PFTM-6A-NBR-G1
8	M5	PFTM-8A-NBR-M5
8	G1/8	PFTM-8A-NBR-G1
10	M5	PFTM-10A-NBR-M5
10	G1/8	PFTM-10A-NBR-G1
15	M5	PFTM-15A-NBR-M5
15	G1/8	PFTM-15A-NBR-G1
20	G1/8	PFTM-20B-NBR-G1
20	G1/4	PFTM-20B-NBR-G2
25	G1/8	PFTM-25-NBR-G1
25	G1/4	PFTM-25-NBR-G2
30	G1/8	PFTM-30-NBR-G1
30	G1/4	PFTM-30-NBR-G2
35	G1/8	PFTM-35-NBR-G1
35	G1/4	PFTM-35-NBR-G2
40	G1/8	PFTM-40-NBR-G1
40	G1/4	PFTM-40-NBR-G2
50	G1/8	PFTM-50-NBR-G1
50	G1/4	PFTM-50-NBR-G2
60	G1/4	PFTM-60-NBR-G2
80	G1/4	PFTM-80-NBR-G2
95	G1/4	PFTM-95-NBR-G2



Flat Pads - Female Connection - PFTF

Ø (mm)	Thread	Order code
5	G1/8	PFTF-5A-NBR-G1
6	G1/8	PFTF-6A-NBR-G1
8	G1/8	PFTF-8A-NBR-G1
10	G1/8	PFTF-10A-NBR-G1
15	G1/8	PFTF-15A-NBR-G1
20	G1/8	PFTF-20B-NBR-G1
20	G1/4	PFTF-20B-NBR-G2
25	G1/8	PFTF-25-NBR-G1
25	G1/4	PFTF-25-NBR-G2
30	G1/8	PFTF-30-NBR-G1
30	G1/4	PFTF-30-NBR-G2
35	G1/8	PFTF-35-NBR-G1
35	G1/4	PFTF-35-NBR-G2
40	G1/8	PFTF-40-NBR-G1
40	G1/4	PFTF-40-NBR-G2
50	G1/8	PFTF-50-NBR-G1
50	G1/4	PFTF-50-NBR-G2
60	G1/4	PFTF-60-NBR-G2
80	G1/4	PFTF-80-NBR-G2
95	G1/4	PFTF-95-NBR-G2
120	G1/2	PFTF-120-NBR-G4
150	G1/2	PFTF-150-NBR-G4
200	G1/2	PFTF-200-NBR-G4



Flat Pads - Reinforced Female Connection - CFS

Ø (mm)	Thread	Order code
20	M5	P5V-CFS02035N
30	M5	P5V-CFS03035N
50	G1/8	P5V-CFS05011N
75	G1/4	P5V-CFS07512N
100	G3/8	P5V-CFS10013N
150	G1/2	P5V-CFS15014N
300	G1	P5V-CFS30018N



 Indicates stocked product.

1.1/2 Bellow Pads - PBG

Ø (mm)	Order code
10	PBG-10A-NBR
15	PBG-15A-NBR
20	PBG-20B-NBR
30	PBG-30-NBR
40	PBG-40-NBR
50	PBG-50-NBR
75	PBG-75-NBR
110	PBG-110-NBR
150	PBG-150-NBR



1.1/2 Bellow Pads - Male Connection - PBTM

Ø (mm)	Thread	Order code
10	M5	PBTM-10A-NBR-M5
10	G1/8	PBTM-10A-NBR-G1
15	M5	PBTM-15A-NBR-M5
15	G1/8	PBTM-15A-NBR-G1
20	G1/8	PBTM-20B-NBR-G1
20	G1/4	PBTM-20B-NBR-G2
30	G1/8	PBTM-30-NBR-G1
30	G1/4	PBTM-30-NBR-G2
40	G1/8	PBTM-40-NBR-G1
40	G1/4	PBTM-40-NBR-G2
50	G1/8	PBTM-50-NBR-G1
50	G1/4	PBTM-50-NBR-G2
75	G1/4	PBTM-75-NBR-G2



1.1/2 Bellow Pads - Female Connection - PBTF

Ø (mm)	Thread	Order code
10	G1/8	PBTF-10A-NBR-G1
15	G1/8	PBTF-15A-NBR-G1
20	G1/8	PBTF-20B-NBR-G1
20	G1/4	PBTF-20B-NBR-G2
30	G1/8	PBTF-30-NBR-G1
30	G1/4	PBTF-30-NBR-G2
40	G1/8	PBTF-40-NBR-G1
40	G1/4	PBTF-40-NBR-G2
50	G1/8	PBTF-50-NBR-G1
50	G1/4	PBTF-50-NBR-G2
75	G1/4	PBTF-75-NBR-G2
110	G1/2	PBTF-110-NBR-G4
150	G1/2	PBTF-150-NBR-G4



2.1/2 Bellow Pads - PCG

Ø (mm)	Order code
5	PCG-5-NBR
7	PCG-7-NBR
9	PCG-10-NBR
14	PCG-15-NBR
18	PCG-18-NBR
20	PCG-20-NBR
32	PCG-30-NBR
42	PCG-40-NBR
62	PCG-60-NBR
88	PCG-90-NBR



2.1/2 Bellow Pads - Male Connection - PCTM

Ø (mm)	Thread	Order code
5	M5	PCTM-5-NBR-M5
5	G1/8	PCTM-5-NBR-G1
7	M5	PCTM-7-NBR-M5
7	G1/8	PCTM-7-NBR-G1
9	M5	PCTM-10-NBR-M5
9	G1/8	PCTM-10-NBR-G1
14	M5	PCTM-15-NBR-M5
14	G1/8	PCTM-15-NBR-G1
18	M5	PCTM-18-NBR-M5
18	G1/8	PCTM-18-NBR-G1
20	M5	PCTM-20-NBR-M5
20	G1/8	PCTM-20-NBR-G1
32	G1/8	PCTM-30-NBR-G1
32	G1/4	PCTM-30-NBR-G2
42	G1/8	PCTM-40-NBR-G1
42	G1/4	PCTM-40-NBR-G2
62	G1/8	PCTM-60-NBR-G1
62	G1/4	PCTM-60-NBR-G2
88	G1/4	PCTM-90-NBR-G2

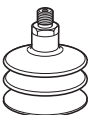

2.1/2 Bellow Pads - Female Connection - PCTF

Ø (mm)	Thread	Order code
5	G1/8	PCTF-5-NBR-G1
7	G1/8	PCTF-7-NBR-G1
9	G1/8	PCTF-10-NBR-G1
14	G1/8	PCTF-15-NBR-G1
18	G1/8	PCTF-18-NBR-G1
20	G1/8	PCTF-20-NBR-G1
32	G1/8	PCTF-30-NBR-G1
32	G1/4	PCTF-30-NBR-G2
42	G1/8	PCTF-40-NBR-G1
42	G1/8	PCTF-40-NBR-G2
62	G1/8	PCTF-60-NBR-G1
62	G1/4	PCTF-60-NBR-G2
88	G1/4	PCTF-90-NBR-G2

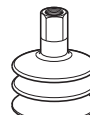

Other materials than NBR (nitrile) available
SI (silicone)
U (urethane)

 Indicates stocked product.

Vacuum ejectors

- Basic Ejectors
- Basic Ejectors with electro-mechanical Switch
- In-line Ejectors
- Integrated Ejectors small & large



In-line Ejectors - MCA

	Vac %	Vac flow NI/min.	Order code
	86	5	MCA05HST6T6G1
	86	5	MCA05HST6T6T6
	60	9	MCA05LST6T6G1
	60	9	MCA05LST6T6T6
	86	11,5	MCA07HST6T6G1
	86	11,5	MCA07HST6T6T6
	50	19,5	MCA07LST6T6G1
	50	19,5	MCA07LST6T6T6
	90	25	MCA10HST6T6G2
	90	25	MCA10HST6T6T8
	60	37	MCA10LST6T6G2
	60	37	MCA10LST6T6T8
	92	35	MCA13HST6T6G2
	92	35	MCA13HST6T6T8

Ejector incl. blow-off - CV-VR

	Vac %	Vac flow NI/min.	Order code
	92	63	CV15HSVRG

Basic Ejectors - CV

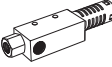
	Vac %	Vac flow NI/min.	Order code
	86	6	CV05HSG
	57	9	CV05LSG
	91	27	CV10HSG
	57	36	CV10LSG
	91	63	CV15HSG
	57	95	CV15LSG
	91	110	CV20HSG
	57	165	CV20LSG
	91	160	CV25HSG
	57	250	CV25LSG
	91	225	CV30AHSG
	57	350	CV30ALSG

Ejectors with electro-mech. switch - CV-CK

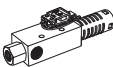
	Vac %	Vac flow NI/min.	Order code
	86	6	CV05HSCKG
	57	9	CV05LSCKG
	91	27	CV10HSCKG
	57	36	CV10LSCKG
	91	63	CV15HSCKG
	57	95	CV15LSCKG
	91	110	CV20HSCKG
	57	165	CV20LSCKG

Basic Ejectors - GAR

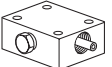
	Vac %	Vac flow NI/min.	Order code
	85	36	P5V-GAR0312
	85	53	P5V-GAR0614
	85	120	P5V-GAR1214
	85	290	P5V-GAR2414
	85	480	P5V-GAR4216
	85	600	P5V-GAR7214

Ejectors incl. AirSaver - GWV

	Vac %	Vac flow NI/min.	Order code
	90	14	P5V-GWV0214
	90	32	P5V-GWV0314
	90	50	P5V-GWV0414
	90	88	P5V-GWV0614

 Indicates stocked product.

Integrated Ejectors - (Small) - MC2

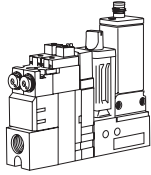

Vac %	Vac flow NI/min.	Order code	Order code Sensor
86	5,5	MC2S05HSZL24B5G	
86	5,5	MC2S05HS12L24B5G	MPS-V1E-PC
86	5,5	MC2S05HS02L24B5G	MVS-201-PCP
53	10,5	MC2S05LSZL24B5G	
53	10,5	MC2S05LS12L24B5G	MPS-V1E-PC
53	10,5	MC2S05LS02L24B5G	MVS-201-PCP
86	11	MC2S07HSZL24B5G	
86	11	MC2S07HS12L24B5G	MPS-V1E-PC
86	11	MC2S07HS02L24B5G	MVS-201-PCP
53	20,5	MC2S07LSZL24B5G	
53	20,5	MC2S07LS12L24B5G	MPS-V1E-PC
53	20,5	MC2S07LS02L24B5G	MVS-201-PCP
86	20	MC2S10HSZL24B5G	
86	20	MC2S10HS12L24B5G	MPS-V1E-PC
86	20	MC2S10HS02L24B5G	MVS-201-PCP

Integrated Ejectors - (Large) - CVK

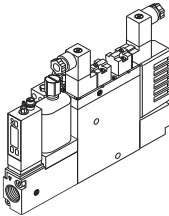

Vac %	Vac flow NI/min.	Order code	Order code Sensor
90	60	CVK15HSZC24BDG	
90	60	CVK15HS22C24BDG	MPS-V2G-PC
90	60	CVK15HS02C24BDG	MVS-201-PCP
90	60	CVK15HS62C24BDG	MPS-V6C-PC
55	90	CVK15LSZC24BDG	
55	90	CVK15LS22C24BDG	MPS-V2G-PC
55	90	CVK15LS02C24BDG	MVS-201-PCP
55	90	CVK15LS62C24BDG	MPS-V6C-PC
90	100	CVK20HSZC24BDG	
90	100	CVK20HS22C24BDG	MPS-V2G-PC
90	100	CVK20HS02C24BDG	MVS-201-PCP
90	100	CVK20HS62C24BDG	MPS-V6C-PC
55	155	CVK20LSZC24BDG	
55	155	CVK20LS22C24BDG	MPS-V2G-PC
55	155	CVK20LS02C24BDG	MVS-201-PCP
55	155	CVK20LS62C24BDG	MPS-V6C-PC
90	150	CVK27HSZC24BDG	
90	150	CVK27HS22C24BDG	MPS-V2G-PC
90	150	CVK27HS02C24BDG	MVS-201-PCP
90	150	CVK27HS62C24BDG	MPS-V6C-PC

Moduflex Vacuum Generators - P2M

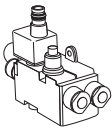

Order code for Size 1 vacuum generator (90% vac. - 25 NI/min)

Basic module	P2M1PXVA
I: 2 unions - V: 2 x 6mm straight - E: Silencer	P2M1PXVAJJAF6AMA
I: 2 unions - V: 6mm straight + plug - E: Silencer	P2M1PXVAJJAF6BMA
I: 2 x 6mm straight - V: 2 x 6mm straight - E: Silencer	P2M1PXVAF6AF6AMA
I: 2 x 6mm straight - V: 6mm straight + plug - E: Silencer	P2M1PXVAF6AF6BMA
I: 6mm straight + plug - V: 2 x 6mm straight - E: Silencer	P2M1PXVAF6BF6AMA
I: 6mm straight + plug - V: 6mm straight + plug - E: Silencer	P2M1PXVAF6BF6BMA

I = Input V = Vacuum E = Exhaust

 Indicates stocked product.

Vacuum sensors

- -1 to +10 bar
- Analog and/or Digital Outputs
- With display

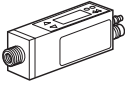

Sensors

	Pressure range	Output	Connection		Order code
			electrical	pneumatic	
	-1 to 0 bar	1 analog / 7 amp.	conn.	G1/8	P5V-SVVA16K
	-1 to 0 bar	1 analog & 1 digit	M8	G1/8	MPS-V1G-PC
	0 to +10 bar	1 analog & 1 digit	M8	G1/8	MPS-P1G-PC
	-1 to 0 bar	1 analog & 1 digit	M8	Flange	MPS-V1E-PC
	0 to +10 bar	1 analog & 1 digit	M8	Flange	MPS-P1E-PC
	-1 to 0 bar	1 digit	M8	Flange	MPS-V1E-PC3
	-1 to 0 bar	2 digit	M8	G1/8	MPS-V2G-PC
	0 to +10 bar	2 digit	M8	G1/8	MPS-P2G-PC
	-1 to 0 bar	2 digit	M8	G1/8	MPS-V3G-PC
	0 to +10 bar	2 digit	M8	G1/8	MPS-P3G-PC
	-1 to 0 bar	2 digit	M8	Tube	MPS-V6T-PC
	-1 to 0 bar	2 digit	Cable	Tube	MPS-V6T-PG
	-1 to 0 bar	2 digit	M8	G1/8	MPS-V6G-PC
	-1 to 0 bar	2 digit	Cable	G1/8	MPS-V6G-PG
	-1 to 0 bar	1 analog	Cable	Tube	MPS-V6T-AGE
	0 to +10 bar	1 analog	Cable	Tube	MPS-P6T-AGE
		Cable		MPS-71E-PG	
		Cable		MPS-74E-PG	

Vacuum accessories

- High performance silencers and vacuum filters
- Electronic cables with M8 connector 4 pin



Electronic cables

	Order code
	CB-M8-4P-2M
	CB-M8-4P-5M
	CB-M8-4P-5M-90

Silencers

Thread	Order code
G 3/4	MS6-01
G 1/2	MSL02
G 1/4	MSM-01
G 1/8	MSS-01

Vacuum filters

	Order code
	VF-11
	VF-2
	VF-3
	VF-5
	VF-6
	VFL-44
	VFL-66

Vacuum cut-off valve

Thread	Order code
M5	P5V-BKS35
G1/8	P5V-BKS11
G1/4	P5V-BKS12

Thread	Order code
G3/8	P5V-BKS13
G1/2	P5V-BKS14

 Indicates stocked product.